

**SHOWER**

**03**



**Colacril**

C

## **1** consegna veloce fast delivery

Consegnamo velocemente ogni ordine, perché sappiamo quanto siano importanti le tempistiche. Una consegna rapida ed efficace è il primo passo per fidelizzare il cliente.

We deliver orders quickly because we understand how crucial timing is. A fast and efficient delivery is the first step to build customer loyalty.



## **2** qualità al 100% 100% quality



100% quality

Una qualità indiscussa e un servizio di assistenza verso i clienti che rendono la nostra azienda una tra le più importanti dell'arredo bagno.

Unquestionable quality and customer care service make our company one of the leading for bathroom fittings.

## **3** certificazioni certifications



EN 14428: 2015+A1: 2018

Tutti i box doccia Colacril sono certificati secondo le indicazioni del CPR - Regolamento Prodotti da Costruzione (UE) 305/2011. La documentazione è a disposizione della clientela per verifica e controllo.

All Colacril shower boxes are certified according to the CPR - Construction Products Regulation (EU) 305/2011. The documentation is readily available to customers for verification and control.

## **4** vetro temperato tempered glass

La qualità dei materiali da noi utilizzati garantisce la massima sicurezza. Il trattamento termico per il vetro temperato ne aumenta le caratteristiche di resistenza meccanica e di resistenza allo shock termico, mentre lo spessore da 6 e 8 mm assicura piena stabilità al box. A voi la scelta.

The quality of materials we use ensures maximum safety. The heat treatment for tempered glass increases mechanical strength and resistance to thermal shock. A thickness ranging from 6 to 8 mm guarantees the full stability of the shower enclosure. It's up to you!



## **5** easy clean easy clean



easy clean

I vetri Colacril rispondono a criteri di qualità altissimi. Su tutti quelli con altezza 2 metri, viene applicato come dotazione di serie il trattamento EASY CLEAN, basato sulla nanotecnologia. La cura e la pulizia dei vetri si fanno così rapide e semplici.

Colacril glass meets very high-quality standards. For all those with a height of 2 meters, the EASY CLEAN treatment, based on nanotechnology, is applied as standard. This makes glass maintenance and cleaning quick and easy.

## **6** estensibilità extensibility

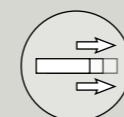

extensibility

Grazie ai profili in alluminio con spessore min. di 1,2 mm, l'estensibilità del box può variare da 1 a 5 cm in modo da potersi adattare su piatti più o meno grandi.

Thanks to its aluminum finishing 1,2 mm thick, the extensibility of the shower box can vary from 1 to 5 cm to adapt to bigger or smaller shower trays.

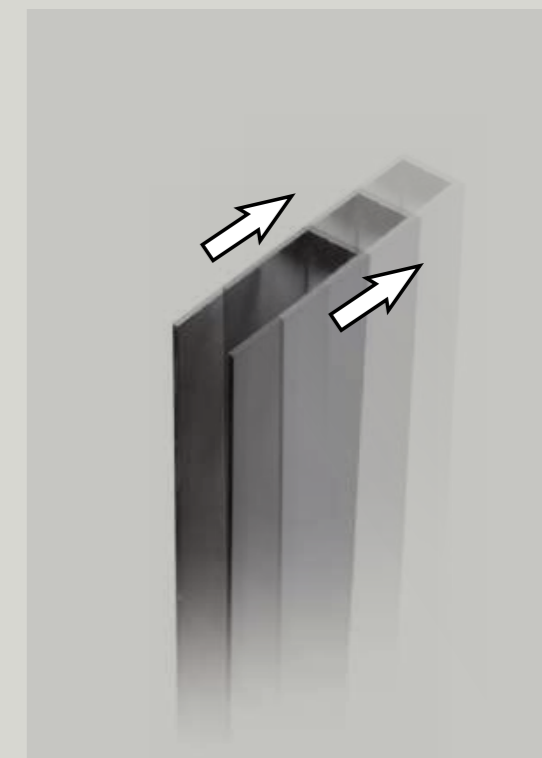

**\_7****sgancio rapido e scorrimento ante**  
fast-release and sliding door system

I modelli con ante scorrevoli sono dotate del sistema di sgancio rapido per facilitare la pulizia e del sistema di scorrimento su ruote in nylon con cuscinetti a sfera per una migliore scorrevolezza. Sono testati per durare nel tempo (10.000 aperture e 10.000 chiusure). Tutte le ante si possono regolare in altezza e inclinazione.

Sliding door models are provided with fast-release system in order to facilitate the cleaning of the roller sliding door fitting system equipped with ball bearing for better smoothness. They are tested to last over time (10.000 openings and 10.000 closings). All doors are angle and height adjustable.

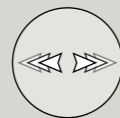
**\_8****soft close**  
soft close

soft close

Alcuni modelli con porta scorrevole della collezione sono dotate di chiusura SOFT CLOSE che facilita la chiusura senza sforzo o frizioni.

Some of sliding door models are provided with SOFT CLOSE system that facilitates closure without excessive force or friction.

**\_9****cerniere, profili e maniglie**  
hinges, profiles and handles

I profili parete sottili in alluminio cromo, le maniglie in lega cromate eleganti e le cerniere in ottone cromato minimalistiche sono perfettamente equilibrate e donano alle cabine doccia un look unico.

Chromed aluminum thin-walled profiles, elegant chrome-plated handles and minimalist brass hinges are perfectly balanced and enhance the unique look of shower.

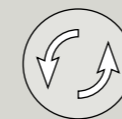
**\_10****reversibilità**  
reversibilityreversibile  
reversible

Tutti i box doccia hanno la possibilità di essere posizionati sia nella versione destra che sinistra in funzione delle necessità che il cliente ha.

All shower boxes can be placed both on the left and right side, according to customer needs.

**\_11****installazione rapida**  
rapid installation

Rapid/Quick/Easy è l'innovativo sistema di montaggio rapido sviluppato dal nostro ufficio tecnico, che permette una semplice ed intuitiva installazione del box doccia tramite pochi e semplici step. In questo modo chiunque, anche l'utente finale, è in grado di montare i box doccia Rapid/Quick/Easy.

Rapid/Quick/Easy is the innovative quick assembly system developed by our technical office, which allows a simple and intuitive installation of the shower stall through few simple steps. In this way anyone, even the end user, is able to install the Rapid/Quick/Easy shower stalls.

# index

## **box doccia 8 mm**

8 mm shower box

Porta scorrevole / Sliding door

**8PSC15** 10

Porta battente / Hinge door

**8MILL INFINITY** 18

Soluzioni aperte / Open solutions

**N8PAR53** 28

**N8PAR53 VETRO FUMÉ** 40

**8PAR53W WALK-IN BLACK** 44

**WALK-IN CON CERNIERE** 52

## **box doccia 6 mm**

6 mm shower box

Porta scorrevole / Sliding door

**RAPID** 60

**PSCRAPID** 66

**QUICK** 74

**PSCQUICK** 80

**EASYPSC50** 88

**FPSC57** 96

**EASYFLEX** 104

**FS40** 110

**ECO LATO** 116

**ECO SEM** 124

**ECOPSC50** 128

Porta battente / Hinge door

**SWING CROMO** 136

**SWING NERA** 144

**SWING ALLUMINIO SPAZZOLATO** 152

**TEPB43** 160

**FPB40** 166

**TPB72** 180

**TVB61** 186

Porta a saloon / Saloon door

**FPSL60** 192

**NSALOON S/PROFILI** 200

Porta a soffietto / Folding door

**FPS30** 208

**TPS35** 216

Soluzioni aperte / Open solutions

**PARETE CROMO WALK-IN** 228

**PARETE NERA WALK-IN** 236

**PARETE ALLUMINIO SPAZZOLATO WALK-IN** 244

Sopra vasca / Bathtub shower panel

**TSV50** 252

**TSV51** 256

**TSV52** 260

**TSV53** 264

## **piatti doccia**

shower trays

Ceramica / Ceramic

**CERAMIC.30** 270

Marmoresina / Marble-resin

**PLAN** 276

**FLAT** 280

**FLAT/BORDO** 286

Poliestere / Polyester

**SMC** 292

**ACRYLIC H3** 296

**ACRYLIC H5/BORDO** 302

**PANNELLI RIVESTIMENTO** 306

wall covering panels

## **colonne doccia**

shower columns

**LOIRA** 312

**SENNA** 314

**RIO** 316

**DANUBIO** 318

**VOLGA** 320

**PO** 322

**PRETORIA** 324

**NETTUNO** 326

**GAIA** 328

**SET QUADRO** 330

**RIPETTA** 332

**SIRENA** 334

**DIANA** 336

**SET TONDO** 338

**ANGELICA** 340

**SET RETTANGOLARE BLACK** 342

**TRITONE** 344

**SET TONDO BLACK** 346

## **accessori**

accessories

348

# box doccia 8 mm

## 8 mm shower box



### porta scorrevole

sliding door

<b>8PSC15</b>	<u>10</u>
nicchia / niche	11
angolare / corner	14

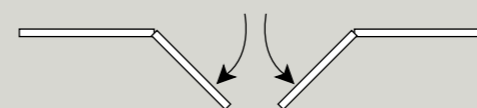

### doppia porta battente

double hinge door

<b>8MILL INFINITY</b>	<u>18</u>
nicchia / niche	19



### soluzioni aperte

open solutions

<b>N8PAR53</b>	<u>28</u>
cromo / chrome	29
grafite / graphite	32
oro / gold	34
bronzo / bronze	36
<b>N8PAR53 VETRO FUMÉ</b>	<u>40</u>
<b>8PAR53W WALK-IN BLACK</b>	<u>44</u>
<b>WALK-IN CON CERNIERE</b>	<u>52</u>

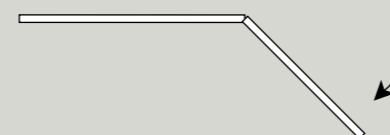

### porta battente

hinge door

<b>8MILL INFINITY</b>	<u>18</u>
nicchia / niche	22
angolare / corner	24

# 8PSC15

8PSC15 è un sistema cabina doccia ad anta scorrevole con telaio in alluminio lucido e vetro 8 mm. Il modello, esteticamente pulito, presenta un profilo squadrato e dettagli minimali ed eleganti come l'aggancio dei vetri e la maniglia.

8PSC15 is a shower enclosure system with sliding door, polished aluminum frame and 8 mm glass. The model is aesthetically clean, it has a square aluminum profile and other minimalistic and elegant details such as the way the glass doors attach and the handle.

## versioni\_versions

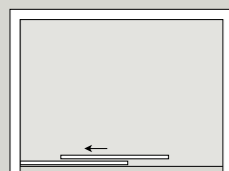

Porta scorrevole  
Versione: Nicchia

Sliding door  
Version: Niche

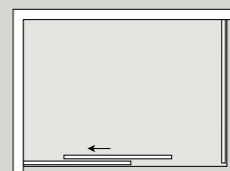

Porta scorrevole  
Versione: Angolo

Sliding door  
Version: Corner

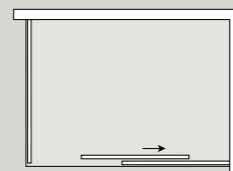

Porta scorrevole  
Versione: Angolo

Sliding door  
Version: Corner

## caratteristiche tecniche\_technical characteristics



easy clean

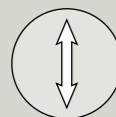

**h 2000 mm**  
altezza  
height

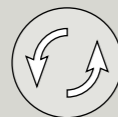

reversibile  
reversible

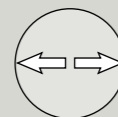

**25 mm**  
regolazione  
adjustment



**8 mm**  
cristallo temperato  
tempered glass

NTPA06



**+15 mm**  
profilo di allungamento  
adjustable profile



soft close

## finiture\_finishes



cromo  
chrome

## cristallo\_glass



Cristallo trasparente  
Transparent glass

box doccia 8 mm / 8 mm shower box



8PSC15  
nicchia\_niche



**Diana**  
colonna doccia  
shower column

**Flat**  
piatto doccia Bianco  
White shower tray



Disponibile in due tipologie di installazione, ad angolo e a nicchia, garantisce sicurezza e perfetta tenuta con un'altezza di 2000 mm. L'apertura e la chiusura Soft-Close garantiscono totale sicurezza all'utente. Può essere installato su piatti doccia tradizionali.

—  
This shower can be installed in a corner or in a niche. Safety and water-tight installation is guaranteed for the shower enclosure with a height of 2000 mm. Soft-Close offers total user safety. This shower enclosure can also be installed on traditional shower trays.





8PSC15 + 8KLF  
angolo\_corner



**Flat**  
piatto doccia Bianco  
White shower tray



# 8PSC15

Porta scorrevole\_Sliding door **H 2000 mm**

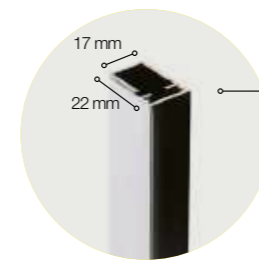
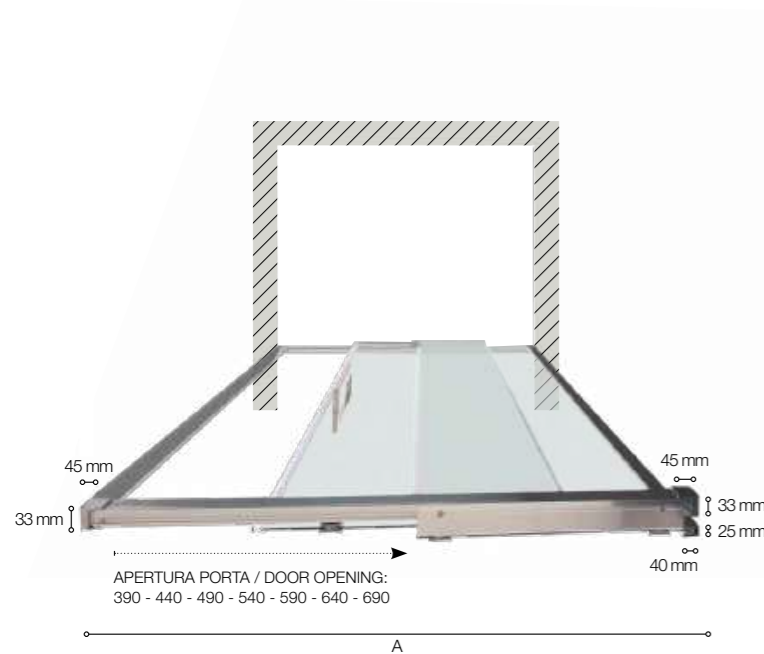

## NTPC02

Profilo chiusura /  
Closing profile

Per / For Art.  
8PSC15

Versione nicchia  
Niche Version

### DIMENSIONI PORTA (A) (NICCHIA) DOOR SIZE (A) (NICHE)

Specifiche tecniche / Technical specifications				
L/W mm	H/H mm	Peso vetro kg	Apertura porta	Estensibilità mm
		Glass weight kgs	Door Opening	Extension mm
1000	2000	46	390	970 - 995
1050	2000	50	390	1020 - 1045
1100	2000	51	440	1070 - 1095
1150	2000	54	440	1120 - 1145
1200	2000	56	490	1170 - 1195
1250	2000	58	490	1220 - 1245
1300	2000	60	540	1270 - 1295
1350	2000	62	540	1320 - 1345
1400	2000	65	590	1370 - 1395
1450	2000	67	590	1420 - 1445
1500	2000	69	640	1470 - 1495
1550	2000	70	640	1520 - 1545
1600	2000	72	690	1570 - 1595
1650	2000	74	690	1620 - 1645
1700	2000	88	690	1670 - 1695
1750	2000	90	690	1720 - 1745
1800	2000	94	690	1770 - 1795

### box doccia 8 mm / 8 mm shower box

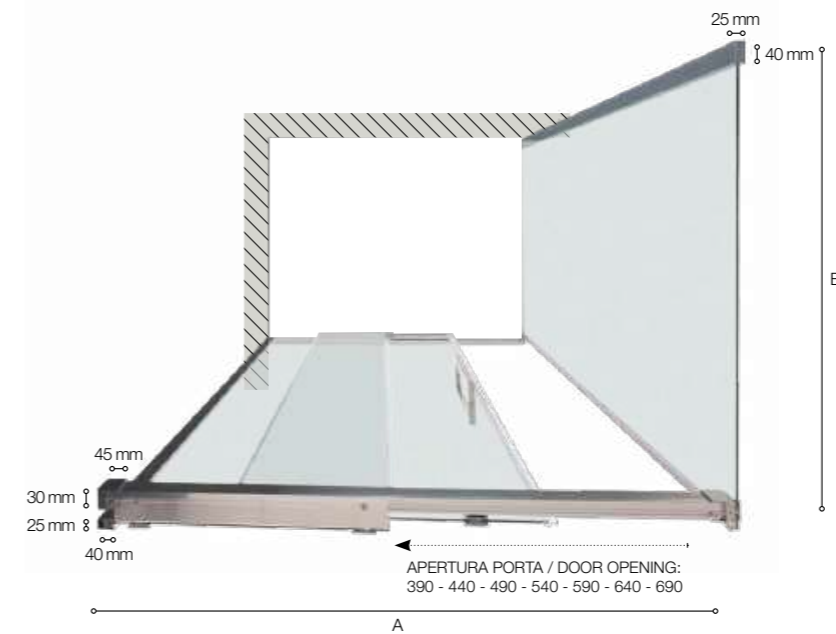

Versione Angolare SX da 1000 mm  
Left Corner Version 1000 mm

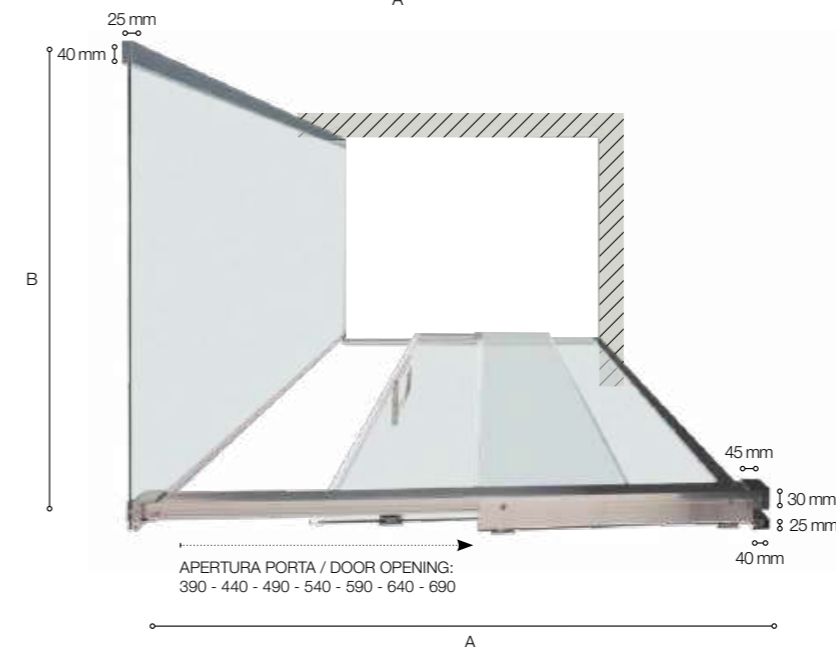

Versione Angolare DX da 1000 mm  
Right Corner Version 1000 mm

### PORTA ABBINATA A LATO FISSO DOOR MATCHED WITH FIXED PANEL

Specifiche tecniche / Technical specifications		
P/D mm	H/H mm	Estensibilità mm
		Extension mm
1000	2000	970 - 995
1050	2000	1020 - 1045
1100	2000	1070 - 1095
1150	2000	1120 - 1145
1200	2000	1170 - 1195
1250	2000	1220 - 1245
1300	2000	1270 - 1295
1350	2000	1320 - 1345
1400	2000	1370 - 1395
1450	2000	1420 - 1445
1500	2000	1470 - 1495
1550	2000	1520 - 1545
1600	2000	1570 - 1595
1650	2000	1620 - 1645
1700	2000	1670 - 1695
1750	2000	1720 - 1745
1800	2000	1770 - 1795

### DIMENSIONI LATO FISSO (B) FIXED SIDE PANEL SIZE (B)

Specifiche tecniche / Technical specifications			
P/D mm	H/H mm	Peso vetro kg	Estensibilità mm
		Glass weight kgs	Extension mm
700	2000	30	680 - 705
800	2000	32	770 - 795
900	2000	40	870 - 895

# 8MILL infinity

La caratteristica principale di 8MILL INFINITY è la sua predisposizione ad adattarsi a varie dimensioni e configurazioni, mantenendo inalterata la sua leggerezza e la sua pulizia estetica.

The main characteristic of the 8MILL INFINITY is the ability to adapt to various sizes and configurations while maintaining "lightness" and clean lines.

## versioni\_versions

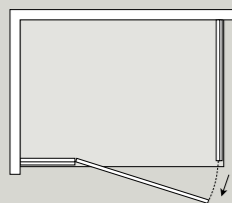

Porta battente  
Versione: Angolo

Single hinge door  
Version: Corner

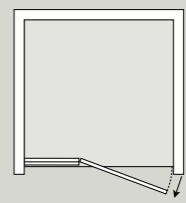

Porta battente  
Versione: Nicchia

Hinge door  
Version: Niche

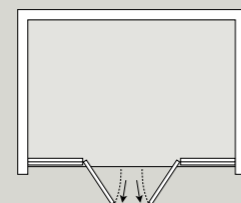

Doppia porta battente  
Versione: Nicchia

Double hinge door  
Version: Niche

## caratteristiche tecniche\_technical characteristics



easy clean

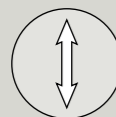

**h 2018 mm**  
altezza  
height

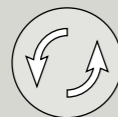

reversibile  
reversible

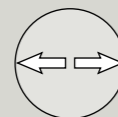

**20 mm**  
regolazione  
adjustment



**8 mm**  
cristallo temperato  
tempered glass



**NTPA07**  
**+20 mm**  
profilo di allungamento  
adjustable profile

## finiture\_finishes



cromo  
chrome

## cristallo\_glass



Cristallo trasparente  
Transparent glass

box doccia 8 mm / 8 mm shower box



8MILL infinity  
nicchia\_niche



**Nettuno**  
colonna doccia  
shower column

**Flat**  
piatto doccia Bianco  
White shower tray



Il telaio a parete assicura stabilità e sorregge lo spessore del vetro fisso da 8 mm che, grazie a due cerniere tecniche, resta libero dal profilo.

The frame, fixed to the wall, guarantees stability and supports the 8 mm fixed glass panel, that thanks to the two technical hinges, is frameless.



8MILL infinity  
nicchia\_niche



Rio  
colonna doccia  
shower column

Flat  
piatto doccia Crema  
Cream shower tray



**8MILL infinity + B8MILLA**  
angolo\_corner

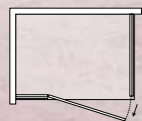

**Rio**  
colonna doccia  
shower column

**Flat**  
piatto doccia Bianco  
White shower tray



Questa cabina è dotata di una trasparenza totale che mette in evidenza dettagli ricercati come la maniglia. Può essere installato su piatti doccia tradizionali, filo pavimento o sopra pavimento.

—  
This shower enclosure offers total transparency that permits the details, such as the handle, to be highlighted. This enclosure can be installed on traditional shower trays of flush mounted shower trays.

# 8MILL Infinity

Porta battente\_Hinge door **H 2018 mm**

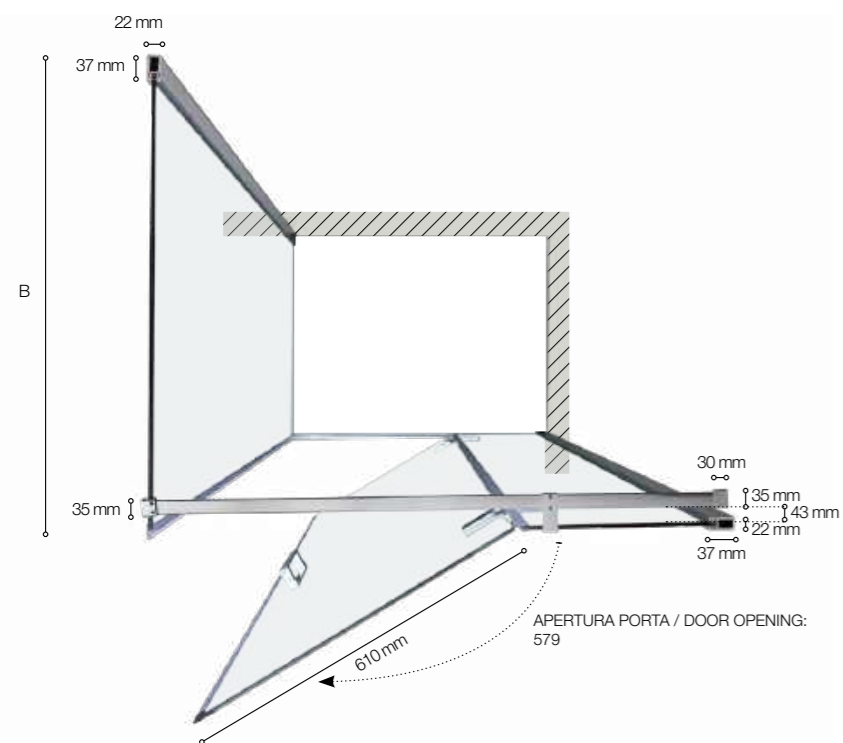

Versione angolare DX  
Right corner version

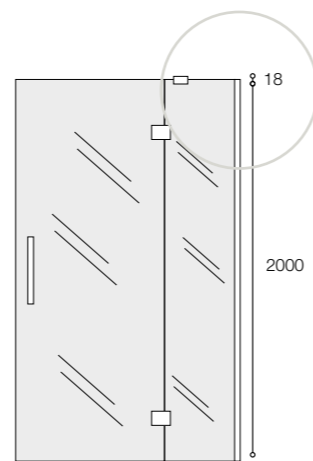

## PORTA ABBINATA A LATO FISSO DOOR MATCHED WITH FIXED PANEL

Specifiche tecniche / Technical specifications					
P/D mm	H/H mm	Peso vetro kg Glass weight kgs	Apertura porta Door opening	Ingombro porta Clumbed door	Estensibilità mm Extension mm
800	2018	28	579	610	762 - 782
900	2018	33	579	610	862 - 882
1000	2018	37	579	610	962 - 982
1100	2018	41	579	610	1062 - 1082
1200	2018	45	579	610	1162 - 1182
1300	2018	49	579	610	1262 - 1282
1400	2018	53	579	610	1362 - 1382
1500	2018	59	579	610	1462 - 1482
1600	2018	62	579	610	1562 - 1582
1700	2018	65	579	610	1662 - 1682
1800	2018	70	579	610	1762 - 1782

## DIMENSIONI LATO FISSO (B) FIXED SIDE PANEL SIZE (B)

Specifiche tecniche / Technical specifications			
P/D mm	H/H mm	Peso vetro kg Glass weight kgs	Estensibilità mm Extension mm
700	2018	29	670 - 690
800	2018	34	770 - 790
900	2018	38	870 - 890
1000	2018	42	970 - 990

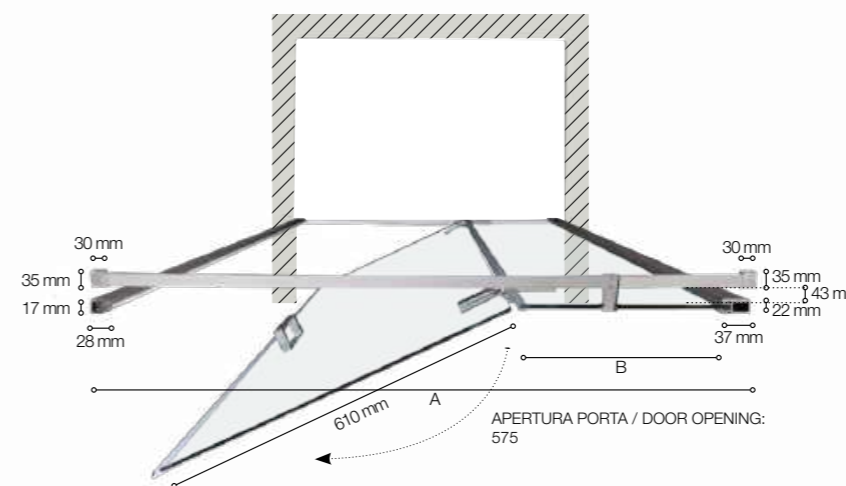

Versione nicchia  
Niche version

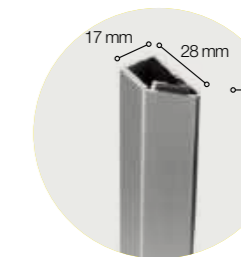

**NTPC03**

Profilo chiusura /  
Closing profile

Per / For Art.  
TEPB43 - TPS35 -  
TPB72 - SWING -  
INFINITY

## DIMENSIONI PORTA (A) (NICCHIA) DOOR SIZES (A) (NICHE)

Specifiche tecniche / Technical specifications						
P/D mm	H/H mm	Peso vetro kg Glass weight kgs	Apertura porta Door opening	Ingombro porta Clumbed door	Estensibilità mm Extension mm	B mm
800	2018	29	575	610	775 - 795	146
900	2018	34	575	610	875 - 895	246
1000	2018	38	575	610	975 - 995	346
1100	2018	42	575	610	1075 - 1095	446
1200	2018	46	575	610	1175 - 1195	546
1300	2018	50	575	610	1275 - 1295	646
1400	2018	54	575	610	1375 - 1395	746
1500	2018	60	575	610	1475 - 1495	846
1600	2018	63	575	610	1575 - 1595	946
1700	2018	66	575	610	1675 - 1695	1046
1800	2018	71	575	610	1775 - 1795	1146

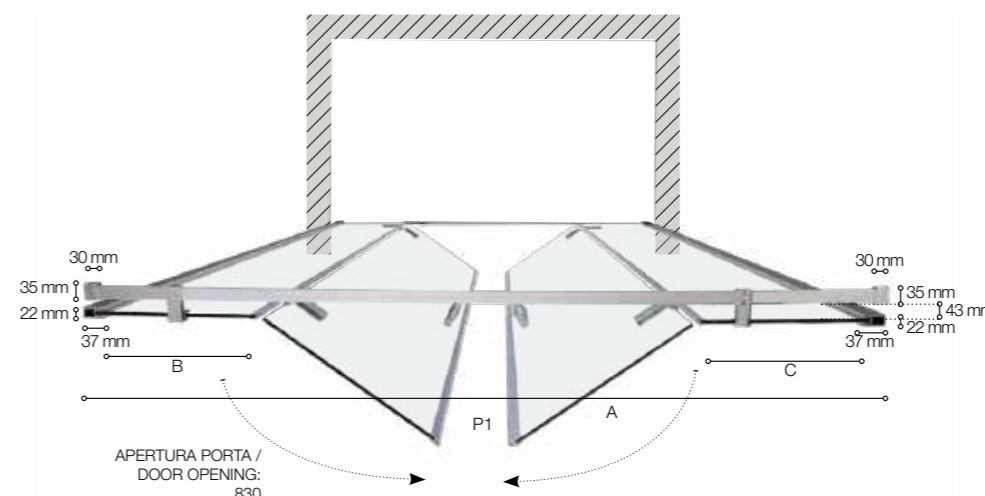

Versione nicchia  
Niche version

## DIMENSIONI PORTA (A) (NICCHIA DOPPIA ANTA) DOOR SIZES (A) (NICHE WITH TWO DOORS)

Specifiche tecniche / Technical specifications							
L/W mm	H/H mm	Peso vetro kg Glass weight kgs	Apertura porta Door opening	Ingombro porta Clumbed door	Estensibilità mm Extension mm	A mm	B mm
1200	2018	72	830	440	1168 - 1208	146	146
1300	2018	77	830	440	1268 - 1308	146	246
1400	2018	82	830	440	1368 - 1408	246	246
1500	2018	94	830	440	1468 - 1508	246	346
1600	2018	106	830	440	1568 - 1608	346	346
1700	2018	110	830	440	1668 - 1708	346	446
1800	2018	114	830	440	1768 - 1808	446	446
1900	2018	118	830	440	1868 - 1908	446	546
2000	2018	122	830	440	1968 - 2008	546	546

# N8PAR53

N8PAR53 è la cabina doccia per chi vuole l'eliminazione quasi totale di qualsiasi profilo. Nasce dall'evoluzione dell'arredo bagno e permette di valorizzare l'ambiente con la leggerezza.

N8PAR53 is for those who would like a frameless shower enclosure. Designed from the evolution of bathroom furnishings, it permits to enhance environmental lightness.

## versioni\_versions

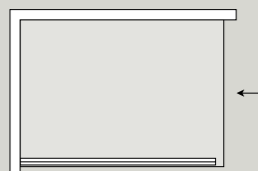

Soluzione aperta  
Versione: Walk-in

Open solution  
Version: Walk-in

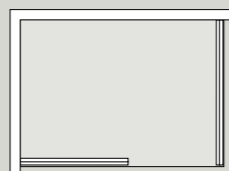

Soluzione aperta  
Versione: Doppia walk-in

Open solution  
Version: Double walk-in

## caratteristiche tecniche\_technical characteristics



easy clean

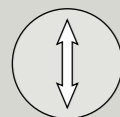

**h 2007 mm**  
altezza  
height

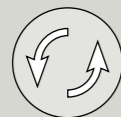

reversibile  
reversible

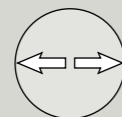

**20 mm**  
regolazione  
adjustment

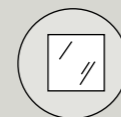

**8 mm**  
cristallo temperato  
tempered glass

## finiture\_finishes

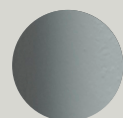

cromo  
chrome



grafite  
graphite



oro  
gold



bronzo  
bronze

## cristallo\_glass



Cristallo trasparente  
Transparent glass

box doccia 8 mm / 8 mm shower box



### N8PAR53 walk-in\_walk-in



**Diana**  
colonna doccia  
shower column

**Flat**  
piatto doccia Grigio cemento  
Concrete grey shower tray





**N8PAR53**  
doppia walk-in\_double walk-in

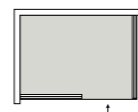

**Flat**  
piatto doccia Grigio cemento  
Concrete grey shower tray

L'essenzialità del design si unisce alla varietà di finiture disponibili (cromo, grafite, oro, bronzo). Ne risulta un prodotto estremamente versatile, capace di adattarsi con stile a ogni ambiente bagno.

The essentiality of design combines with the variety of available finishes (chrome, graphite, gold, bronze). The outcome is an extremely versatile product, capable of stylishly adapting to any bathroom environment.





**N8PAR53**  
doppia walk-in\_double walk-in



**Tritone**  
colonna doccia  
shower column

**Ceramic.30**  
piatto doccia Bianco matt  
White matt shower tray



**N8PAR53**  
walk-in\_walk-in

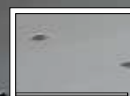

**Angelica**  
colonna doccia  
shower column

**Ceramic.30**  
piatto doccia Nero matt  
Black matt shower tray

Il profilo oro crea un interessante accento cromatico e illumina con discrezione i contorni del box doccia.

The gold profile creates an intriguing chromatic accent and delicately illuminates the outlines of the shower enclosure.



N8PAR53  
walk-in\_walk-in

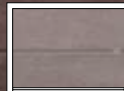

**Tritone**  
colonna doccia  
shower column

**Ceramic.30**  
piatto doccia Nero matt  
Black matt shower tray

CROMO\_CHROME



GRAFITE\_GRAPHITE



BRONZO\_BRONZE



ORO\_GOLD

# N8PAR53

Soluzione aperta\_Open solution **H 2007 mm**

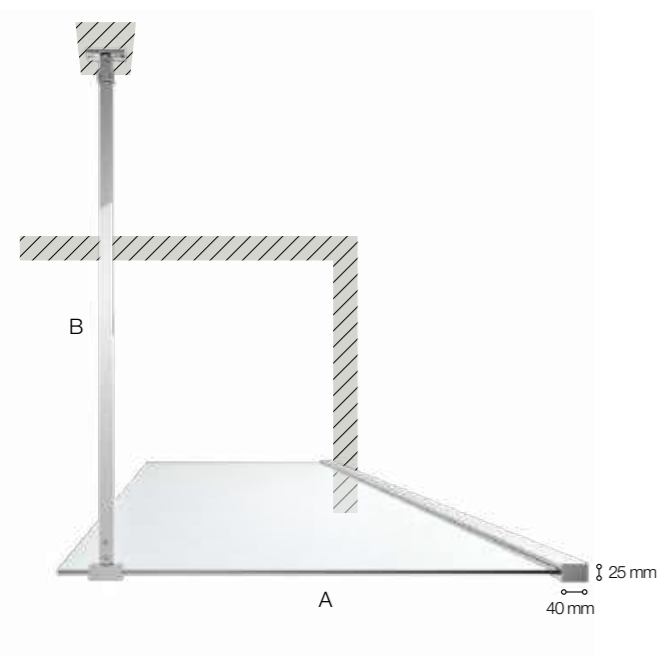

**WALK-IN**  
WALK-IN

**(B) Asta di fissaggio tagliabile, snodabile 1200 mm**  
(B) Cuttable, adjustable support arm 1200 mm

## Specifiche tecniche / Technical specifications

### Dimensioni (A) / Sizes (A)

L/W mm	H/H mm	Peso vetro kg	Estensibilità mm	Asta di fissaggio tagliabile mm (B)
		Glass weight kgs	Extension mm	Cuttable support arm mm (B)
700	2007	31	680 - 700	1200
800	2007	37	780 - 800	1200
900	2007	41	880 - 900	1200
1000	2007	45	980 - 1000	1200
1100	2007	49	1080 - 1100	1200
1200	2007	53	1180 - 1200	1200
1300	2007	57	1280 - 1300	1200
1400	2007	61	1380 - 1400	1200
1600	2007	69	1580 - 1600	1200

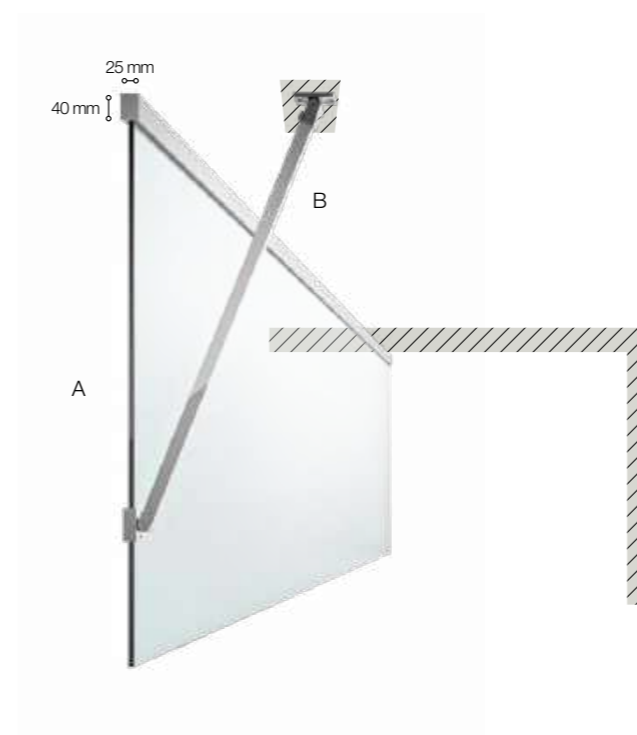

**WALK-IN**  
WALK-IN

**(B) Asta di fissaggio tagliabile, snodabile 1200 mm**  
(B) Cuttable, adjustable support arm 1200 mm

## Specifiche tecniche / Technical specifications

### Dimensioni (A) / Sizes (A)

L/W mm	H/H mm	Peso vetro kg	Estensibilità mm	Asta di fissaggio tagliabile mm (B)
		Glass weight kgs	Extension mm	Cuttable support arm mm (B)
700	2007	31	680 - 700	1200
800	2007	37	780 - 800	1200
900	2007	41	880 - 900	1200
1000	2007	45	980 - 1000	1200
1100	2007	49	1080 - 1100	1200
1200	2007	53	1180 - 1200	1200
1300	2007	57	1280 - 1300	1200
1400	2007	61	1380 - 1400	1200
1600	2007	69	1580 - 1600	1200

# N8PAR53

## vetro fumé

La leggerezza tipica della cabina doccia N8PAR53 si combina con l'utilizzo del cristallo fumé. L'atmosfera risulta morbida e accogliente nella sua essenzialità.

The typical visual lightness of the N8PAR53 shower cabin combines with the use of smoked glass. This creates a gentle and inviting atmosphere, with essential charm.

### versioni\_versions

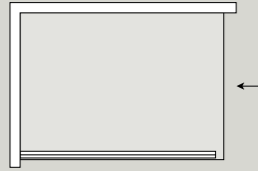

Soluzione aperta  
Versione: Walk-in

Open solution  
Version: Walk-in

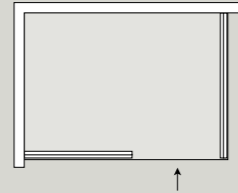

Soluzione aperta  
Versione: Doppia walk-in

Open solution  
Version: Double walk-in

### caratteristiche tecniche\_technical characteristics



easy clean

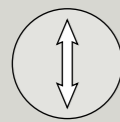

**h 2007 mm**  
altezza  
height

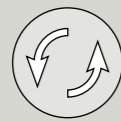

reversibile  
reversible

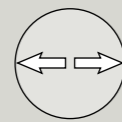

**20 mm**  
regolazione  
adjustment

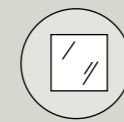

**8 mm**  
cristallo temperato  
tempered glass

### finiture\_finishes



nero matt  
black matt

### cristallo\_glass



Cristallo fumé  
Smoked glass

box doccia 8 mm / 8 mm shower box



N8PAR53  
walk-in\_walk-in

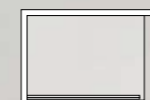

**Angelica**  
colonna doccia  
shower column

**Ceramic.30**  
piatto doccia Avorio matt  
Ivory matt shower tray

# N8PAR53 vetro fumé

Soluzione aperta\_Open solution **H 2007 mm**

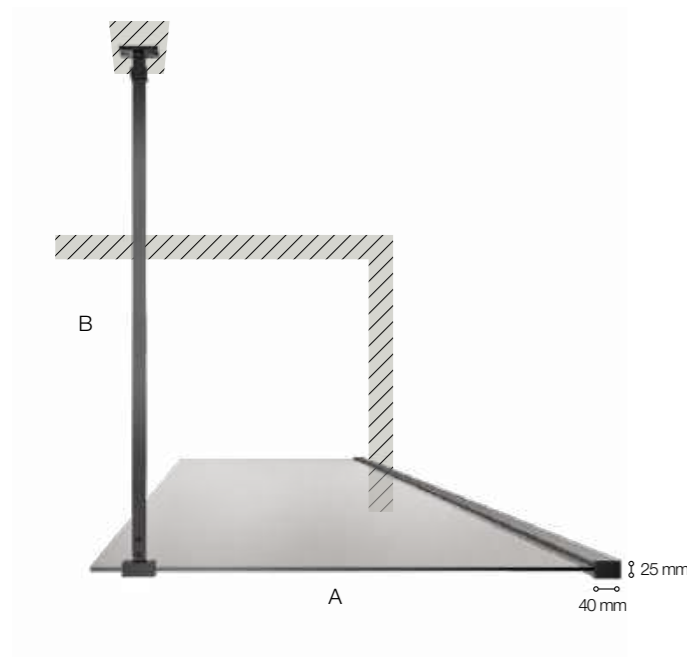

**WALK-IN**  
WALK-IN

**(B) Asta di fissaggio tagliabile, snodabile 1200 mm**  
(B) Cuttable, adjustable support arm 1200 mm

## Specifiche tecniche / Technical specifications

### Dimensioni (A) / Sizes (A)

L/W mm	H/H mm	Peso vetro kg	Estensibilità mm	Asta di fissaggio tagliabile mm (B)
		Glass weight kgs	Extension mm	Cuttable support arm mm (B)
700	2007	31	680 - 700	1200
800	2007	37	780 - 800	1200
900	2007	41	880 - 900	1200
1000	2007	45	980 - 1000	1200
1100	2007	49	1080 - 1100	1200
1200	2007	53	1180 - 1200	1200
1300	2007	57	1280 - 1300	1200
1400	2007	61	1380 - 1400	1200
1600	2007	69	1580 - 1600	1200

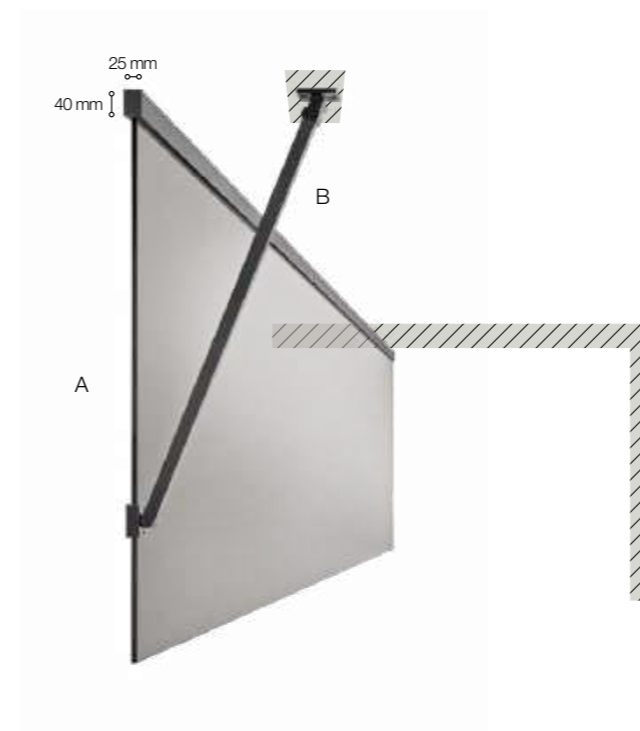

**WALK-IN**  
WALK-IN

**(B) Asta di fissaggio tagliabile, snodabile 1200 mm**  
(B) Cuttable, adjustable support arm 1200 mm

## Specifiche tecniche / Technical specifications

### Dimensioni (A) / Sizes (A)

L/W mm	H/H mm	Peso vetro kg	Estensibilità mm	Asta di fissaggio tagliabile mm (B)
		Glass weight kgs	Extension mm	Cuttable support arm mm (B)
700	2007	31	680 - 700	1200
800	2007	37	780 - 800	1200
900	2007	41	880 - 900	1200
1000	2007	45	980 - 1000	1200
1100	2007	49	1080 - 1100	1200
1200	2007	53	1180 - 1200	1200
1300	2007	57	1280 - 1300	1200
1400	2007	61	1380 - 1400	1200
1600	2007	69	1580 - 1600	1200

# 8PAR53W

## walk-in black

8PAR53W è un sistema completamente aperto, arricchito dal particolare disegno con modello "a finestra" delle pareti fisse, che disegna e caratterizza l'architettura dell'ambiente bagno.

8PAR53W is a fully opened system, enriched by the peculiar "window" design of the fixed sides, which draws and characterizes the architecture of the bathroom.

### versioni\_versions

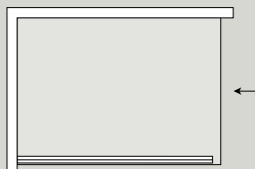

Soluzione aperta  
Versione: Walk-in

Open solution  
Version: Walk-in

### caratteristiche tecniche\_technical characteristics



easy clean

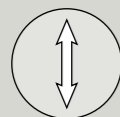

**h 2003 mm**  
altezza  
height



reversibile  
reversible

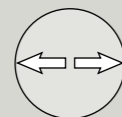

**20 mm**  
regolazione  
adjustment



**8 mm**  
cristallo temperato  
tempered glass

### finiture\_finishes



nero matt  
black matt

### cristallo\_glass



Cristallo trasparente  
Transparent glass



8PAR53W  
walk-in\_walk-in

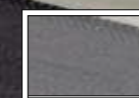

**Diana**  
colonna doccia  
shower column

**Flat**  
piatto doccia Bianco  
White shower tray





8PAR53W  
walk-in\_walk-in



Tritone  
colonna doccia  
shower column



8PAR53W  
walk-in\_walk-in

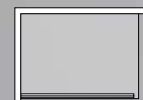

**Tritone**  
colonna doccia  
shower column

**Flat**  
piatto doccia Bianco  
White shower tray



Una cabina doccia walk-in caratterizzata da elementi fissi in cristallo, dotati di un originale disegno in profili neri e dall'assenza di porte. Un sistema che coniuga il rigore del design al più alto standard di resistenza.

A walk-in shower enclosure characterized by fixed crystal elements, equipped with very original black profiles and doorless. A system that combines a rigorous design with the highest resistance standards.

# 8PAR53W

Soluzione aperta\_Open solution **H 2003 mm**

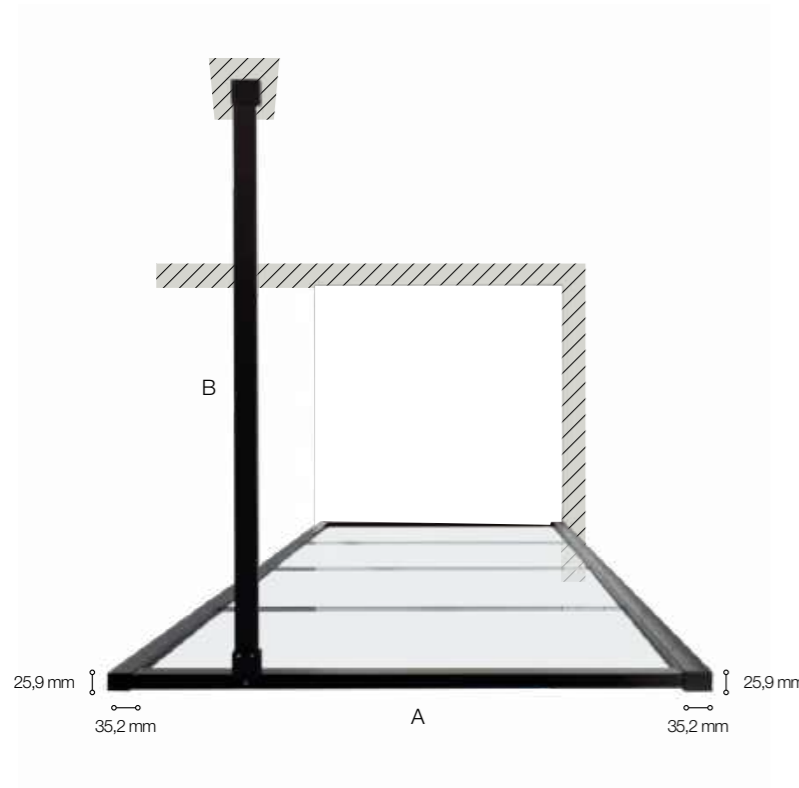

Versione 8PAR53W da 700/800/900 mm  
8PAR53W Version mm 700/800/900

**WALK-IN IN QUATTRO SEZIONI**  
WALK-IN IN FOUR SECTIONS

**(B) Asta di fissaggio non snodabile 1200 mm  
(con possibilità di taglio)**  
(B) 1200 mm not articulated support arm  
(with possibility of cutting)

## Specifiche tecniche / Technical specifications

### Dimensioni (A) / Sizes (A)

L/W mm	H/H mm	Peso vetro kg	Estensibilità mm	Asta di fissaggio tagliabile mm <b>(B)</b>
		Glass weight kgs	Extension mm	Cutttable support arm mm (B)
700	2003	31	675 - 695	1200
800	2003	35	775 - 795	1200
900	2003	40	875 - 895	1200

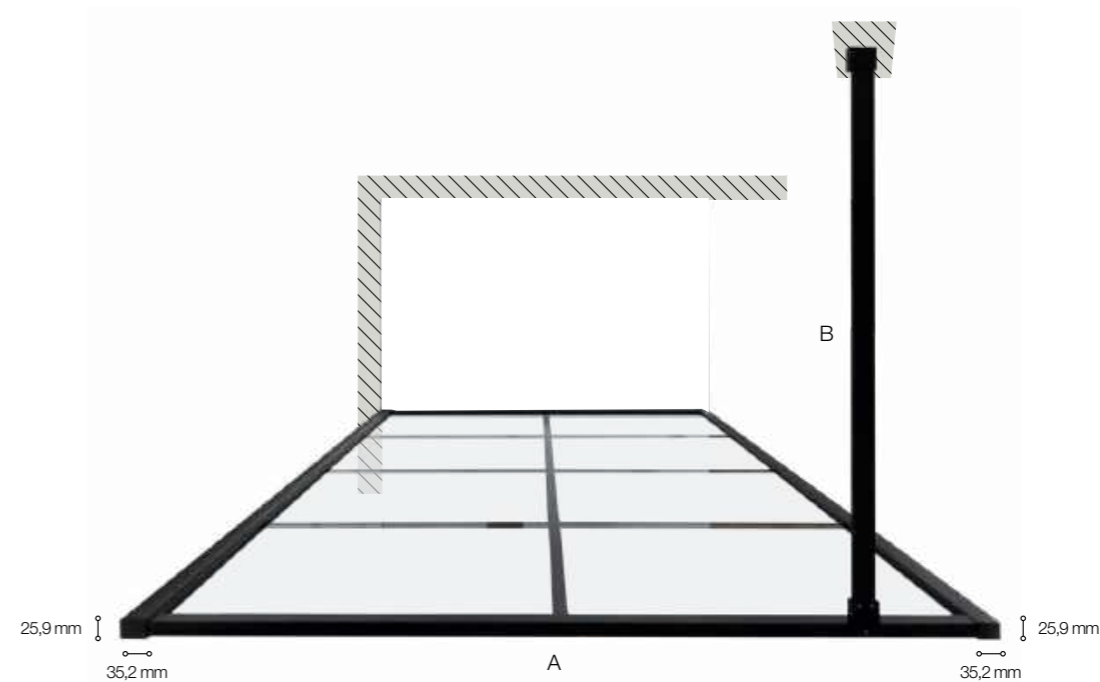

Versione 8PAR53W da 1000/1100/1200/1300/1400 mm  
8PAR53W Version mm 1000/1100/1200/1300/1400

**WALK-IN IN OTTO SEZIONI**  
WALK-IN IN EIGHT SECTIONS

**(B) Asta di fissaggio non snodabile 1200 mm  
(con possibilità di taglio)**  
(B) 1200 mm not articulated support arm  
(with possibility of cutting)

## Specifiche tecniche / Technical specifications

### Dimensioni (A) / Sizes (A)

L/W mm	H/H mm	Peso vetro kg	Estensibilità mm	Asta di fissaggio tagliabile mm <b>(B)</b>
		Glass weight kgs	Extension mm	Cutttable support arm mm (B)
1000	2003	45	975 - 995	1200
1100	2003	50	1075 - 1095	1200
1200	2003	53	1175 - 1195	1200
1300	2003	58	1275 - 1295	1200
1400	2003	61	1375 - 1395	1200

# WALK-IN

## con cerniere

Il profilo in alluminio spazzolato crea una cornice leggera. L'antina, visivamente sottolineata dalle cerniere, consente una parziale chiusura del box doccia. Walk-in con cerniera si adatta così con eleganza anche agli spazi ridotti e a diverse tipologie di installazione.

The brushed nickel profile creates a subtle frame. The door, visually emphasized by the hinges, allows for a partial closure of the shower enclosure. Walk-in with hinges elegantly adapts to limited spaces and various installation types.

### versioni\_versions

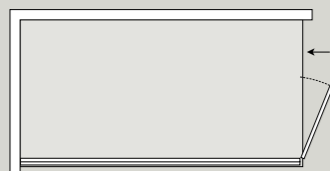

Soluzione aperta  
Versione: Walk-in con cerniere

Open solution  
Version: Walk-in with hinges

### caratteristiche tecniche\_technical characteristics



easy clean

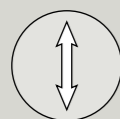

**h 2007 mm**  
altezza  
height

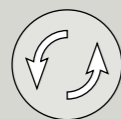

reversibile  
reversible

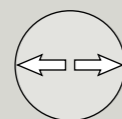

**25 mm**  
regolazione  
adjustment



**8 mm**  
cristallo temperato  
tempered glass

### finiture\_finish

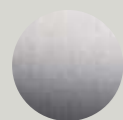

alluminio spazzolato  
brushed nickel

### cristallo\_glass



Cristallo trasparente  
Transparent glass



8 WALK-IN  
walk-in con cerniere\_walk-in with hinges

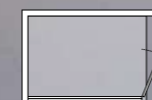

**Diana**  
colonna doccia  
shower column

**Ceramic.30**  
piatto doccia Bianco matt  
White matt shower tray

# Walk-in con cerniere

Soluzione aperta\_Open solution **H 2003 mm**

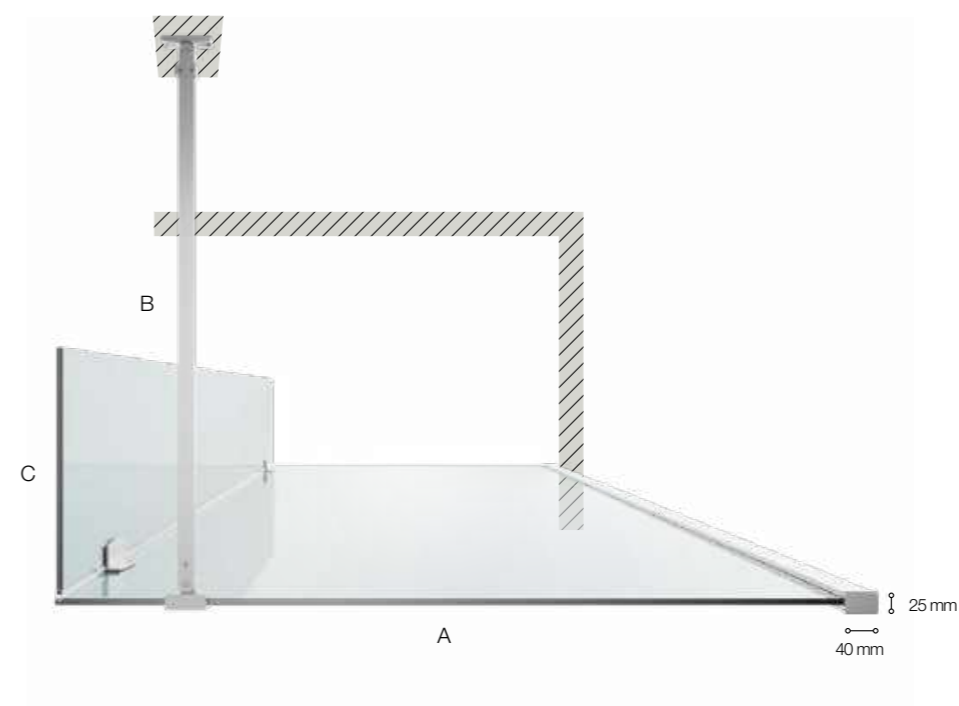

**WALK-IN**  
WALK-IN

**(B) Asta di fissaggio tagliabile, snodabile 1200 mm**  
(B) Cuttable, adjustable support arm 1200 mm

**ANTINA PER WALK-IN**  
ANTINA FOR WALK-IN

## Specifiche tecniche / Technical specifications

Dimensioni (A) / Sizes (A)				
L/W	H/H	Peso vetro kg	Estensibilità mm	Asta di fissaggio tagliabile mm (B)
mm	mm	Glass weight kgs	Extension mm	Cuttable support arm mm (B)
1000	2007	47	975 - 1000	1200
1100	2007	51	1075 - 1100	1200
1200	2007	55	1175 - 1200	1200
1300	2007	59	1275 - 1300	1200
1400	2007	63	1375 - 1400	1200

## Specifiche tecniche / Technical specifications

Dimensioni (C) / Sizes (C)		
L/W	H/H	Peso vetro kg
mm	mm	Glass weight kgs
300	2003	14
400	2003	16

# box doccia 6 mm

## 6 mm shower box

### rapid/quick/easy

58

#### porta scorrevole sliding door

<b>RAPID</b>	<b>60</b>
angolare / corner	61
centro parete / center wall	62
<b>PSCRAPID</b>	<b>66</b>
angolare / corner	67
centro parete / center wall	68
nicchia / niche	70
<b>QUICK</b>	<b>74</b>
angolare / corner	75
centro parete / center wall	76
<b>PSCQUICK</b>	<b>80</b>
centro parete / center wall	81
angolare / corner	82
nicchia / niche	84
<b>EASYPSC50</b>	<b>88</b>
centro parete / center wall	89
angolare / corner	90
nicchia / niche	92
<b>FPSC57</b>	<b>96</b>
centro parete / center wall	97
nicchia / niche	98
angolare / corner	100
<b>EASY FLEX</b>	<b>104</b>
angolare / corne	105
centro parete / center wall	106
<b>FS40</b>	<b>110</b>
semi-circolare rettangolare / semi-circular rectangular	111
semi-circolare / semi-circular	112
<b>ECO LATO</b>	<b>116</b>
angolare / corner	117
centro parete / center wall	120
<b>ECO SEM</b>	<b>124</b>
semi-circolare / semi-circular	125
<b>ECOPSC50</b>	<b>128</b>
nicchia / niche	129
angolare / corner	130
centro parete / center wall	132

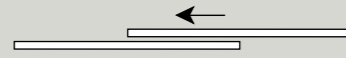

#### porta battente hinge door

<b>SWING CROMO</b>	<b>136</b>
nicchia / niche	137
doppia porta / double door	139
angolare / corner	140
angolare chiusura lato muro / corner wall-side closure	141
<b>SWING NERA</b>	<b>144</b>
doppia porta / double door	145
angolare / corner	147
nicchia / niche	148
<b>SWING ALLUMINIO SPAZZOLATO</b>	<b>152</b>
angolare / corner	153
doppia porta / double door	155
nicchia / niche	156
<b>TEPB43</b>	<b>160</b>
nicchia / niche	161
angolare / corner	162
<b>FPB40</b>	<b>166</b>
angolare / corner	167
nicchia / niche	170
centro parete / center wall	174
<b>TPB72</b>	<b>180</b>
angolare / corner	181
nicchia / niche	182
<b>TVB61</b>	<b>186</b>
semi-circolare / semi-circular	187

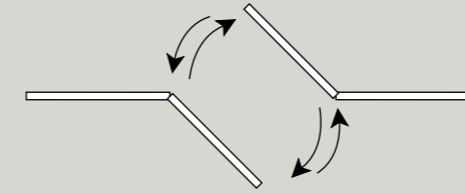

#### porta a saloon saloon door

<b>FPSL60</b>	<b>192</b>
centro parete / center wall	193
angolare / corner	194
nicchia / niche	196
<b>NSALOON S/PROFILI</b>	<b>200</b>
nicchia / niche	201
centro parete / center wall	202
angolare / corner	204

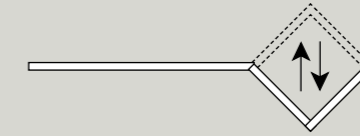

#### porta a soffietto folding door

<b>FPS30</b>	<b>208</b>
angolare / corner	209
centro parete / center wall	210
nicchia / niche	211
<b>TPS35</b>	<b>216</b>
doppia porta / double door	217
nicchia / niche	220
angolare / corner	224



#### soluzioni aperte open solutions

<b>PARETE CROMO WALK-IN</b>	<b>228</b>
<b>PARETE NERA WALK-IN</b>	<b>236</b>
<b>PARETE ALLUMINIO SPAZZOLATO WALK-IN</b>	<b>244</b>

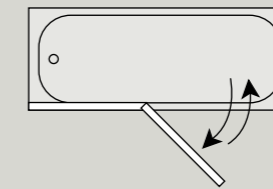

#### sopra vasca bathtub shower panel

<b>TSV50</b>	<b>252</b>
<b>TSV51</b>	<b>256</b>
<b>TSV52</b>	<b>260</b>
<b>TSV53</b>	<b>264</b>

# rapid/quick/easy

Rapid/Quick/Easy è l'innovativo sistema di montaggio rapido sviluppato dal nostro ufficio tecnico, che permette una semplice ed intuitiva installazione del box doccia tramite pochi e semplici step. In questo modo chiunque, anche l'utente finale, è in grado di montare i box doccia Rapid/Quick/Easy.

Rapid/Quick/Easy is the innovative quick assembly system developed by our technical office, which allows a simple and intuitive installation of the shower stall through few simple steps. In this way anyone, even the end user, is able to install the Rapid/Quick/Easy shower stalls.



## \_1 montanti pillars

Unire i due montanti tramite l'apposito incastro.

Join the two pillars using the appropriate joint.



## \_2 spinetta adjusting pin

Inserire la spinetta fornita cosicché i due montanti precedentemente montati siano fissati in maniera solida.

Insert the adjusting pin provided so that the two previously installed pillars are firmly fixed.

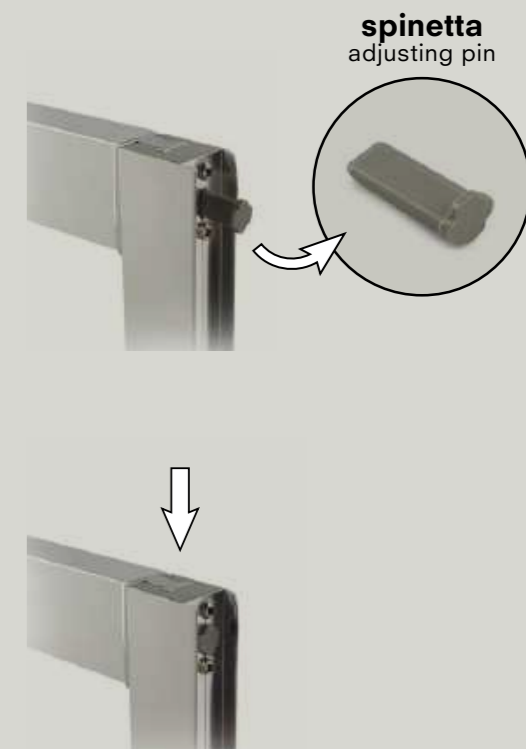

## \_3 profilo profile

Inserire la struttura così montata nell'apposito profilo di fissaggio a muro.

Insert the mounted structure in the appropriate wall fixing profile



## \_4 angolo corner

Per i modelli Angolo e Centro Parete, proseguire montando l'angolo nell'apposito montante fino al "click".

For the Corner and Center Wall models, continue by installing the corner in the appropriate pillar until "click".

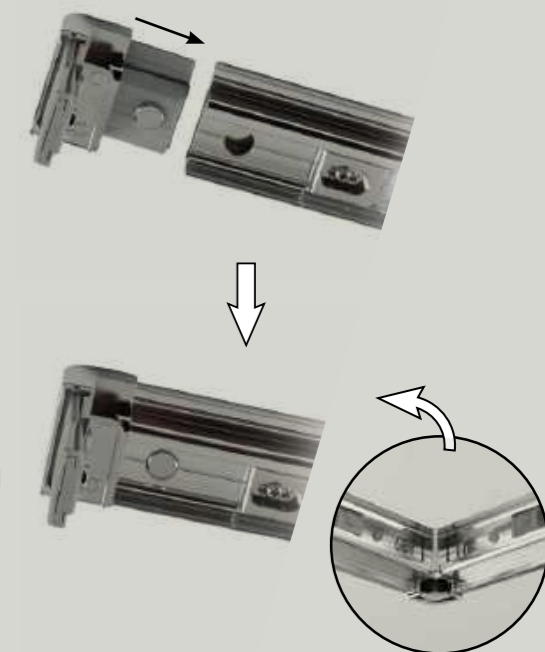

# RAPID

RAPID è un box doccia ad ante scorrevoli, un sistema semplice ma ricco di tecnologia ed esperienza, grazie soprattutto all'innovativo sistema di installazione rapida.

RAPID is a shower stall with sliding doors, a simple system but rich in technology and experience, thanks above all to the innovative quick installation system.

## versioni\_versions

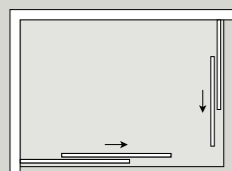

Porta scorrevole  
Versione: Angolo

Sliding door  
Version: Corner

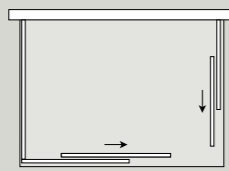

Porta scorrevole  
Versione: Centro parete

Sliding door  
Version: Center wall

## caratteristiche tecniche\_technical characteristics



easy clean

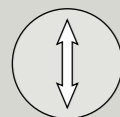

**h 2000 mm**  
altezza  
height

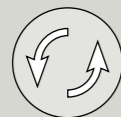

reversibile  
reversible

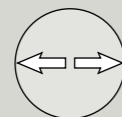

**25 mm**  
regolazione  
adjustment



**6 mm**  
cristallo temperato  
tempered glass

TPAEF11NE



**+30 mm**  
profilo di allungamento  
adjustable profile



sgancio rapido  
quick release

## finiture\_finishes



nero matt  
black matt

## cristallo\_glass



Cristallo trasparente  
Transparent glass



RAPID  
angolo\_corner



Angelica  
colonna doccia  
shower column

Flat bordo  
piatto doccia Bianco  
White shower tray





RAPID + FISSONE  
centro parete\_center wall



Tritone  
colonna doccia  
shower column

Flat bordo  
piatto doccia Bianco  
White shower tray



box doccia 6 mm



# RAPID

Singolo lato per box doccia scorrevole apertura ad angolo\_Single sliding panel corner opening for shower box **H 2000 mm**

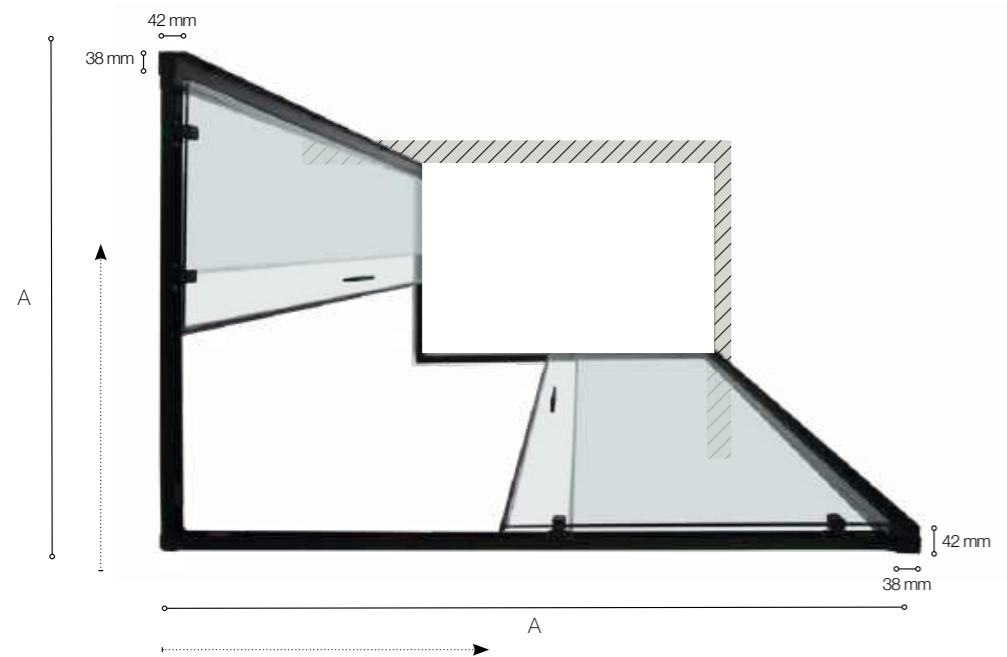

Versione angolare DX  
Right corner version

**APERTURA PORTA**  
OPENING DOOR

RAPID MM	700	750	800	900	1000	1200	1400
700	344	362	380	423	465	554	646
750	362	380	398	437	478	565	655
800	380	398	415	453	492	577	665
900	423	437	453	485	523	603	688
1000	465	478	492	523	556	630	714
1200	554	565	577	603	630	698	773
1400	646	655	665	688	714	773	839

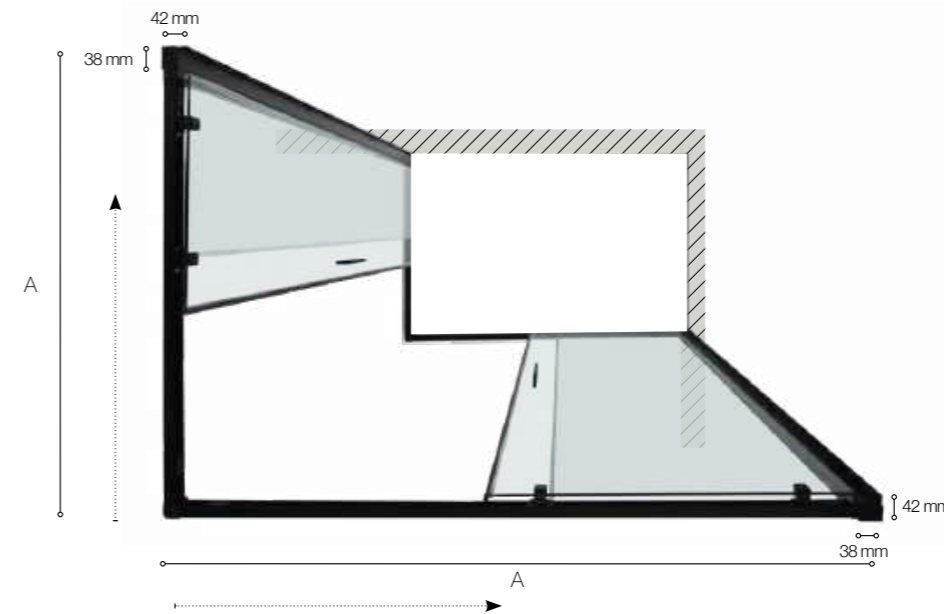

Versione angolare DX  
Right corner version

**SINGOLO LATO PER BOX DOCCIA SCORREVOLE (SOMMARE DUE LATI)**  
SINGLE SLIDING PANEL FOR SHOWER BOX (COMBINE TWO SIDES)

Specifiche tecniche / Technical specifications			
P/D mm	H/H mm	Peso vetro kg / Glass weight kgs	Estensibilità mm / Extension mm
700	2000	24	665 - 690
750	2000	25	715 - 740
800	2000	26	765 - 790
900	2000	29	865 - 890

Specifiche tecniche / Technical specifications			
P/D mm	H/H mm	Peso vetro kg / Glass weight kgs	Estensibilità mm / Extension mm
1000	2000	32	965 - 990
1200	2000	38	1165 - 1190
1400	2000	45	1365 - 1390

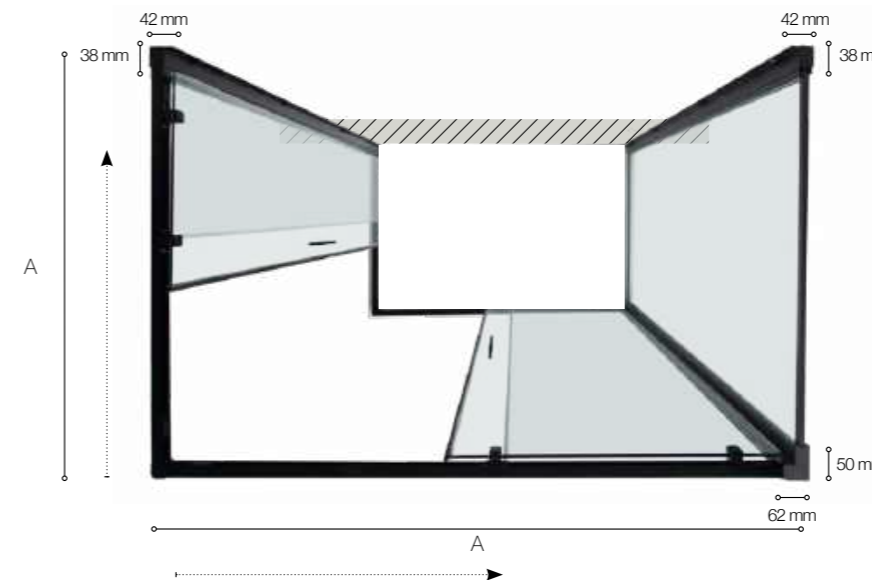

Versione centro parete  
Center wall version

**BOX DOCCIA SCORREVOLE CENTRO PARETE (SOMMARE DUE LATI + LATO FISSO)**  
SHOWER BOX CENTER WALL (COMBINE TWO SIDES + FIXED PANEL)

Specifiche tecniche / Technical specifications			
P/D mm	H/H mm	Peso vetro kg / Glass weight kgs	Estensibilità mm / Extension mm
700	2000	24	677 - 702
750	2000	25	727 - 752
800	2000	26	777 - 802
900	2000	29	877 - 902
1000	2000	32	977 - 1062
1200	2000	38	1177 - 1202
1400	2000	45	1377 - 1402

**DIMENSIONI LATO FISSO (B)**  
FIXED SIDE PANEL SIZE (B)

Specifiche tecniche / Technical specifications			
P/D mm	H/H mm	Peso vetro kg / Glass weight kgs	Estensibilità mm / Extension mm
700	2000	24	665 - 690
800	2000	27	765 - 790
900	2000	30	865 - 890

# PSCRAPID

PSCRAPID è una cabina doccia con anta scorrevoli H 2000 mm. La struttura con profili neri delinea gli spazi in maniera caratterizzante, esaltando così la leggerezza e la trasparenza del vetro.

PSCRAPID is a H 2000 mm shower cubicle with sliding doors. The structure with black profiles strongly outlines spaces, highlighting the glass lightness and transparency.

## versioni\_versions

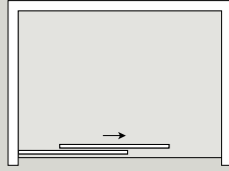

Porta scorrevole  
Versione: Nicchia

Sliding door  
Version: Niche

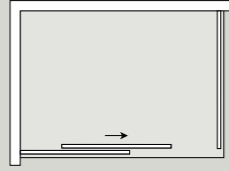

Porta scorrevole  
Versione: Angolo

Sliding door  
Version: Corner

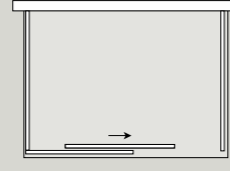

Porta scorrevole  
Versione: Centro parete

Sliding door  
Version: Center wall

## caratteristiche tecniche\_technical characteristics



easy clean

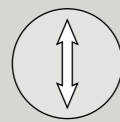

**h 2000 mm**  
altezza  
height

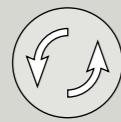

reversibile  
reversible

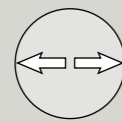

**50 mm**  
regolazione  
adjustment

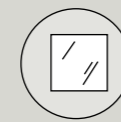

**6 mm**  
cristallo temperato  
tempered glass

**TPAEF11NE**



**+30 mm**  
profilo di allungamento  
adjustable profile



sgancio rapido  
quick release

## finiture\_finishes



nero matt  
black matt

## cristallo\_glass



Cristallo trasparente  
Transparent glass

box doccia 6 mm / box doccia 6 mm

\_67



box doccia 6 mm

## PSCRAPID + FISSONE angolo\_corner



**Sirena**  
colonna doccia  
shower column

**Flat**  
piatto doccia Bianco  
White shower tray



Disponibile per installazioni ad angolo, centro parete e a nicchia, con lo spessore del vetro di 6 mm.

The 6 mm shower enclosure can be installed in a corner, center wall or niche.



box doccia 6 mm

**PSCRAPID + FISSONE**  
centro parete\_center wall

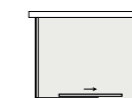

**Angelica**  
colonna doccia  
shower column

**Flat**  
piatto doccia Bianco  
White shower tray



PSCRAPID  
nicchia\_niche



Angelica  
colonna doccia  
shower column

Flat  
piatto doccia Bianco  
White shower tray

# PSCRAPID

Porta scorrevole\_Sliding door **H 2000 mm**

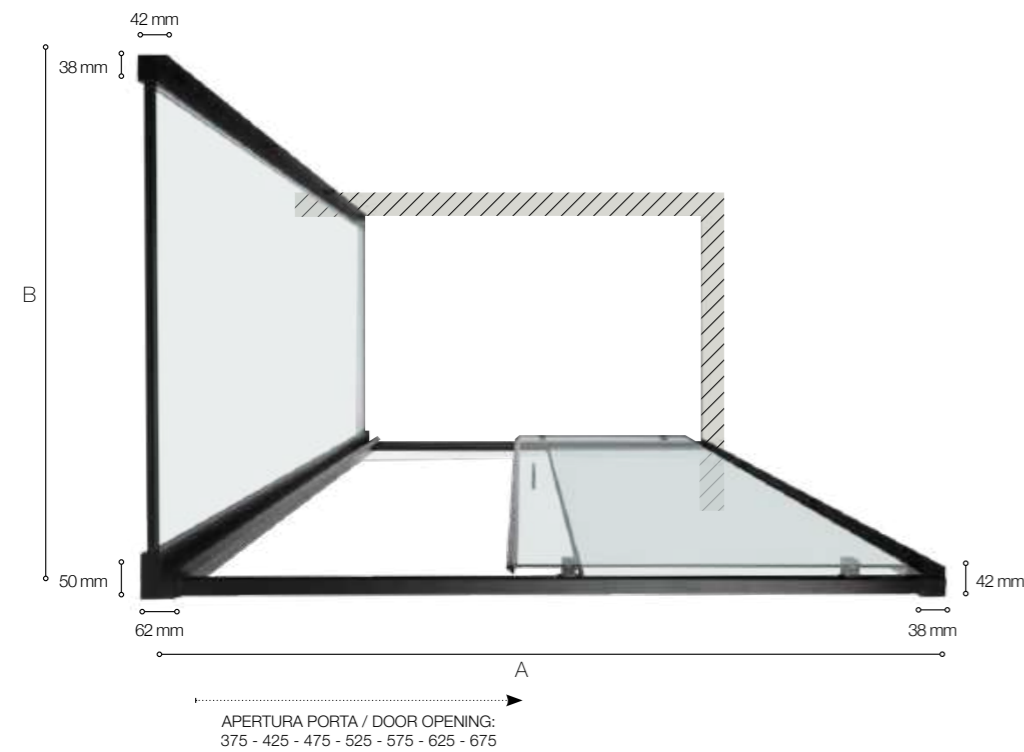

## PORTA ABBINATA A LATO FISSO

DOOR MATCHED WITH FIXED PANEL

Specifiche tecniche / Technical specifications			
P/D	H/H	Peso vetro kg	Estensibilità mm
mm	mm	Glass weight kgs	Extension mm
1000	2000	35	962 - 1010
1100	2000	38	1062 - 1110
1200	2000	41	1162 - 1210
1300	2000	44	1262 - 1310
1400	2000	47	1362 - 1410
1500	2000	50	1462 - 1510
1600	2000	53	1562 - 1610
1700	2000	56	1662 - 1710

## DIMENSIONI LATO FISSO (B)

FIXED SIDE PANEL SIZE (B)

Specifiche tecniche / Technical specifications			
P/D	H/H	Peso vetro kg	Estensibilità mm
mm	mm	Glass weight kgs	Extension mm
700	2000	24	665 - 715
800	2000	27	765 - 815
900	2000	30	865 - 915

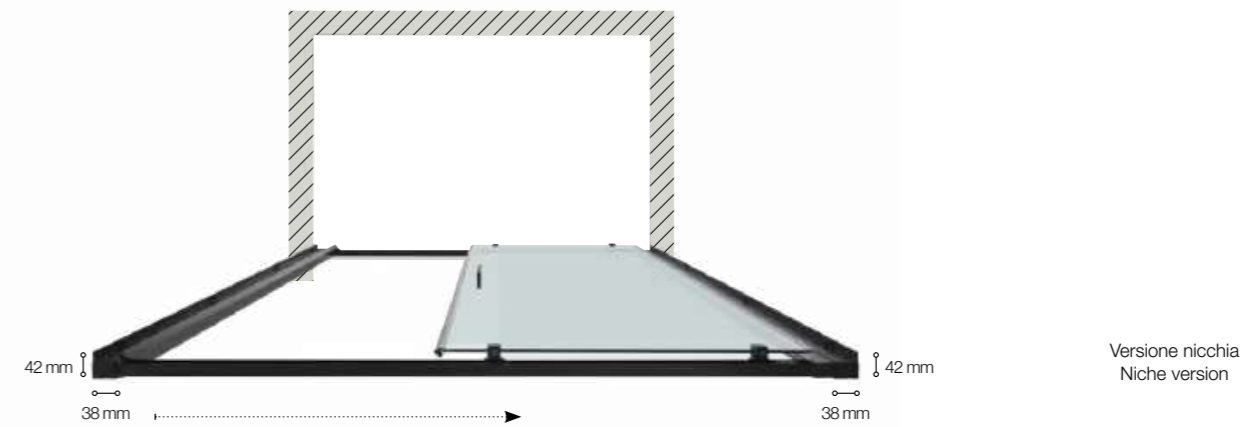

## DIMENSIONI PORTA (A) (NICCHIA)

DOOR SIZES (A) (NICHE)

Specifiche tecniche / Technical specifications				
L/W	H/H	Peso vetro kg	Apertura porta	Estensibilità mm
mm	mm	Glass weight kgs	Door opening	Extension mm
1000	2000	35	375	950 - 1000
1100	2000	38	425	1050 - 1100
1200	2000	41	475	1150 - 1200
1300	2000	44	525	1250 - 1300

Specifiche tecniche / Technical specifications				
L/W	H/H	Peso vetro kg	Apertura porta	Estensibilità mm
mm	mm	Glass weight kgs	Door opening	Extension mm
1400	2000	47	575	1350 - 1400
1500	2000	50	625	1450 - 1500
1600	2000	53	675	1550 - 1600
1700	2000	56	675	1650 - 1700

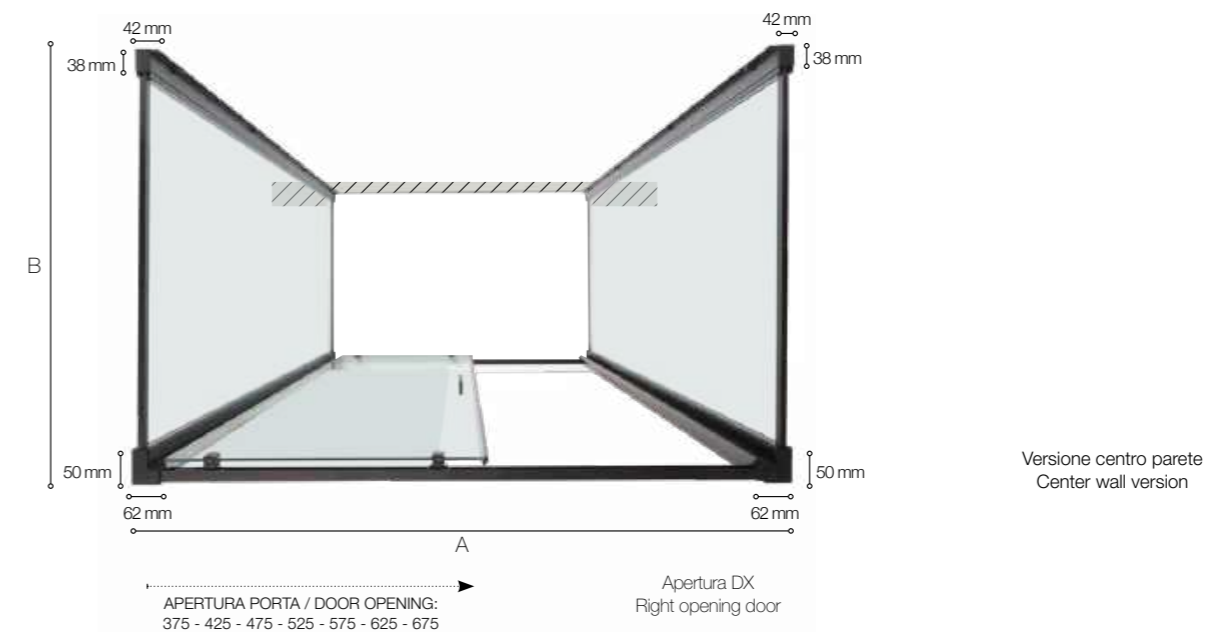

## PORTA ABBINATA A 2 LATI FISSI

DOOR MATCHED WITH 2 FIXED PANELS

Specifiche tecniche / Technical specifications		
P/D	H/H	Estensibilità mm
mm	mm	Extension mm
1000	2000	974 - 1020
1100	2000	1074 - 1120
1200	2000	1174 - 1220
1300	2000	1274 - 1320
1400	2000	1374 - 1420
1500	2000	1474 - 1520
1600	2000	1574 - 1620
1700	2000	1674 - 1720

## DIMENSIONI LATO FISSO (B)

FIXED SIDE PANEL SIZE (B)

Specifiche tecniche / Technical specifications			
P/D	H/H	Peso vetro kg	Estensibilità mm
mm	mm	Glass weight kgs	Extension mm
700	2000	24	665 - 715
800	2000	27	765 - 815
900	2000	30	865 - 915

# QUICK

QUICK è una serie di box doccia ad installazione rapida, perfetto per chi ama soluzioni semplici ed intuitive coniugate ad un design essenziale ed elegante, in grado di inserirsi in molteplici ambienti bagno.

QUICK is a series of quick assembly shower stalls, perfect for those who look for simple and intuitive solutions combined with essential and elegant design, able to fit into different bathroom styles.

## versioni\_versions

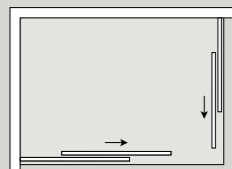

Porta scorrevole  
Versione: Angolo

Sliding door  
Version: Corner

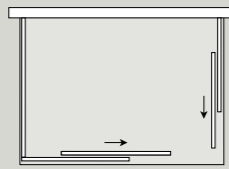

Porta scorrevole  
Versione: Centro parete

Sliding door  
Version: Center wall

## caratteristiche tecniche\_technical characteristics



easy clean

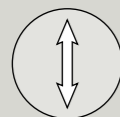

**h 2000 mm**  
altezza  
height

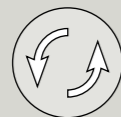

reversibile  
reversible

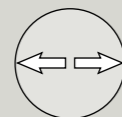

**25 mm**  
regolazione  
adjustment



**6 mm**  
cristallo temperato  
tempered glass



**TPAEF11**  
**+30 mm**  
profilo di allungamento  
adjustable profile



sgancio rapido  
quick release

## finiture\_finishes



cromo  
chrome

## cristallo\_glass



Cristallo trasparente  
Transparent glass



QUICK  
angolo\_corner



**Nettuno**  
colonna doccia  
shower column

**Flat**  
piatto doccia Bianco  
White shower tray



**QUICK + FISSO**  
centro parete\_center wall



**Diana**  
colonna doccia  
shower column

**Flat**  
piatto doccia Bianco  
White shower tray



box doccia 6 mm

Dalla struttura solida e curata nei dettagli, la serie QUICK si configura come la più intuitiva grazie alle cerniere per lo sgancio rapido che garantiscono oltre alla rapidità di installazione, anche maggior facilità di pulizia e igiene dello spazio doccia e delle guide di scorrimento.

With its solid and well-finished structure, the QUICK series presents itself as the most intuitive, thanks to the quick-release hinges which guarantee a fast installation and an easier cleaning of the shower stall and its sliding guides.





# QUICK

Singolo lato per box doccia scorrevole, apertura ad angolo\_Single sliding panel for shower box, corner opening **H 2000 mm**

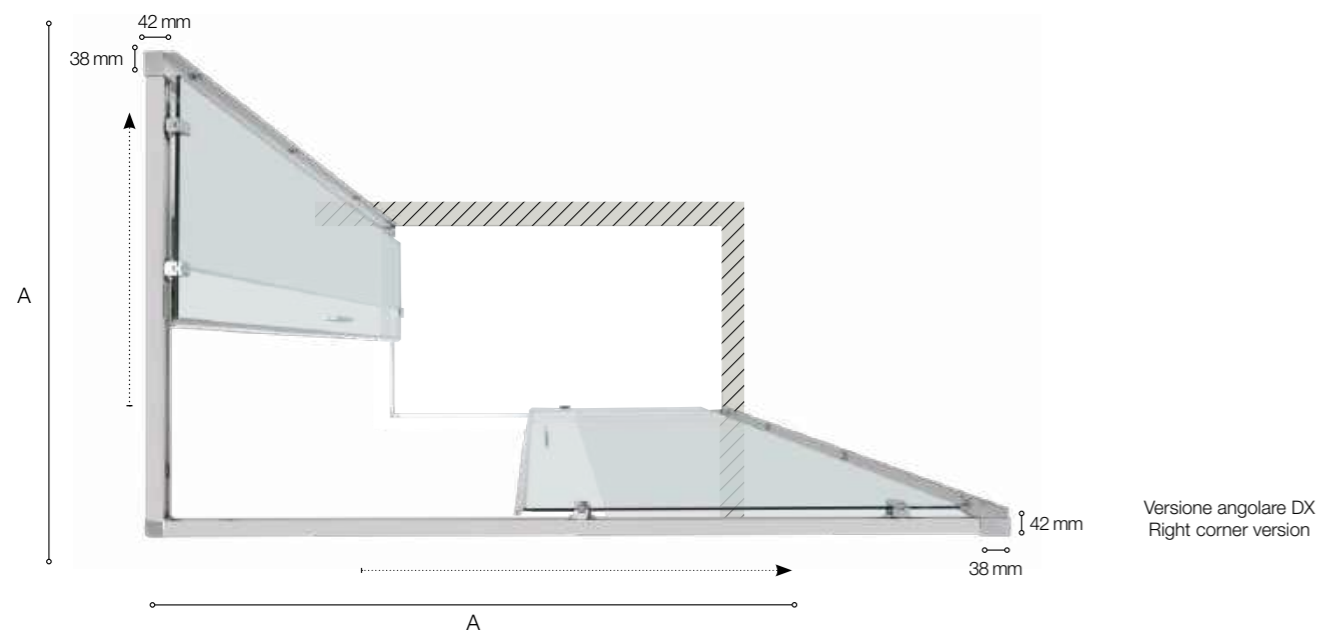

## APERTURA PORTA OPENING DOOR

QUICK MM	700	720	750	800	850	900	1000	1200	1400
700	344	350	362	380	390	423	465	554	646
720	350	359	370	389	396	428	570	558	649
750	362	370	380	398	405	437	478	565	655
800	380	389	398	415	422	453	492	577	665
850	390	396	405	422	440	458	495	576	663
900	423	428	437	453	458	485	523	603	688
1000	465	470	478	492	495	523	556	630	714
1200	554	558	565	577	576	603	630	698	773
1400	646	649	655	665	663	688	714	773	839

## box doccia 6 mm / 6 mm shower box

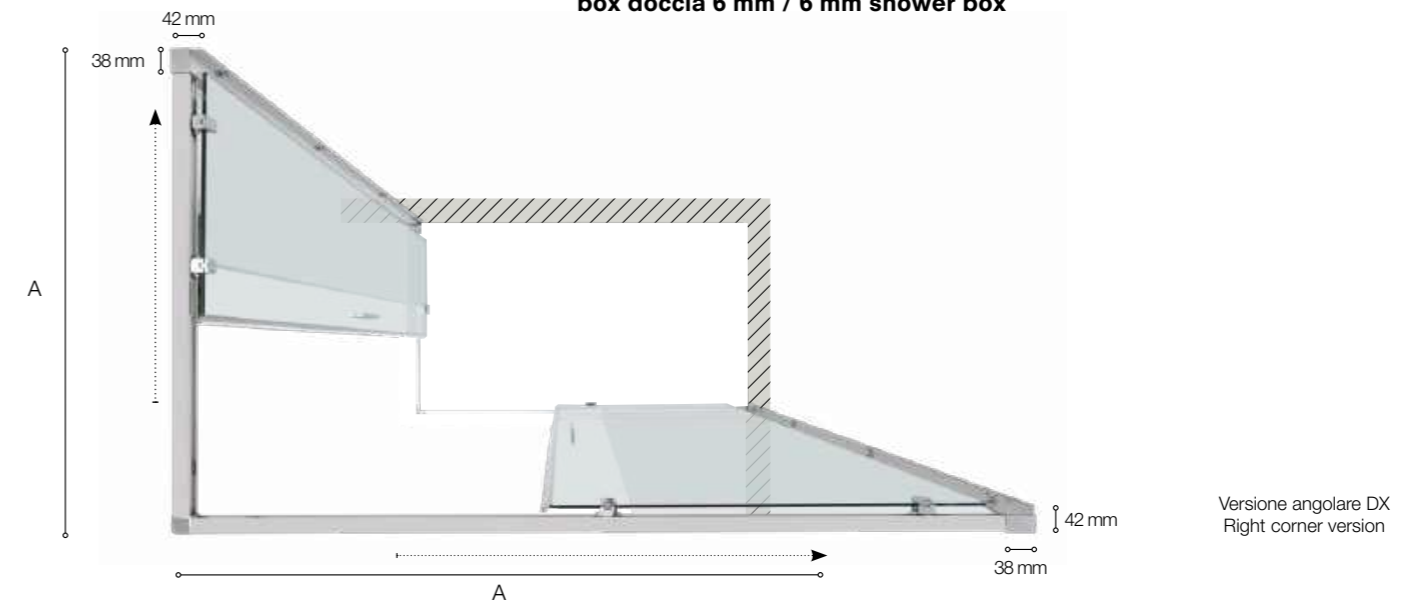

## SINGOLO LATO PER BOX DOCCIA SCORREVOLE (SOMMARE DUE LATI) SINGLE SLIDING PANEL FOR SHOWER BOX (COMBINE TWO SIDES)

Specifiche tecniche / Technical specifications			
P/D	H/H	Peso vetro kg	Estensibilità mm
mm	mm	Glass weight kgs	Extension mm
700	2000	23	665 - 690
720	2000	24	685 - 710
750	2000	26	715 - 740
800	2000	27	765 - 790
850	2000	28	815 - 840

Specifiche tecniche / Technical specifications			
P/D	H/H	Peso vetro kg	Estensibilità mm
mm	mm	Glass weight kgs	Extension mm
900	2000	29	865 - 890
1000	2000	35	965 - 990
1200	2000	38	1165 - 1190
1400	2000	45	1365 - 1390

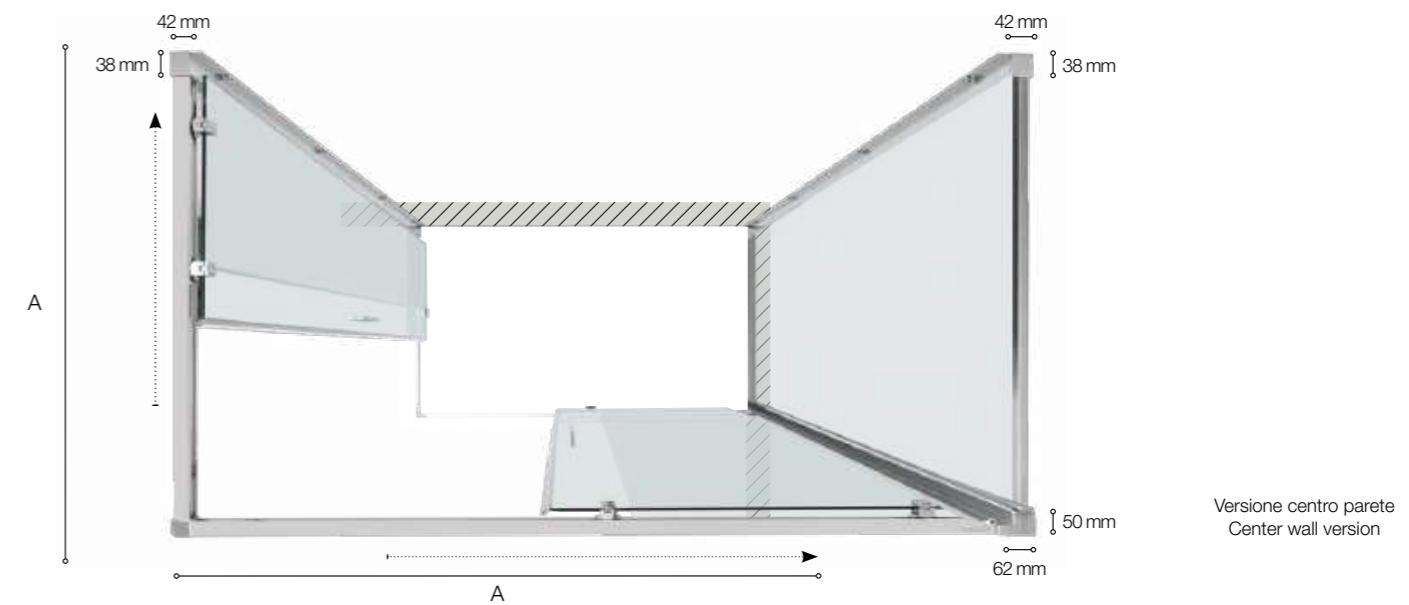

## BOX DOCCIA SCORREVOLE CENTRO PARETE (SOMMARE DUE LATI + LATO FISSO) SHOWER BOX CENTER WALL (COMBINE TWO SIDES + FIXED PANEL)

Specifiche tecniche / Technical specifications			
P/D	H/H	Peso vetro kg	Estensibilità mm
mm	mm	Glass weight kgs	Extension mm
700	2000	23	677 - 702
720	2000	24	697 - 722
750	2000	26	727 - 752
800	2000	27	777 - 802
850	2000	28	827 - 852
900	2000	29	877 - 902
1000	2000	35	977 - 1002
1200	2000	38	1177 - 1202
1400	2000	45	1377 - 1402

## DIMENSIONI LATO FISSO (B) FIXED SIDE PANEL SIZE (B)

Specifiche tecniche / Technical specifications			
P/D	H/H	Peso vetro kg	Estensibilità mm
mm	mm	Glass weight kgs	Extension mm
700	2000	24	665 - 690
800	2000	27	765 - 790
900	2000	30	865 - 890
1000	2000	34	965 - 990

# PSCQUICK

PSCQUICK è un box doccia ad ante scorrevoli, caratterizzato dall'innovativo sistema ad installazione rapida. La struttura cromata e i dettagli minimali lo rendono adatto ad ambienti moderni.

PSCQUICK is a shower stall with sliding doors, characterized by the innovative quick assembly system. The chromed structure and the minimal details make it suitable for modern interiors.

## versioni\_versions

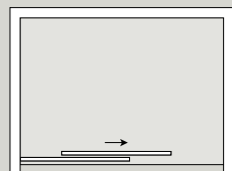

Porta scorrevole  
Versione: Nicchia  
Sliding door  
Version: Niche

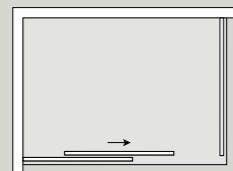

Porta scorrevole  
Versione: Angolo  
Sliding door  
Version: Corner

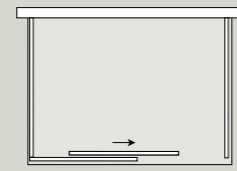

Porta scorrevole  
Versione: Centro parete  
Sliding door  
Version: Center wall

## caratteristiche tecniche\_technical characteristics



easy clean

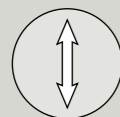

**h 2000 mm**  
altezza  
height

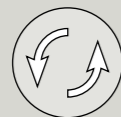

reversibile  
reversible

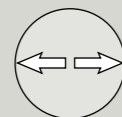

**50 mm**  
regolazione  
adjustment

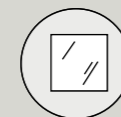

**6 mm**  
cristallo temperato  
tempered glass

TPAEF11



**+30 mm**  
profilo di allungamento  
adjustable profile



sgancio rapido  
quick release

## finiture\_finishes



cromo  
chrome

## cristallo\_glass



Cristallo trasparente  
Transparent glass



PSCQUICK + FISSO  
centro parete\_center wall



**Diana**  
colonna doccia  
shower column

**Flat**  
piatto doccia Bianco  
White shower tray



PSCQUICK + FISSO  
angolo\_corner



Sirena  
colonna doccia  
shower column

La semplicità dell'installazione si coniuga ad un elevato standard qualitativo. Perfetta tenuta all'acqua e stabilità, garantite dai dettagli tecnici e dai sistemi di chiusura e delle giunture perfettamente aderenti.

The simplicity of the installation combined with high quality standards. Perfect waterproofness and stability, ensured by the technical details, the closing systems and the perfectly close-fitting joints.





PSCQUICK si inserisce nell'ambiente bagno con raffinatezza ed eleganza, grazie ai dettagli cromati dalle forme squadrate ed essenziali, sia nella versione nicchia che nelle versioni angolo e centro parete.

PSCQUICK fits into the bathroom with refinement and elegance, thanks to the chromed details with square and essential shapes, both in the niche version and in the corner and center wall versions.



**PSCQUICK**  
nicchia\_niche

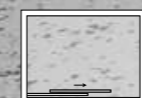

**Nettuno**  
colonna doccia  
shower column

# PSCQUICK

Porta scorrevole\_Sliding door **H 2000 mm**

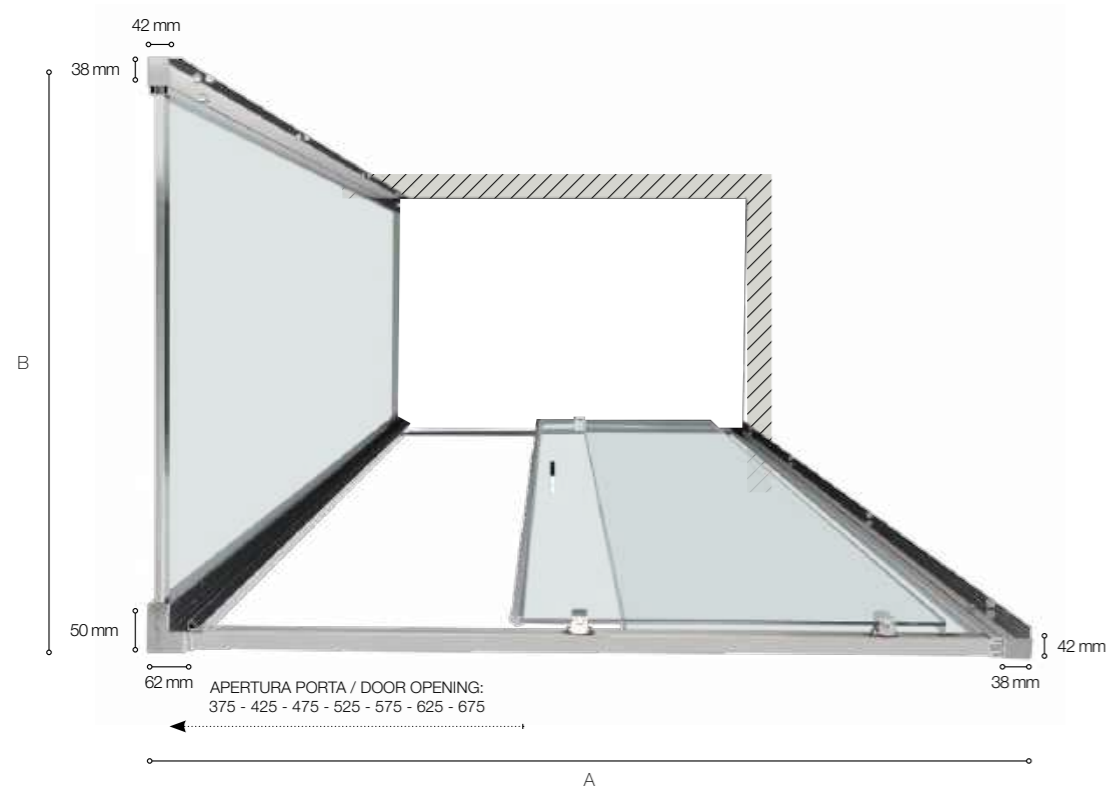

Versione Angolare DX  
Right Corner Version

## PORTA ABBINATA A LATO FISSO DOOR MATCHED WITH FIXED PANEL

Specifiche tecniche / Technical specifications		
P/D	H/H	Estensibilità mm
mm	mm	Extension mm
1000	2000	962 - 1010
1100	2000	1062 - 1110
1200	2000	1162 - 1210
1300	2000	1262 - 1310
1400	2000	1362 - 1410
1500	2000	1462 - 1510
1600	2000	1562 - 1610
1700	2000	1662 - 1710
1800	2000	1762 - 1810

## DIMENSIONI LATO FISSO (B) FIXED SIDE PANEL SIZE (B)

Specifiche tecniche / Technical specifications			
P/D	H/H	Peso vetro kg	Estensibilità mm
mm	mm	Glass weight kgs	Extension mm
650	2000	22	615 - 665
700	2000	24	665 - 715
800	2000	27	765 - 815
900	2000	30	865 - 915
1000	2000	34	965 - 1015

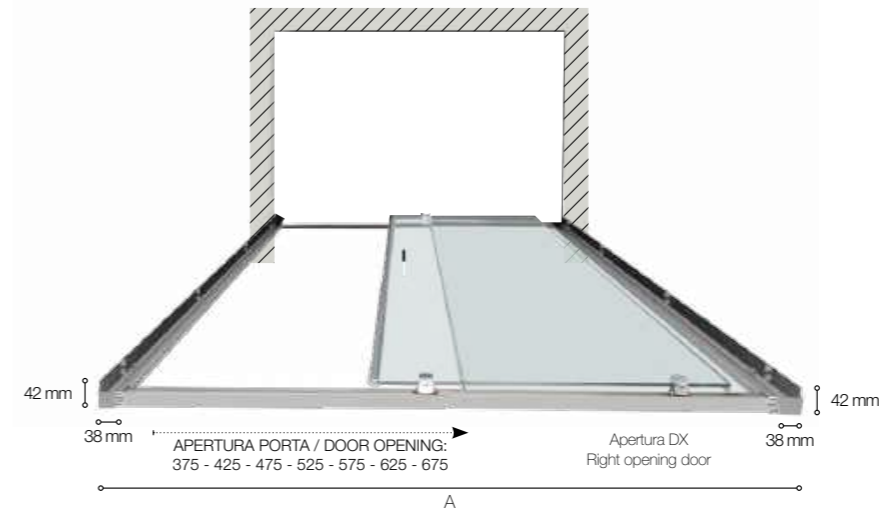

Versione nicchia  
Niche version

## DIMENSIONI PORTA (A) (NICCHIA) DOOR SIZES (A) (NICHE)

Specifiche tecniche / Technical specifications				
L/W	H/H	Peso vetro kg	Apertura porta	Estensibilità mm
mm	mm	Glass weight kgs	Door opening	Extension mm
1000	2000	34	375	950 - 1000
1100	2000	39	425	1050 - 1100
1200	2000	42	475	1150 - 1200
1300	2000	45	525	1250 - 1300
1400	2000	48	575	1350 - 1400

Specifiche tecniche / Technical specifications				
L/W	H/H	Peso vetro kg	Apertura porta	Estensibilità mm
mm	mm	Glass weight kgs	Door opening	Extension mm
1500	2000	51	625	1450 - 1500
1600	2000	54	675	1550 - 1600
1700	2000	57	675	1650 - 1700
1800	2000	59	675	1750 - 1800

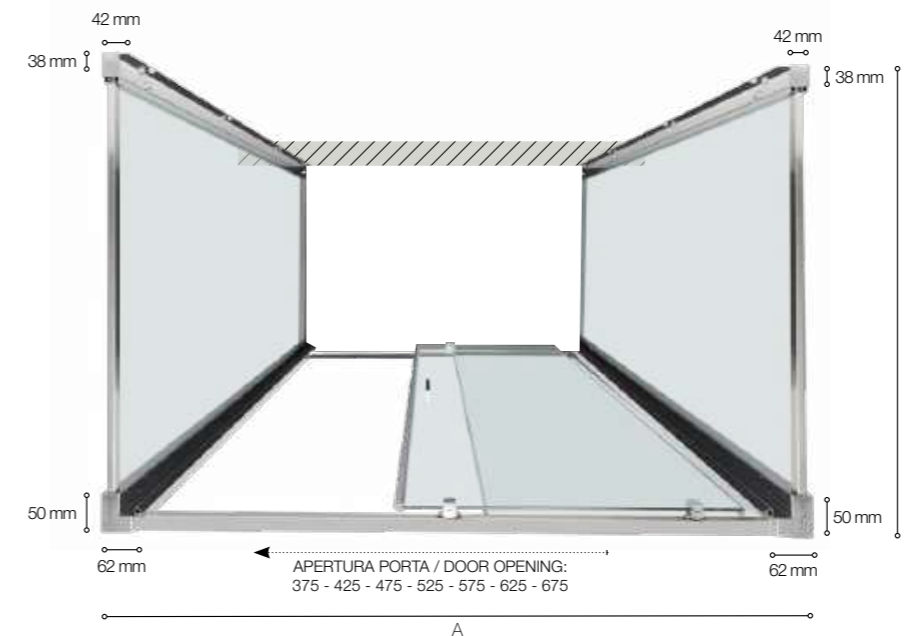

Versione Centro Parete  
Center Wall Version

## PORTA ABBINATA A 2 LATI FISSI DOOR MATCHED WITH 2 FIXED PANELS

Specifiche tecniche / Technical specifications		
P/D	H/H	Estensibilità mm
mm	mm	Extension mm
1000	2000	974 - 1020
1100	2000	1074 - 1120
1200	2000	1174 - 1220
1300	2000	1274 - 1320
1400	2000	1374 - 1420
1500	2000	1474 - 1520
1600	2000	1574 - 1620
1700	2000	1674 - 1720
1800	2000	1774 - 1820

## DIMENSIONI LATO FISSO (B) FIXED SIDE PANEL SIZE (B)

Specifiche tecniche / Technical specifications			
P/D	H/H	Peso vetro kg	Estensibilità mm
mm	mm	Glass weight kgs	Extension mm
650	2000	22	615 - 665
700	2000	24	665 - 715
800	2000	27	765 - 815
900	2000	30	865 - 915
1000	2000	34	965 - 1015

# EASYPSC50

Grazie al sistema di montaggio Easy, la cabina doccia EASYPSC50 consente un'installazione rapida e semplice, alla portata di tutti.

Thanks to the Easy mounting system, the EASYPSC50 shower cabin allows for a quick and simple installation, accessible to everyone.

## versioni\_versions

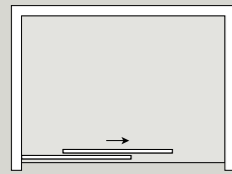

Porta scorrevole  
Versione: Nicchia

Sliding door  
Version: Niche

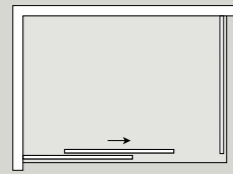

Porta scorrevole  
Versione: Angolo

Sliding door  
Version: Corner

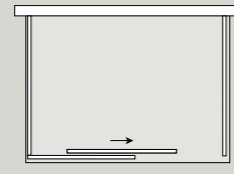

Porta scorrevole  
Versione: Centro parete

Sliding door  
Version: Center wall

## caratteristiche tecniche\_technical characteristics



easy clean

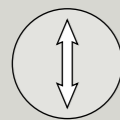

**h 2000 mm**  
altezza  
height

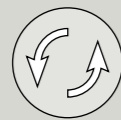

reversibile  
reversible

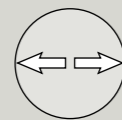

**50 mm**  
regolazione  
adjustment

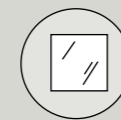

**6 mm**  
cristallo temperato  
tempered glass



**TPAEF11**  
**+30 mm**  
profilo di allungamento  
adjustable profile



sgancio rapido  
quick release

## finiture\_finishes



cromo  
chrome

## cristallo\_glass

Cristallo satinato  
Frosted glass

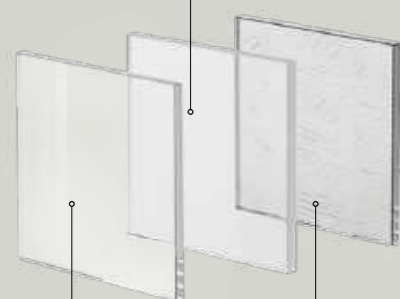

Cristallo trasparente  
Transparent glass

Cristallo Cincillà  
Chinchilla glass



EASYPSC50 + FISSO  
centro parete\_center wall



**Nettuno**  
colonna doccia  
shower column

**Flat**  
piatto doccia Bianco  
White shower tray

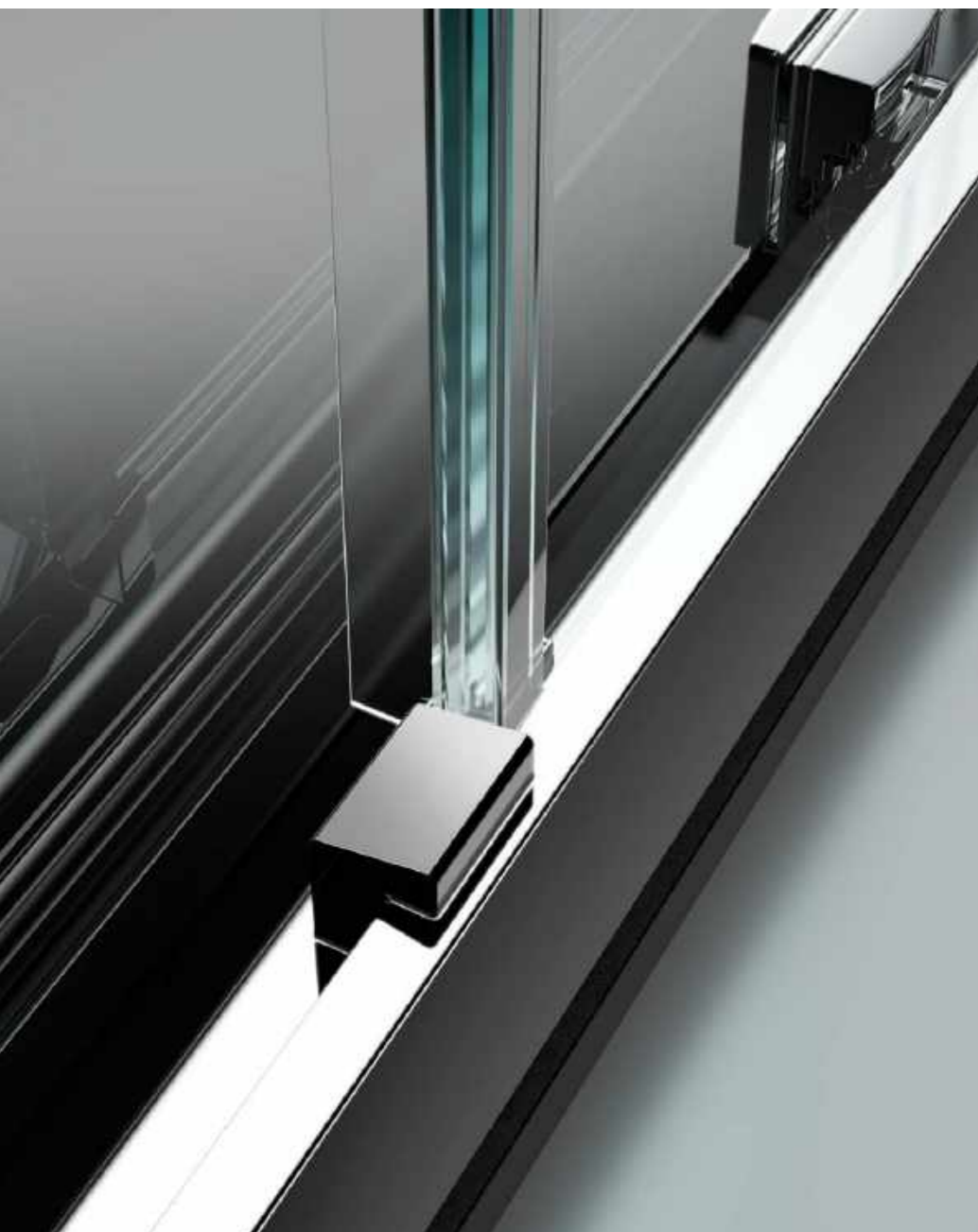

Profilato da un telaio caratterizzante è molto curato nei dettagli strutturali ed estetici.

Rich profiles, which have been manufactured with great care, ensure watertightness and stability.



**EASYPSC50 + FISSO**  
angolo\_corner



**Sirena**  
colonna doccia  
shower column

**Flat**  
piatto doccia Nero  
Black shower tray



I profili montanti sono dotati di tappo anti-polvere e consentono una tolleranza dimensionale da 1 a 5 cm, in modo da potersi adattare su piatti più o meno grandi.

The vertical frame elements have a dust protection cap. Moreover, the vertical profiles have a tolerance of 1 to 5 cm as to permit the installation on different size shower trays.



**EASYPSC50**  
nicchia\_niche



**Flat**  
piatto doccia Grigio cemento  
Concrete grey shower tray



# EASYPSC50

Porta scorrevole\_Sliding door **H 2000 mm**

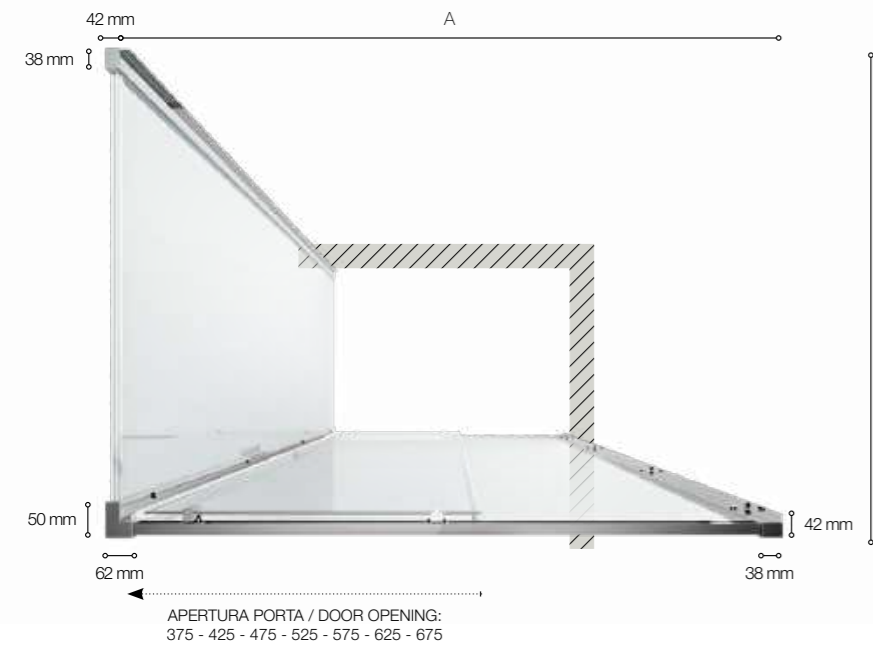

Versione Angolare DX  
Right Corner Version

**PORTA ABBINATA A LATO FISSO**  
DOOR MATCHED WITH FIXED PANEL

Specifiche tecniche / Technical specifications		
P/D mm	H/H mm	Estensibilità mm Extension mm
1000	2000	962 - 1010
1100	2000	1062 - 1110
1200	2000	1162 - 1210
1300	2000	1262 - 1310
1400	2000	1362 - 1410
1500	2000	1462 - 1510
1600	2000	1562 - 1610
1700	2000	1662 - 1710
1800	2000	1762 - 1810

**DIMENSIONI LATO FISSO (B)**  
FIXED SIDE PANEL SIZE (B)

Specifiche tecniche / Technical specifications			
P/D mm	H/H mm	Peso vetro kg Glass weight kgs	Estensibilità mm Extension mm
650	2000	22	615 - 665
700	2000	24	665 - 715
800	2000	27	765 - 815
900	2000	30	865 - 915
1000	2000	34	965 - 1015

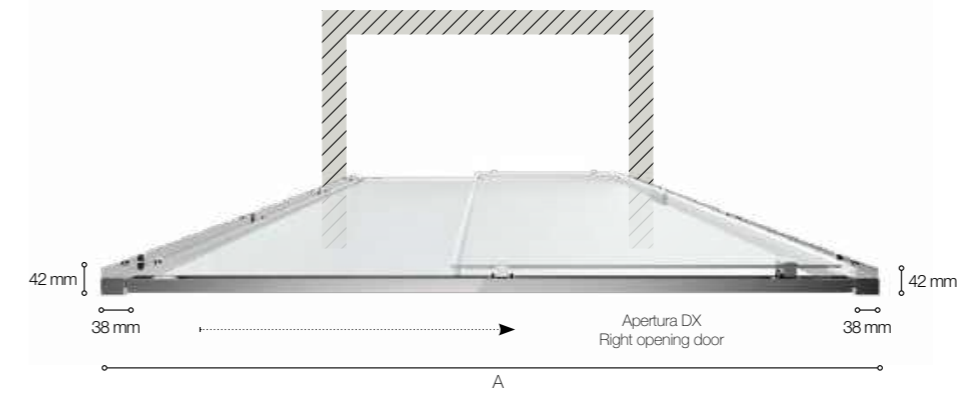

Versione nicchia  
Niche version

**DIMENSIONI PORTA (A) (NICCHIA)**  
DOOR SIZES (A) (NICHE)

Specifiche tecniche / Technical specifications				
L/W mm	H/H mm	Peso vetro kg Glass weight kgs	Apertura porta Door opening	Estensibilità mm Extension mm
1000	2000	35	375	950 - 1000
1100	2000	38	425	1050 - 1100
1200	2000	40	475	1150 - 1200
1300	2000	43	525	1250 - 1300
1400	2000	47	575	1350 - 1400

Specifiche tecniche / Technical specifications				
L/W mm	H/H mm	Peso vetro kg Glass weight kgs	Apertura porta Door opening	Estensibilità mm Extension mm
1500	2000	50	625	1450 - 1500
1600	2000	53	675	1550 - 1600
1700	2000	56	675	1650 - 1700
1800	2000	59	675	1750 - 1800

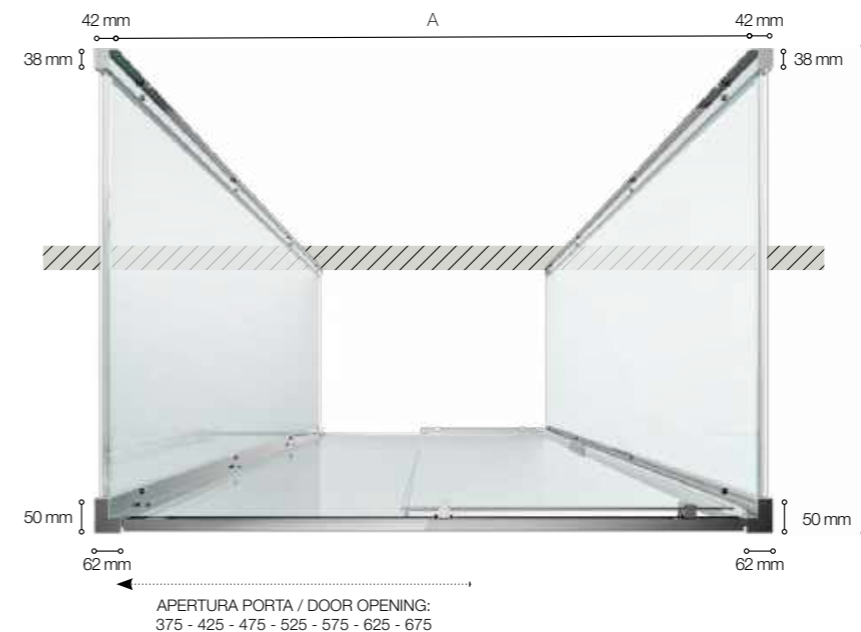

Versione Centro Parete  
Center Wall Version

**PORTA ABBINATA A 2 LATI FISSI**  
DOOR MATCHED WITH 2 FIXED PANELS

Specifiche tecniche / Technical specifications		
P/D mm	H/H mm	Estensibilità mm Extension mm
1000	2000	974 - 1020
1100	2000	1074 - 1120
1200	2000	1174 - 1220
1300	2000	1274 - 1320
1400	2000	1374 - 1420
1500	2000	1474 - 1520
1600	2000	1574 - 1620
1700	2000	1674 - 1720
1800	2000	1774 - 1820

**DIMENSIONI LATO FISSO (B)**  
FIXED SIDE PANEL SIZE (B)

Specifiche tecniche / Technical specifications			
P/D mm	H/H mm	Peso vetro kg Glass weight kgs	Estensibilità mm Extension mm
650	2000	22	615 - 665
700	2000	24	665 - 715
800	2000	27	765 - 815
900	2000	30	865 - 915
1000	2000	34	965 - 1015

# FPSC57

FPSC57 è una cabina doccia a doppia porta scorrevole con le diverse tipologie di installazione centroparete, a nicchia e ad angolo. Prevede l'impiego di vetri laterali fissi e ante scorrevoli per il lato ingresso.

The FPSC57 shower enclosure with double sliding doors can be installed center wall, niche and corner. It includes a glass fixed panel and a sliding door for entrance.

## versioni\_versions

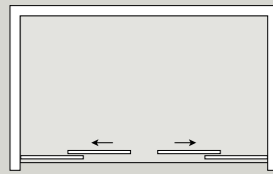

Porta scorrevole  
Versione: Nicchia

Sliding door  
Version: Niche

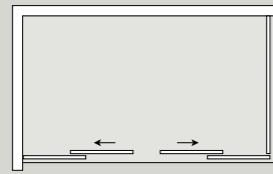

Porta scorrevole  
Versione: Angolo

Sliding door  
Version: Corner

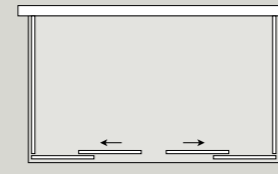

Porta scorrevole  
Versione: Centro parete

Sliding door  
Version: Center wall

## caratteristiche tecniche\_technical characteristics



easy clean

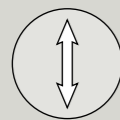

**h 2000 mm**  
altezza  
height

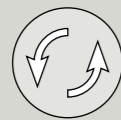

reversibile  
reversible

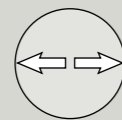

**50 mm**  
regolazione  
adjustment

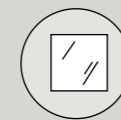

**6 mm**  
cristallo temperato  
tempered glass

TPAEF11



**+30 mm**  
profilo di allungamento  
adjustable profile



sgancio rapido  
quick release

## finiture\_finish



cromo  
chrome

## cristallo\_glass

Cristallo satinato  
Frosted glass

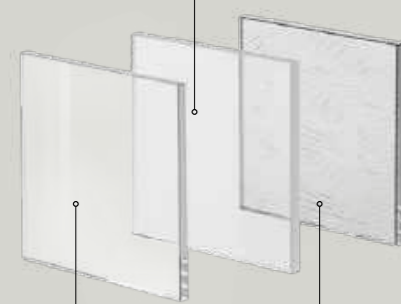

Cristallo trasparente  
Transparent glass

Cristallo Cincillà  
Chinchilla glass



## FPSC57 + FISSO centro parete\_center wall

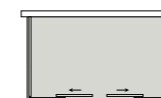

**Diana**  
colonna doccia  
shower column

**Flat**  
piatto doccia Grigio cemento  
Concrete grey shower tray



FPSC57  
nicchia\_niche



**Nettuno**  
colonna doccia  
shower column

**Flat**  
piatto doccia Antracite  
Anthracite shower tray



box doccia 6 mm

Profilata da un telaio solido è molto curata nei dettagli strutturali ed estetici, come le cerniere per lo sgancio rapido, per una garanzia di pulizia e igiene dello spazio doccia e delle guide di scorrimento.

The surrounding frame is solid and well finished, both structurally and aesthetically. The quick release sliding mechanism permits easy cleaning of the doors and sliding mechanisms.



Assicura perfetta tenuta all'acqua e stabilità, grazie a sistemi di fissaggio e chiusura altamente prestazionali.

The profiles ensure both water-tightness and stability, thanks to high-performing fixing and closing systems.



FPSC57 + FISSO  
angolo\_corner



**Danubio**  
colonna doccia  
shower column

**Flat**  
piatto doccia Bianco  
White shower tray

# FPSC57

Doppia porta con apertura scorrevole\_Double sliding door **H 2000 mm**

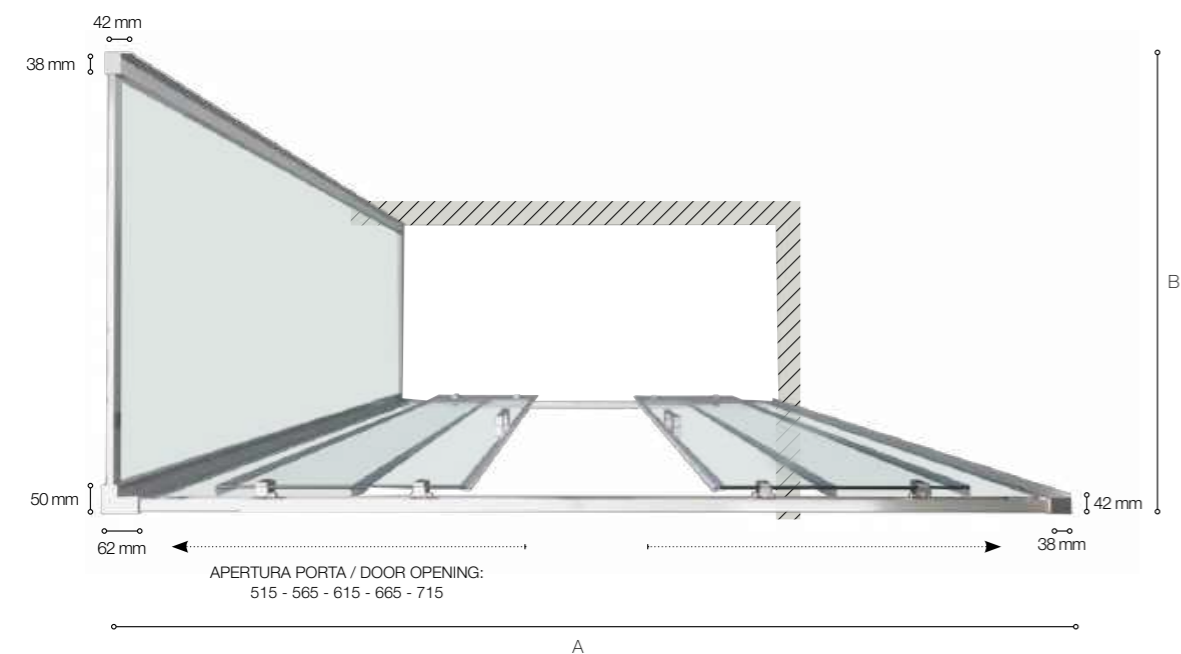

**PORTA ABBINATA A LATO FISSO**  
DOOR MATCHED WITH FIXED PANEL

Specifiche tecniche / Technical specifications		
P/D	H/H	Estensibilità mm
mm	mm	Extension mm
1400	2000	1362 - 1410
1500	2000	1462 - 1510
1600	2000	1562 - 1610
1700	2000	1662 - 1710
1800	2000	1762 - 1810

**DIMENSIONI LATO FISSO (B)**  
FIXED SIDE PANEL SIZE (B)

Specifiche tecniche / Technical specifications			
P/D	H/H	Peso vetro kg	Estensibilità mm
mm	mm	Glass weight kgs	Extension mm
650	2000	22	615 - 665
700	2000	24	665 - 715
800	2000	27	765 - 815
900	2000	30	865 - 915
1000	2000	34	965 - 1015

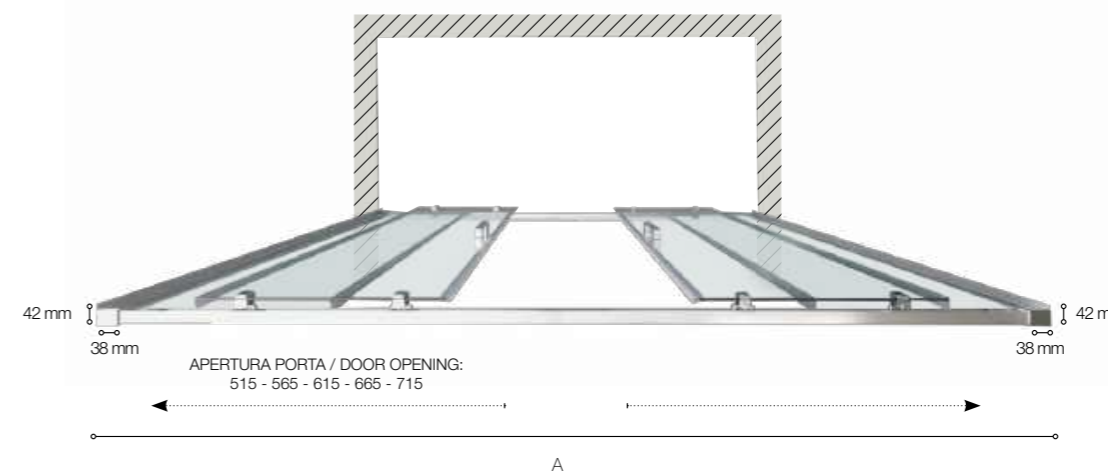

Versione Nicchia  
Niche Version

**DIMENSIONI PORTA (A) (NICCHIA)**  
DOOR SIZES (A) (NICHE)

Specifiche tecniche / Technical specifications				
L/W	H/H	Peso vetro kg	Apertura porta	Estensibilità mm
mm	mm	Glass weight kgs	Door opening	Extension mm
1400	2000	48	515	1350 - 1400
1500	2000	51	565	1450 - 1500
1600	2000	54	615	1550 - 1600
1700	2000	57	665	1650 - 1700
1800	2000	60	715	1750 - 1800



Versione Centro Parete  
Center Wall Version

**PORTA ABBINATA A 2 LATI FISSI**  
DOOR MATCHED WITH 2 FIXED PANELS

Specifiche tecniche / Technical specifications			
P/D	H/H	Estensibilità mm	
mm	mm	Extension mm	
1400	2000	1374 - 1420	
1500	2000	1474 - 1520	
1600	2000	1574 - 1620	
1700	2000	1674 - 1720	
1800	2000	1774 - 1820	

**DIMENSIONI LATO FISSO (B)**  
FIXED SIDE PANEL SIZE (B)

Specifiche tecniche / Technical specifications			
P/D	H/H	Peso vetro kg	Estensibilità mm
mm	mm	Glass weight kgs	Extension mm
650	2000	22	615 - 665
700	2000	24	665 - 715
800	2000	27	765 - 815
900	2000	30	865 - 915
1000	2000	34	965 - 1015

# EASYFLEX

Cabina doccia ad installazione rapida grazie al sistema di montaggio Easy. Si adatta a piatti rettangolari e quadrati, con installazione ad angolo e centro parete.

Quick installation shower enclosure thanks to the Easy mounting system. It accommodates rectangular and square trays, with corner and center wall installation.

## versioni\_versions



Doppia porta scorrevole  
Versione: Angolo

Double sliding door  
Version: Corner



Doppia porta scorrevole  
Versione: Centro parete

Double sliding door  
Version: Center wall

## caratteristiche tecniche\_technical characteristics



easy clean

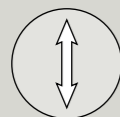

**h 2000 mm**  
altezza  
height



reversibile  
reversible

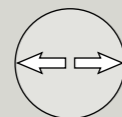

**25 mm**  
regolazione  
adjustment



**6 mm**  
cristallo temperato  
tempered glass



**TPAEF11**  
**+30 mm**  
profilo di allungamento  
adjustable profile



sgancio rapido  
quick release

## finiture\_finishes



cromo  
chrome

## cristallo\_glass

Cristallo satinato  
Frosted glass

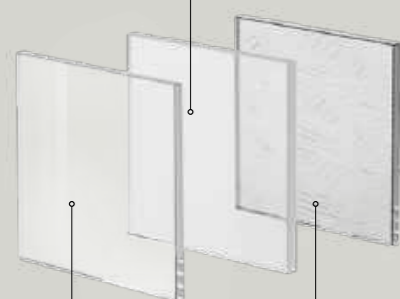

Cristallo trasparente  
Transparent glass

Cristallo Cincillà  
Chinchilla glass



EASYFLEX  
angolo\_corner



**Diana**  
colonna doccia  
shower column

**Flat bordo**  
piatto doccia Bianco  
White shower tray



**EASYFLEX + FISSO**  
centro parete\_center wall



**Diana**  
colonna doccia  
shower column

**Flat**  
piatto doccia Bianco  
White shower tray

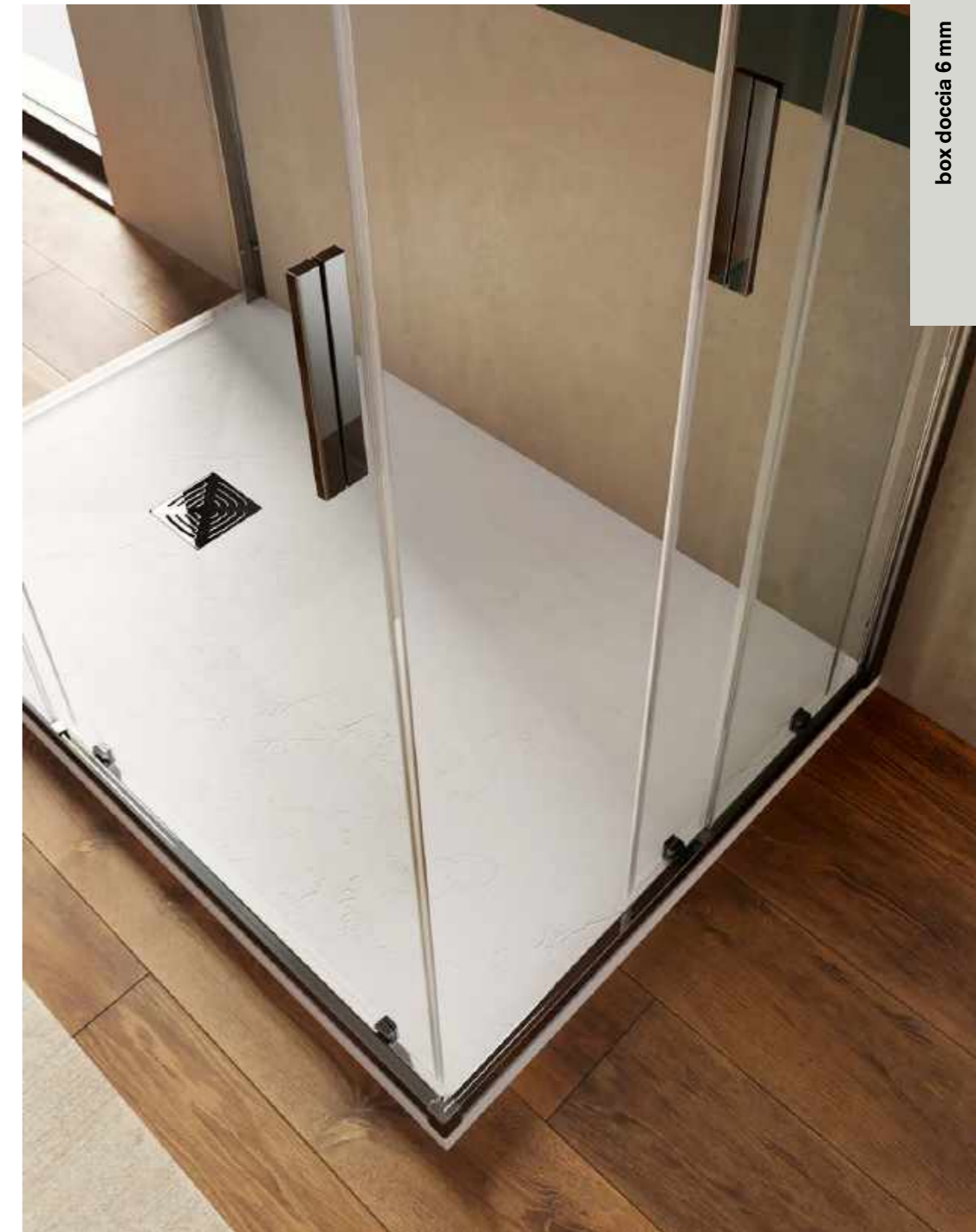

box doccia 6 mm

# EASYFLEX

Singolo lato per box doccia scorrevole apertura ad angolo\_Single sliding panel corner opening for shower box **H 2000 mm**

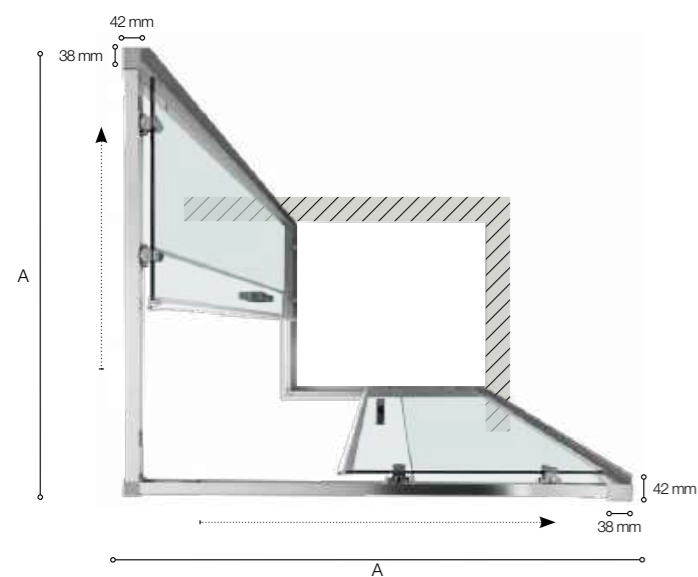

Versione angolare DX  
Right corner version

**APERTURA PORTA**  
OPENING DOOR

FLEX MM	700	720	750	800	850	900	1000	1100	1200	1300	1400
700	344	350	362	380	390	423	465	509	554	599	646
720	350	359	370	389	396	428	570	514	558	603	649
750	362	370	380	398	405	437	478	521	565	610	655
800	380	389	398	415	422	453	492	534	577	621	665
850	390	396	405	422	440	459	495	535	576	620	663
900	423	428	437	453	458	485	523	562	603	645	688
1000	465	470	478	492	495	523	556	592	630	669	714
1100	509	514	521	534	535	562	592	627	663	700	742
1200	554	558	565	577	576	603	630	663	698	734	773
1300	599	603	610	621	620	645	669	700	734	769	805
1400	646	649	655	665	663	688	714	742	773	805	839

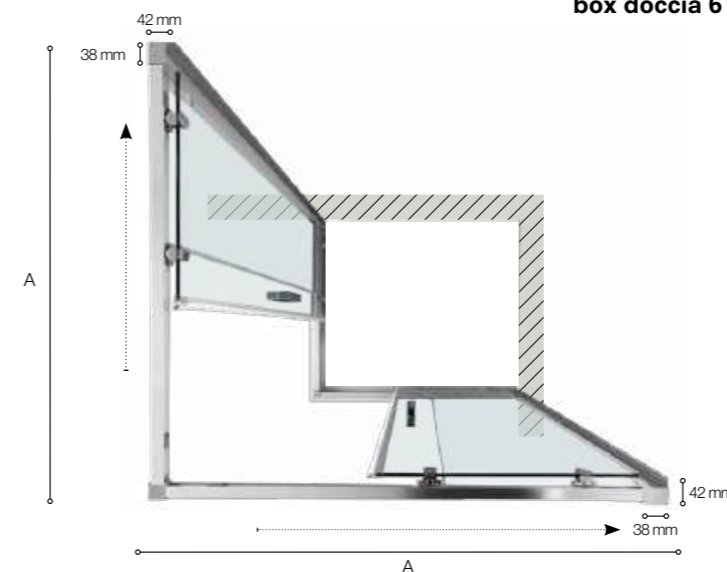

Versione angolare DX  
Right corner version

**SINGOLO LATO PER BOX DOCCIA SCORREVOLE (SOMMARE DUE LATI)**  
SINGLE SLIDING PANEL FOR SHOWER BOX (COMBINE TWO SIDES)

Specifiche tecniche / Technical specifications			
P/D mm	H/H mm	Peso vetro kg Glass weight kgs	Estensibilità mm Extension mm
700	2000	23	665 - 690
720	2000	24	685 - 710
750	2000	25	715 - 740
800	2000	26	765 - 790
850	2000	28	815 - 840

Specifiche tecniche / Technical specifications			
P/D mm	H/H mm	Peso vetro kg Glass weight kgs	Estensibilità mm Extension mm
900	2000	29	865 - 890
1000	2000	32	965 - 990
1100	2000	35	1065 - 1090
1200	2000	38	1165 - 1190
1300	2000	41	1265 - 1290
1400	2000	44	1365 - 1390

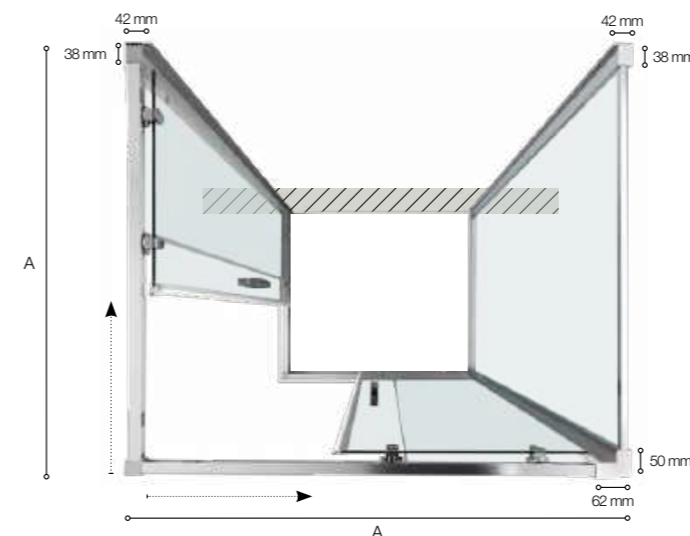

Versione centro parete  
Center wall version

**BOX DOCCIA SCORREVOLE CENTRO PARETE (SOMMARE DUE LATI + LATO FISSO)**  
SHOWER BOX CENTER WALL (COMBINE TWO SIDES + FIXED PANEL)

Specifiche tecniche / Technical specifications			
P/D mm	H/H mm	Peso vetro kg Glass weight kgs	Estensibilità mm Extension mm
700	2000	23	677 - 702
720	2000	24	697 - 722
750	2000	25	727 - 752
800	2000	26	777 - 802
850	2000	28	827 - 852
900	2000	29	877 - 902
1000	2000	32	977 - 1062
1100	2000	35	1077 - 1102
1200	2000	38	1177 - 1202
1300	2000	41	1277 - 1302
1400	2000	44	1377 - 1402

**DIMENSIONI LATO FISSO (B)**  
FIXED SIDE PANEL SIZE (B)

Specifiche tecniche / Technical specifications			
P/D mm	H/H mm	Peso vetro kg Glass weight kgs	Estensibilità mm Extension mm
700	2000	24	665 - 690
800	2000	27	765 - 790
900	2000	30	865 - 890
1000	2000	34	965 - 990



# FS40

L'FS40 è il box doccia per piatti doccia semicircolari o a pianta rettangolare/semicircolare. Una cabina doccia angolare con doppia anta scorrevole e profili dai dettagli puliti ed essenziali.

The FS40 is a sliding door shower enclosure for semi-circular or rectangular/semi-circular trays. This corner shower enclosure boasts double sliding doors with clean, essential polished aluminum profiles.

## versioni\_versions

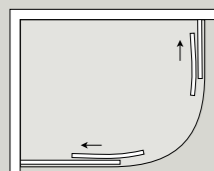

Doppia porta scorrevole  
Versione: Semicircolare rettangolare

Double sliding door  
Version: Semi-circular rectangular

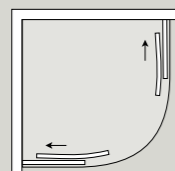

Doppia porta scorrevole  
Versione: Semicircolare

Double sliding door  
Version: Semi-circular

## caratteristiche tecniche\_technical characteristics



easy clean

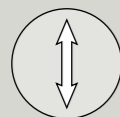

**h 2000 mm**  
altezza  
height

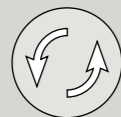

reversibile  
reversible

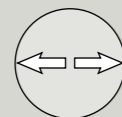

**25 mm**  
regolazione  
adjustment



**6 mm**  
cristallo temperato  
tempered glass



**TPAEF11**  
**+30 mm**  
profilo di allungamento  
adjustable profile



sgancio rapido  
quick release

## finiture\_finishes



cromo  
chrome

## cristallo\_glass

Cristallo satinato  
Frosted glass

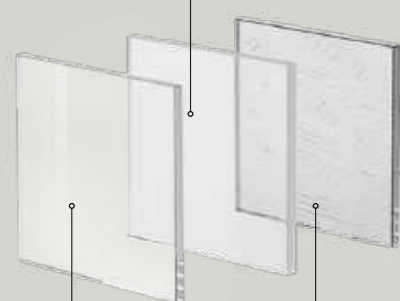

Cristallo trasparente  
Transparent glass

Cristallo Cincillà  
Chinchilla glass



FS40  
semicircolare rettangolare  
semi-circular rectangular



**Sirena**  
colonna doccia  
shower column

**Flat**  
piatto doccia Antracite  
Anthracite shower tray



Il sistema a doppia anta la rende ideale per piccoli ambienti e risolve con comodità eventuali problemi di spazio ingresso/uscita dalla doccia. Le misure standard e l'estensibilità dei profili ne fanno il prodotto ideale per tutti i modelli piatto doccia semicircolari.

The double door system has been engineered for small bathroom environments and resolves most shower entry issues. The FS40 standard sizes together with the extendibility of the profiles make it the ideal enclosure for most shower trays.



**FS40**  
semicircolare semi-circular

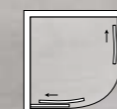

**Nettuno**  
colonna doccia  
shower column

**Flat**  
piatto doccia Bianco  
White shower tray

# FS40

Box doccia semicircolare con doppia anta scorrevole\_ Semi-circular shower enclosure with double liding door **H 2000 mm**

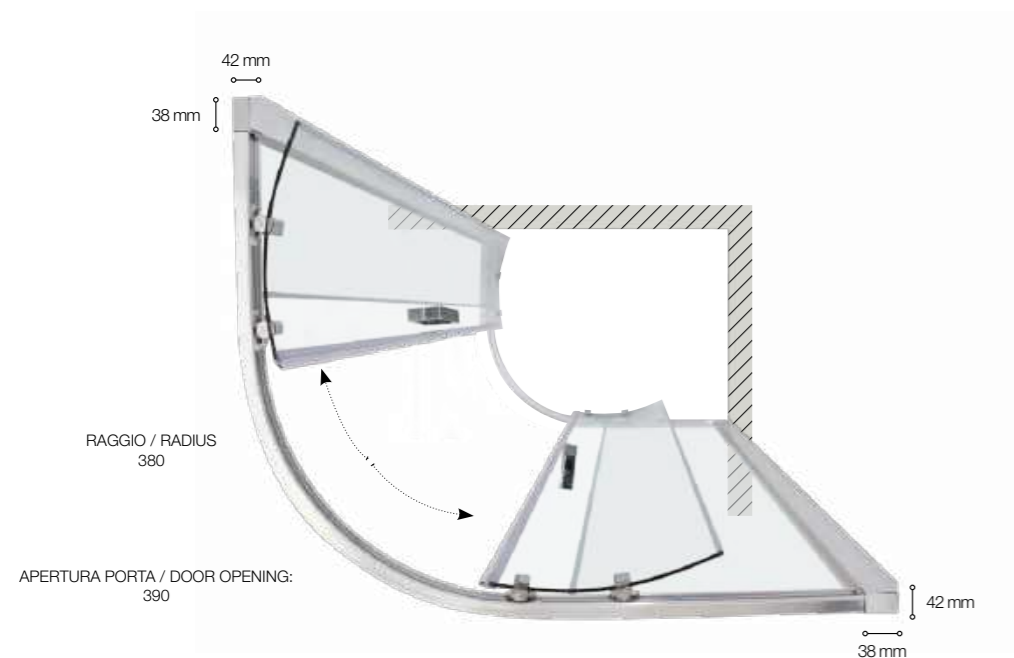

Versione semicircolare rettangolare  
Semi-circular rectangular version

## BOX COMPLETO COMPLETE SHOWER ENCLOSURE

Specifiche tecniche / Technical specifications							
DA ABBINARE A PIATTO DOCCIA TO MATCH WITH SHOWER TRAY							
L/W	P/D	RAGGIO	H/H	Peso vetro kg Glass weight kgs	Apertura porta Door opening	Estensibilità L mm Extension W mm	Estensibilità P mm Extension D mm
mm	mm	mm	mm				
720	900	380	2000	48	390	685 - 710	865 - 890
800	1000	380	2000	53	390	765 - 790	965 - 990
800	1200	380	2000	62	390	765 - 790	1165 - 1190

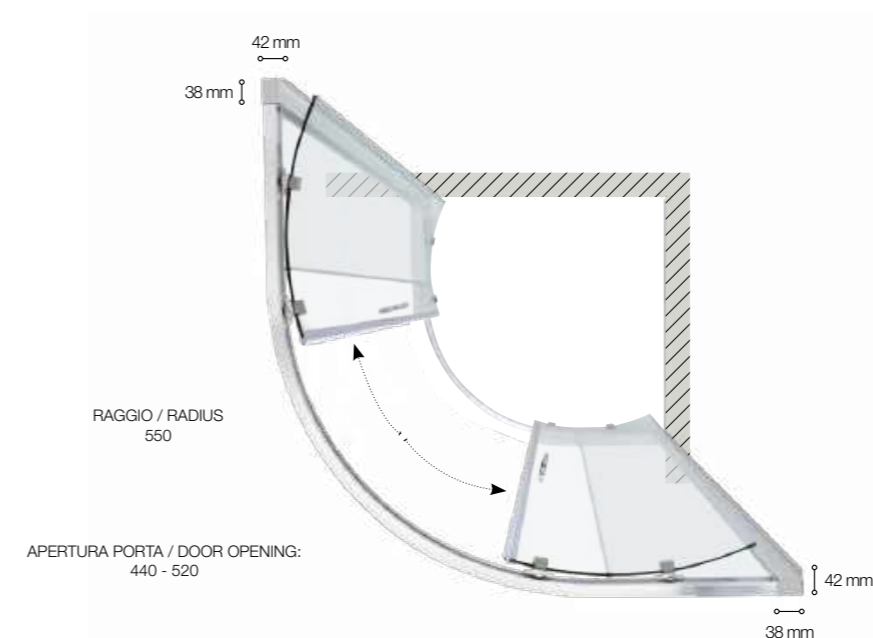

Versione semicircolare  
Semi-circular version

## BOX COMPLETO COMPLETE SHOWER ENCLOSURE

Specifiche tecniche / Technical specifications							
DA ABBINARE A PIATTO DOCCIA TO MATCH WITH SHOWER TRAY							
L/W	P/D	RAGGIO	H/H	Peso vetro kg Glass weight kgs	Apertura porta Door opening	Estensibilità L mm Extension W mm	Estensibilità P mm Extension D mm
mm	mm	mm	mm				
800	800	550	2000	45	440	765 - 790	765 - 790
900	900	550	2000	51	520	865 - 890	865 - 890
1000	1000	550	2000	55	520	965 - 990	965 - 990

# ECO LATO

La cabina ECO LATO si caratterizza per l'altezza ridotta, di solo 1900 mm. I singoli lati si assemblano tra di loro tramite ante scorrevoli, andando a comporre il box doccia.

The ECO LATO shower enclosure is characterized by its low height, measuring only 1900 mm. The individual panels come together through sliding doors, creating the shower enclosure.

## versioni\_versions

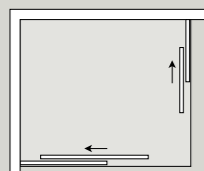

Porta scorrevole  
Versione: Angolo

Sliding door  
Version: Corner

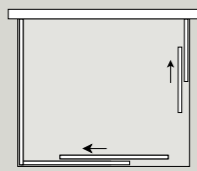

Porta scorrevole  
Versione: Centro parete

Sliding door  
Version: Center wall

## caratteristiche tecniche\_technical characteristics



**h 1900 mm**  
altezza  
height



reversibile  
reversible

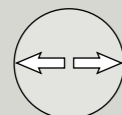

**20 mm**  
regolazione  
adjustment



**6 mm**  
cristallo temperato  
tempered glass

TPAE09



**+30 mm**  
profilo di allungamento  
adjustable profile



sgancio rapido  
quick release

## finiture\_finishes



cromo  
chrome

## cristallo\_glass

Cristallo satinato  
Frosted glass

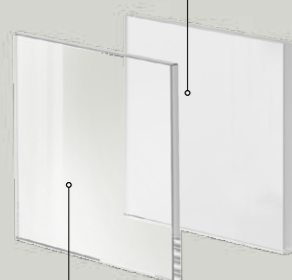

Cristallo trasparente  
Transparent glass



ECO LATO  
angolo\_corner



**Diana**  
colonna doccia  
shower column

**Flat bordo**  
piatto doccia Antracite  
Anthracite shower tray



ECO LATO  
angolo\_corner

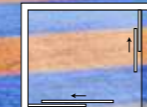

Pretoria  
colonna doccia  
shower column

Ceramic.30  
piatto doccia Bianco matt  
White matt shower tray



ECO LATO + ECOFIS  
centro parete\_center wall



**Gaia**  
colonna doccia  
shower column

**Flat bordo**  
piatto doccia Bianco  
White shower tray



box doccia 6 mm

Il sistema a doppia anta la rende ideale per piccoli ambienti e risolve con comodità eventuali problemi di spazio ingresso/uscita dalla doccia.

The double door system has been engineered for small bathroom environments and resolves most shower entry issues.



# ECO LATO

Singolo lato per box doccia scorrevole ad angolo\_Single sliding panel corner opening for shower box **H 1900 mm**

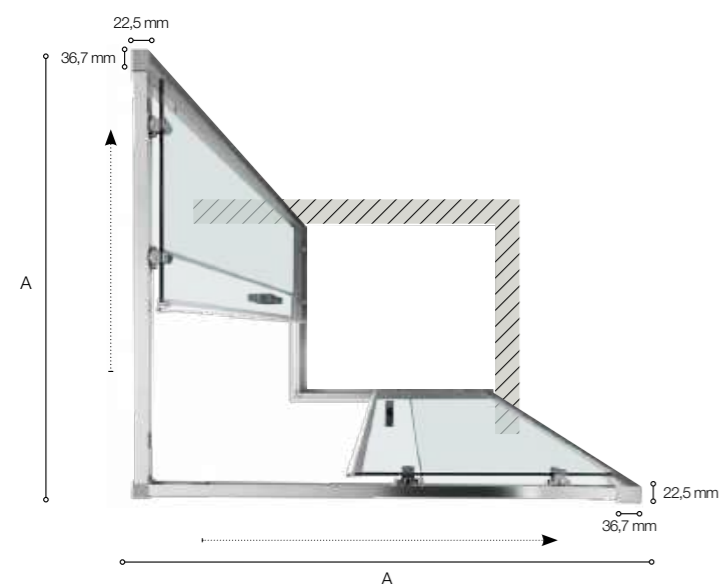

Versione angolare DX  
Right corner version

## APERTURA PORTA OPENING DOOR

ECO MM	700	720	750	800	900	1000	1200
700	336	343	354	373	413	454	542
720	343	350	361	379	418	460	547
750	354	361	371	389	428	468	554
800	373	379	389	407	443	482	566
900	413	418	428	443	477	514	593
1000	454	460	468	482	514	548	623
1200	542	547	554	566	593	623	689

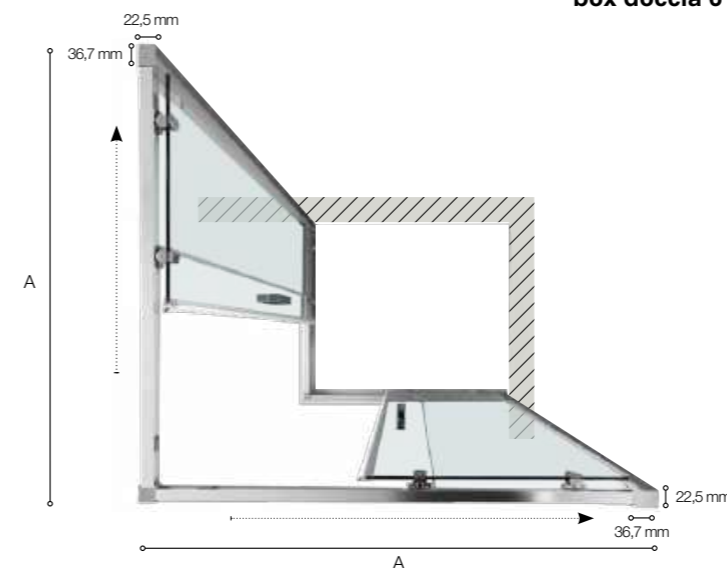

Versione angolare DX  
Right corner version

## SINGOLO LATO PER BOX DOCCIA SCORREVOLE (SOMMARE DUE LATI) SINGLE SLIDING PANEL FOR SHOWER BOX (COMBINE TWO SIDES)

Specifiche tecniche / Technical specifications			
P/D	H/H	Peso vetro kg	Estensibilità mm
mm	mm	Glass weight kgs	Extension mm
700	1900	22	665 - 685
720	1900	22,5	685 - 705
750	1900	23	715 - 735
800	1900	25	765 - 785

Specifiche tecniche / Technical specifications			
P/D	H/H	Peso vetro kg	Estensibilità mm
mm	mm	Glass weight kgs	Extension mm
900	1900	28	865 - 885
1000	1900	31	965 - 985
1200	1900	36	1165 - 1185

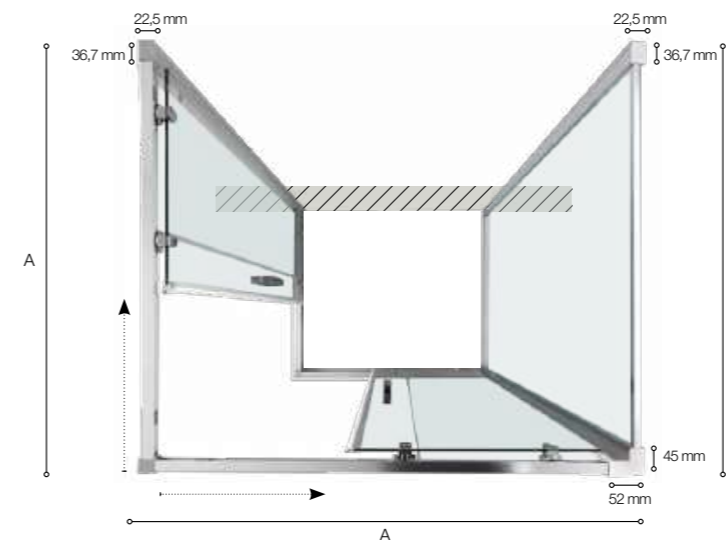

Versione centro parete  
Center wall version

## BOX DOCCIA SCORREVOLE CENTRO PARETE (SOMMARE DUE LATI + LATO FISSO) SHOWER BOX CENTER WALL (COMBINE TWO SIDES + FIXED PANEL)

Specifiche tecniche / Technical specifications			
P/D	H/H	Peso vetro kg	Estensibilità mm
mm	mm	Glass weight kgs	Extension mm
700	1900	22	672 - 692
720	1900	22,5	692 - 712
750	1900	23	722 - 742
800	1900	25	772 - 792
900	1900	28	872 - 892
1000	1900	31	972 - 992
1200	1900	36	1172 - 1192

## DIMENSIONI LATO FISSO (B) FIXED SIDE PANEL SIZE (B)

Specifiche tecniche / Technical specifications			
P/D	H/H	Peso vetro kg	Estensibilità mm
mm	mm	Glass weight kgs	Extension mm
700	1900	22	665 - 685
800	1900	25	765 - 785
900	1900	28	865 - 885

# ECO SEM

Il box doccia ECO SEM è disponibile anche in versione semicircolare. L'altezza ridotta, di soli 1900 mm si conferma come elemento distintivo.

The ECO SEM shower enclosure is also available in a semi-circular version. Its low height of only 1900 mm remains its distinctive feature.

## versioni\_versions

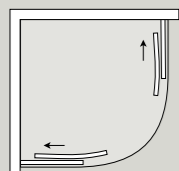

Porte scorrevoli  
Versione: Semicircolare

Sliding doors  
Version: Semi-circular

## caratteristiche tecniche\_technical characteristics

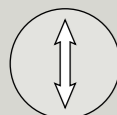

**h 1900 mm**  
altezza  
height

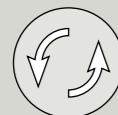

reversibile  
reversible

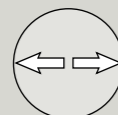

**20 mm**  
regolazione  
adjustment



**6 mm**  
cristallo temperato  
tempered glass



**TPAE09**  
**+30 mm**  
profilo di allungamento  
adjustable profile



sgancio rapido  
quick release

## finiture\_finishes



cromo  
chrome

## cristallo\_glass

Cristallo satinato  
Frosted glass



Cristallo trasparente  
Transparent glass



ECO SEM  
semicircolare semi-circular



**Nettuno**  
colonna doccia  
shower column

**Flat**  
piatto doccia Bianco  
White shower tray



# ECO SEM

Box doccia semicircolare con doppia anta scorrevole\_ Semi-circular shower enclosure with double liding door **H 1900 mm**



Il sistema a doppia anta la rende ideale per piccoli ambienti e risolve con comodità eventuali problemi di spazio ingresso/uscita dalla doccia. Le misure standard e l'estensibilità dei profili ne fanno il prodotto ideale per tutti i modelli piatto doccia semicircolari.

The double door system has been engineered for small bathroom environments and resolves most shower entry issues. The standard sizes together with the extendibility of the profiles make it the ideal enclosure for most semicircular shower trays.

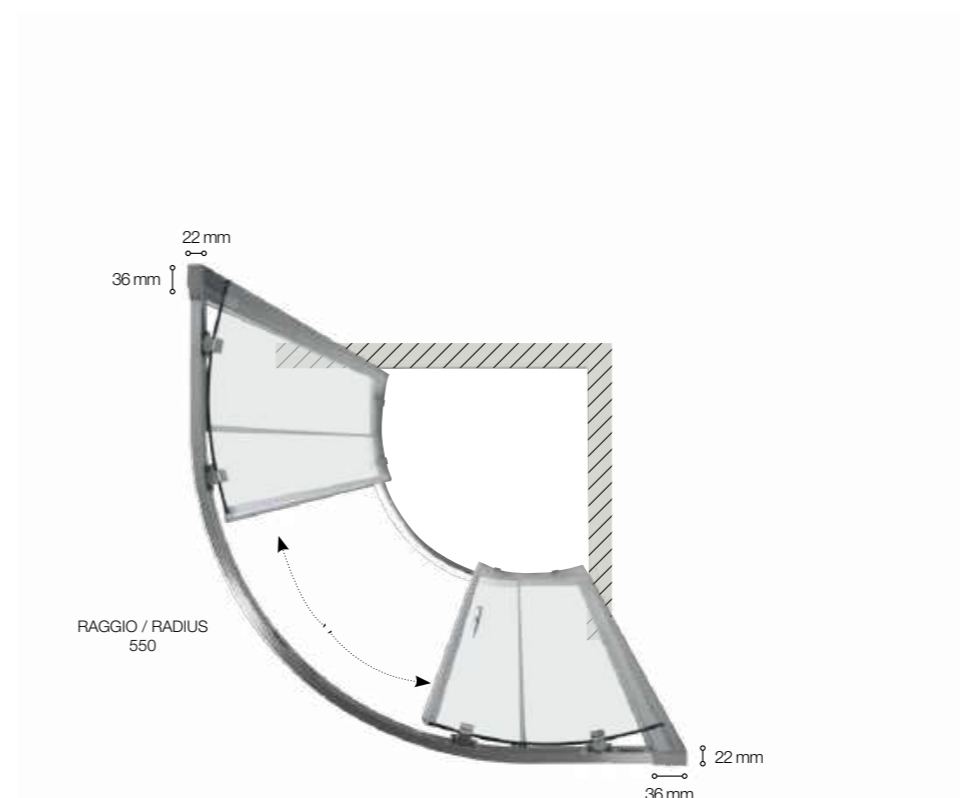

## BOX SEMI-CIRCOLARE SEMI-CIRCULAR SHOWER ENCLOSURE

### Specifiche tecniche / Technical specifications

Piatto doccia Shower tray						
L/W	P/D	H/H	Peso vetro kg Glass weight kgs	Apertura porta Door opening	Estensibilità L mm Extension W mm	Estensibilità P mm Extension D mm
800	800	1900	41	442	765 - 785	765 - 785
900	900	1900	46	542	865 - 885	865 - 885

# ECOPSC50

Un box doccia ad ante scorrevoli versatile, disponibile per installazione a nicchia, ad angolo o a centro parete. L'altezza è di 1900 mm. Disponibile in finitura cromo.

A versatile shower enclosure with sliding doors, available for niche, corner, or center wall installation. It has a height of 1900 mm and is available in chrome finish.

## versioni\_versions

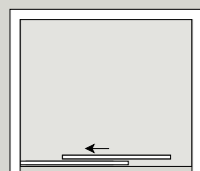

Porta scorrevole  
Versione: Nicchia

Sliding door  
Version: Niche

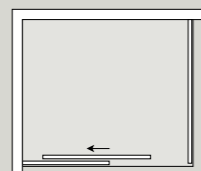

Porta scorrevole  
Versione: Angolo

Sliding door  
Version: Corner

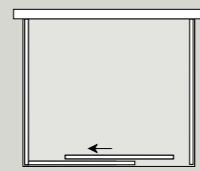

Porta scorrevole  
Versione: Centro parete

Sliding door  
Version: Center wall

## caratteristiche tecniche\_technical characteristics



**h 1900 mm**  
altezza  
height

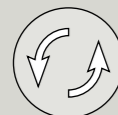

reversibile  
reversible

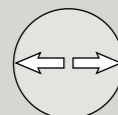

**40 mm**  
regolazione  
adjustment



**6 mm**  
cristallo temperato  
tempered glass



**TPAE13**  
**+30 mm**  
profilo di allungamento  
adjustable profile



sgancio rapido  
quick release

## finiture\_finishes



cromo  
chrome

## cristallo\_glass

Cristallo satinato  
Frosted glass

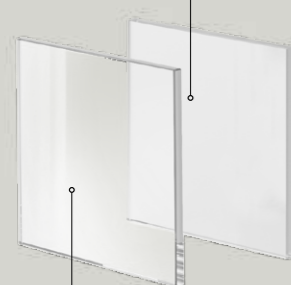

Cristallo trasparente  
Transparent glass

box doccia 6 mm / 6 mm shower box

box doccia 6 mm



ECOPSC50  
nicchia\_niche



**Sirena**  
colonna doccia  
shower column

**Ceramic.30**  
piatto doccia Bianco matt  
White matt shower tray



**ECOPSC50 + ECOFIS**  
angolo\_corner

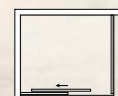

**Diana**  
colonna doccia  
shower column

**Ceramic.30**  
piatto doccia Bianco matt  
White matt shower tray





**ECOPSC50 + ECOFIS**  
centro parete\_center wall



**Gaia**  
colonna doccia  
shower column

**Ceramic.30**  
piatto doccia Bianco matt  
White matt shower tray

Questo box doccia, disponibile nelle versioni con cristallo trasparente o satinato, mantiene un'estetica essenziale e la massima funzionalità. I profili sono decisi; il sistema di sgancio rapido dell'anta scorrevole facilita le operazioni di pulizia.

This shower enclosure, available in versions with transparent or frosted glass, still has an essential aesthetic and maximum functionality. The profiles are bold, while the quick-release system of the sliding door facilitates cleaning operations.



# ECOPSC50

Porta scorrevole\_Sliding door **H 1900 mm**

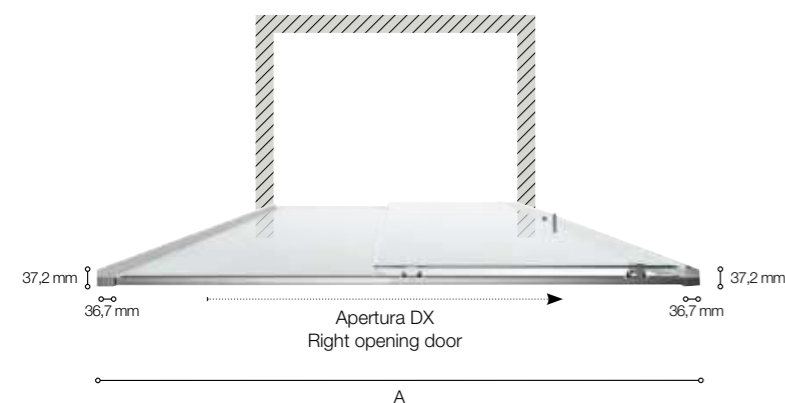

Versione nicchia  
Niche version

## DIMENSIONI PORTA (A) (NICCHIA)

DOOR SIZES (A) (NICHE)

Specifiche tecniche / Technical specifications				
L/W	H/H	Peso vetro kg	Apertura porta	Estensibilità mm
mm	mm	Glass weight kgs	Door opening	Extension mm
1000	1900	32	386	960 - 1000
1100	1900	35	436	1060 - 1100
1200	1900	38	486	1160 - 1200
1300	1900	41	536	1260 - 1300
1400	1900	44	586	1360 - 1400

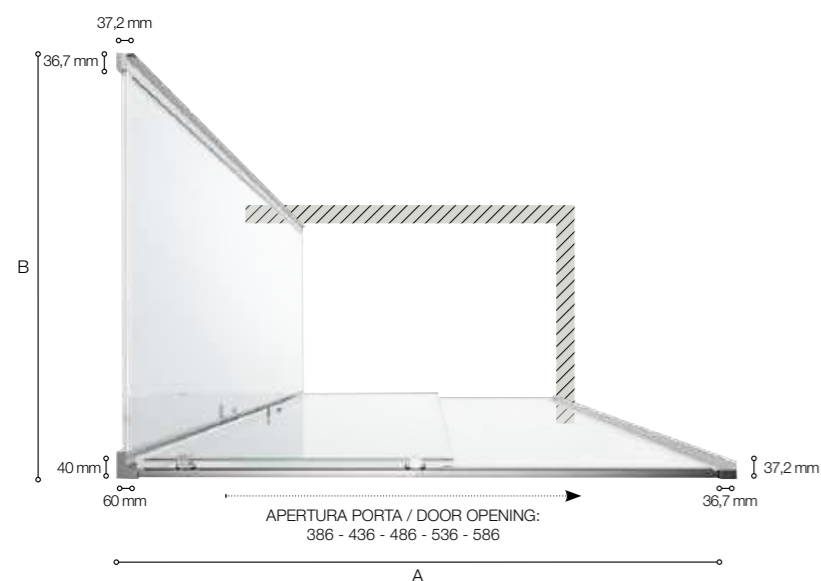

Versione Angolare DX  
Right Corner Version

## PORTA ABBINATA A LATO FISSO

DOOR MATCHED WITH FIXED PANEL

Specifiche tecniche / Technical specifications		
P/D	H/H	Estensibilità mm
mm	mm	Extension mm
1000	1900	967 - 1007
1100	1900	1067 - 1107
1200	1900	1167 - 1207
1300	1900	1267 - 1307
1400	1900	1367 - 1407

## DIMENSIONI LATO FISSO (B)

FIXED SIDE PANEL SIZE (B)

Specifiche tecniche / Technical specifications			
P/D	H/H	Peso vetro kg	Estensibilità mm
mm	mm	Glass weight kgs	Extension mm
700	1900	22	665 - 705
800	1900	25	765 - 805
900	1900	28	865 - 905



Versione Angolare DX  
Right Corner Version

## PORTA ABBINATA A LATO FISSO

DOOR MATCHED WITH FIXED PANEL

Specifiche tecniche / Technical specifications		
P/D	H/H	Estensibilità mm
mm	mm	Extension mm
1000	1900	974 - 1014
1100	1900	1074 - 1114
1200	1900	1174 - 1214
1300	1900	1274 - 1314
1400	1900	1374 - 1414

## DIMENSIONI LATO FISSO (B)

FIXED SIDE PANEL SIZE (B)

Specifiche tecniche / Technical specifications			
P/D	H/H	Peso vetro kg	Estensibilità mm
mm	mm	Glass weight kgs	Extension mm
700	1900	22	665 - 705
800	1900	25	765 - 805
900	1900	28	865 - 905

# SWING

## cromo

La porta battente e reversibile del box doccia SWING ne aumenta il comfort. Disponibile con porta battente doppia per l'installazione ad angolo.

The hinge and reversible door enhances the comfort of the SWING shower enclosure. It is also available with a double hinge door for corner installation.

### versioni\_versions

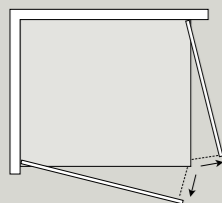

Doppia porta battente  
Versione: Angolo

Double hinge door  
Version: Corner

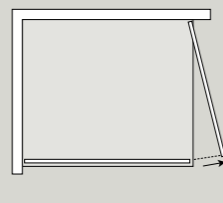

Porta battente  
Versione: Angolo

Hinge door  
Version: Corner

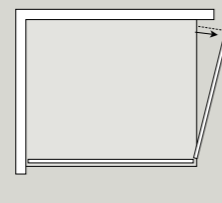

Porta battente  
per chiusura lato muro  
Versione: Angolo

Hinge door  
for wall-side closure  
Version: Corner

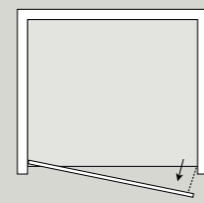

Porta battente  
Versione: Nicchia

Hinge door  
Version: Niche

### caratteristiche tecniche\_technical characteristics



easy clean

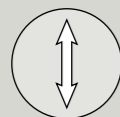

**h 2000 mm**  
altezza  
height

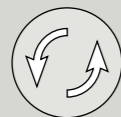

reversibile  
reversible

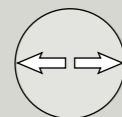

**25 mm**  
regolazione  
adjustment



**6 mm**  
cristallo temperato  
tempered glass



**TPA10**  
**+25 mm**  
profilo di allungamento  
adjustable profile

### finiture\_finishes



cromo  
chrome

### cristallo\_glass



Cristallo trasparente  
Transparent glass



SWING CROMO  
nicchia\_niche



**Diana**  
colonna doccia  
shower column

**Flat**  
piatto doccia Bianco  
White shower tray



**SWING CROMO**  
nicchia\_niche

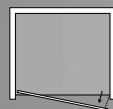

**Pretoria**  
colonna doccia  
shower column

**Ceramic.30**  
piatto doccia Bianco matt  
White matt shower tray



**SWING CROMO DOPPIA PORTA**  
angolo\_corner

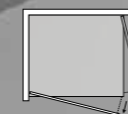

**Pretoria**  
colonna doccia  
shower column

**Ceramic.30**  
piatto doccia Bianco matt  
White matt shower tray



**SWING CROMO + PARETECR**  
angolo\_corner

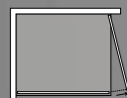

**Pretoria**  
colonna doccia  
shower column

**Ceramic.30**  
piatto doccia Bianco matt  
White matt shower tray



**SWING CROMO + SALFIS**  
per chiusura lato muro\_for wall-side closure  
angolo\_corner



**Pretoria**  
colonna doccia  
shower column

**Ceramic.30**  
piatto doccia Bianco matt  
White matt shower tray



# SWING cromo

Box doccia anta battente\_Hinge door shower box **H 2000 mm**

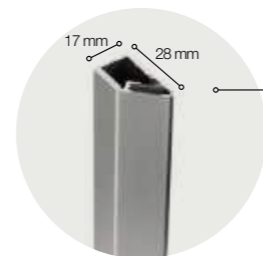
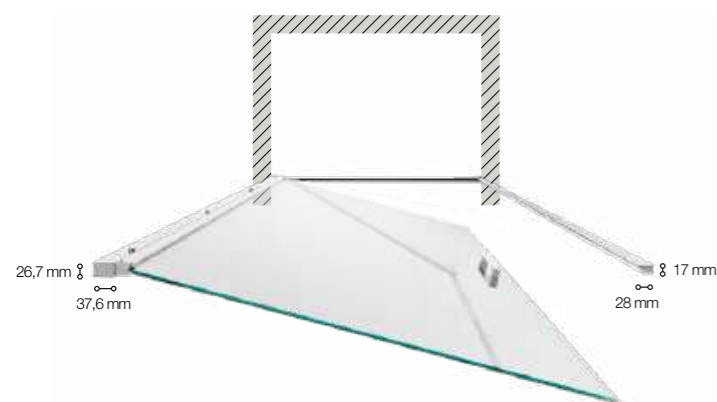

## NTPC03

Profilo chiusura /  
Closing profile

Per / For Art.  
TEPB43 - TPS35 -  
TPB72 - SWING -  
INFINITY

**DIMENSIONI PORTA (A) (NICCHIA) CON PROFILO CHIUSURA NTPC03**  
DOOR SIZES (A) (NICHE) WITH CLOSING PROFILE NTPC03

Specifiche tecniche / Technical specifications					
L/W	H/H	Peso vetro kg	Apertura porta	Ingombro porta	Estensibilità mm
mm	mm	Glass weight kgs	Door opening	Clumbed door	Extension mm
650	2000	23	536	546	630 - 655
700	2000	25	586	596	680 - 705
750	2000	27	636	646	730 - 755
800	2000	28	686	696	780 - 805
850	2000	30	736	746	830 - 855
900	2000	32	786	796	880 - 905

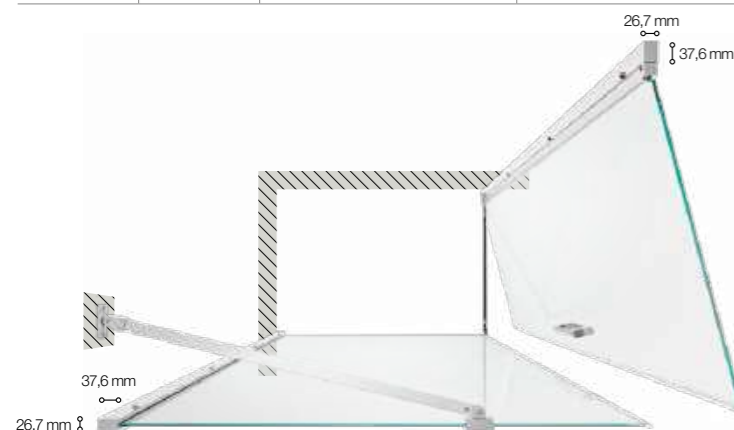

**PORTA ABBINATA A LATO FISSO PARETE**  
DOOR MATCHED WITH FIXED PANEL PARETE

Specifiche tecniche / Technical specifications					
L/W	H/H	Peso vetro kg	Apertura porta	Ingombro porta	Estensibilità mm
mm	mm	Glass weight kgs	Door opening	Clumbed door	Extension mm
650	2000	23	539	546	620 - 645
700	2000	25	589	596	670 - 695
750	2000	27	639	646	720 - 745
800	2000	28	689	696	770 - 795
850	2000	30	739	746	820 - 845
900	2000	32	789	796	870 - 895

**DIMENSIONI LATO FISSO (B)**  
FIXED SIDE PANEL SIZE (B)

Specifiche tecniche / Technical specifications				
P/D	H/H	Peso vetro kg	Estensibilità mm	
mm	mm	Glass weight kgs	Extension mm	
650	2007	22	630 - 655	
700	2007	23	680 - 705	
750	2007	27	730 - 755	
800	2007	28	780 - 805	
850	2007	29	830 - 855	
900	2007	31	880 - 905	
950	2007	33	930 - 955	
1000	2007	35	980 - 1005	
1100	2007	37	1080 - 1105	
1200	2007	40	1180 - 1205	
1300	2007	44	1280 - 1305	
1400	2007	47	1380 - 1405	

box doccia 6 mm / 6 mm shower box

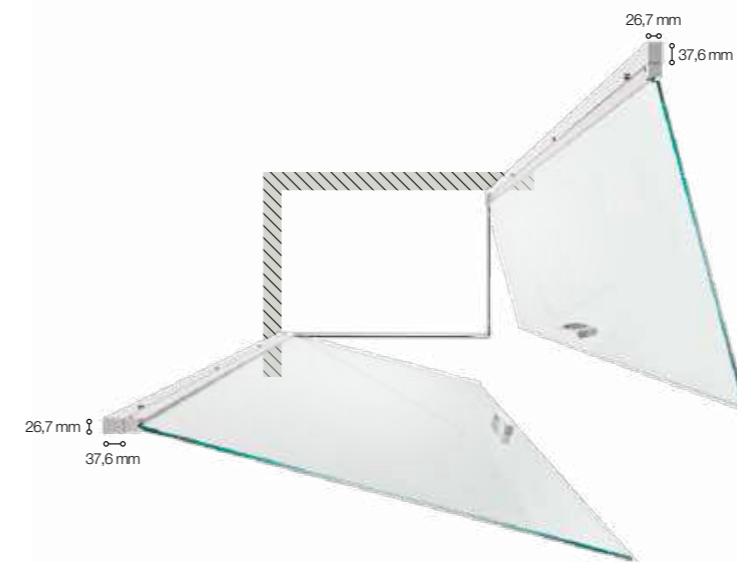

**DIMENSIONI DOPPIA PORTA (A)**  
DOUBLE DOOR SIZES (A)

Specifiche tecniche / Technical specifications			
L/W	H/H	Peso vetro kg	Estensibilità mm
mm	mm	Glass weight kgs	Extension mm
650	2000	23	620 - 645
700	2000	25	670 - 695
750	2000	27	720 - 745
800	2000	28	770 - 795
850	2000	30	820 - 845
900	2000	32	870 - 895

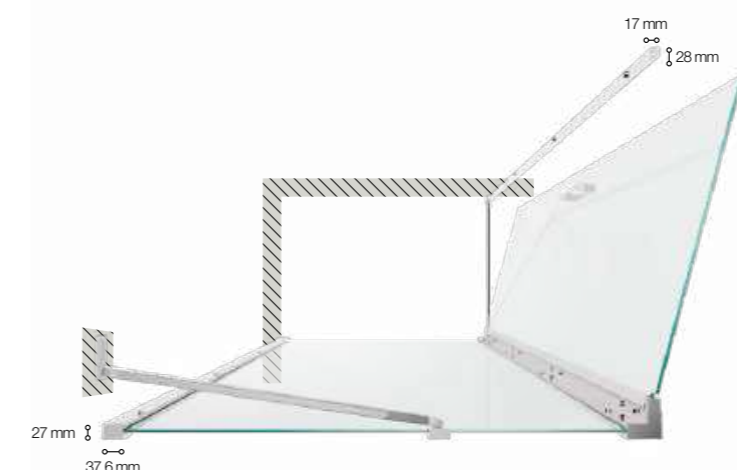

**PORTA ABBINATA A LATO FISSO SALFIS**  
DOOR MATCHED WITH FIXED PANEL SALFIS

Specifiche tecniche / Technical specifications					
L/W	H/H	Peso vetro kg	Apertura porta	Ingombro porta	Estensibilità mm
mm	mm	Glass weight kgs	Door opening	Clumbed door	Extension mm
650	2000	23	536	546	640 - 665
700	2000	25	586	596	690 - 715
750	2000	27	636	646	740 - 765
800	2000	28	686	696	790 - 815
850	2000	30	736	746	840 - 865
900	2000	32	786	796	890 - 915

**DIMENSIONI LATO FISSO SALFIS (B)**  
FIXED SIDE PANEL SIZE SALFIS (B)

Specifiche tecniche / Technical specifications				
P/D	H/H	Peso vetro kg	Estensibilità mm	
mm	mm	Glass weight kgs	Extension mm	
700	2030	23	665 - 715	
800	2030	28	765 - 815	
900	2030	31	865 - 915	
1000	2030	35	965 - 1015	

# SWING

## nera

Il profilo nero, in abbinamento con le maniglie, regala uno stile deciso e contemporaneo al box doccia SWING. La porta battente, reversibile, ne aumenta il comfort.

The black profile, in combination with the handles, adds a bold and contemporary style to the SWING shower enclosure. The hinge and reversible door enhances its comfort.

### versioni\_versions

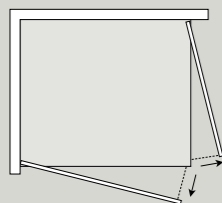

Doppia porta battente  
Versione: Angolo

Double hinge door  
Version: Corner

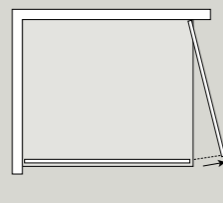

Porta battente  
Versione: Angolo

Hinge door  
Version: Corner

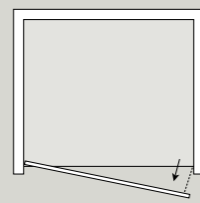

Porta battente  
Versione: Nicchia

Hinge door  
Version: Niche

### caratteristiche tecniche\_technical characteristics



easy clean

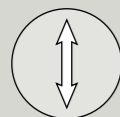

**h 2000 mm**  
altezza  
height

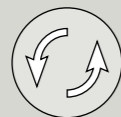

reversibile  
reversible

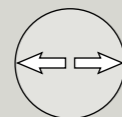

**25 mm**  
regolazione  
adjustment



**6 mm**  
cristallo temperato  
tempered glass

TPA10NE



**+25 mm**  
profilo di allungamento  
adjustable profile

### finiture\_finishes



nero matt  
black matt

### cristallo\_glass



Cristallo trasparente  
Transparent glass

### SWING NERA DOPPIA PORTA angolo\_corner

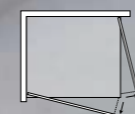

**Tritone**  
colonna doccia  
shower column

**Flat**  
piatto doccia Bianco  
White shower tray



SWING NERA DOPPIA PORTA  
angolo\_corner

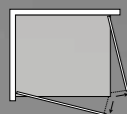

**Angelica**  
colonna doccia  
shower column

**Ceramic.30**  
piatto doccia Bianco matt  
White matt shower tray



SWING NERA + PARETENE  
angolo\_corner



**Angelica**  
colonna doccia  
shower column

**Ceramic.30**  
piatto doccia Bianco matt  
White matt shower tray

box doccia 6 mm



SWING NERA  
nicchia\_niche

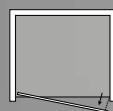

**Angelica**  
colonna doccia  
shower column

**Ceramic.30**  
piatto doccia Bianco matt  
White matt shower tray



# SWING nera

Box doccia anta battente\_Hinge door shower box **H 2000 mm**

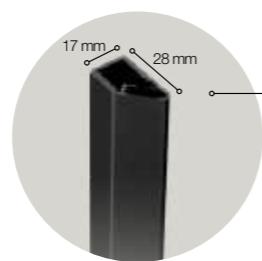
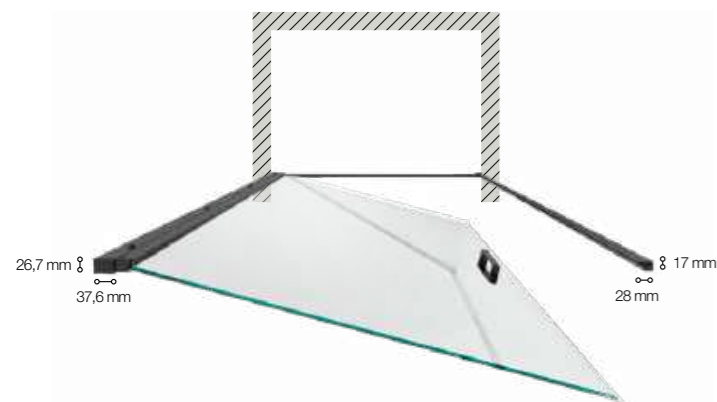

## NTPC03NE

Profilo chiusura /  
Closing profile

Per / For Art.  
SWING NERA

### DIMENSIONI PORTA (A) (NICCHIA) CON PROFILO CHIUSURA NTPC03NE

DOOR SIZES (A) (NICHE) WITH CLOSING PROFILE NTPC03NE

Specifiche tecniche / Technical specifications					
L/W	H/H	Peso vetro kg	Apertura porta	Ingombro porta	Estensibilità mm
mm	mm	Glass weight kgs	Door opening	Clumbed door	Extension mm
650	2000	23	536	546	630 - 655
700	2000	25	586	596	680 - 705
750	2000	27	636	646	730 - 755
800	2000	28	686	696	780 - 805
850	2000	30	736	746	830 - 855
900	2000	32	786	796	880 - 905



### PORTA ABBINATA A LATO FISSO PARETE NE

DOOR MATCHED WITH FIXED PANEL PARETE NE

Specifiche tecniche / Technical specifications					
L/W	H/H	Peso vetro kg	Apertura porta	Ingombro porta	Estensibilità mm
mm	mm	Glass weight kgs	Door opening	Clumbed door	Extension mm
650	2000	23	539	546	620 - 645
700	2000	25	589	596	670 - 695
750	2000	27	639	646	720 - 745
800	2000	28	689	696	770 - 795
850	2000	30	739	746	820 - 845
900	2000	32	789	796	870 - 895

### DIMENSIONI LATO FISSO (B)

FIXED SIDE PANEL SIZE (B)

Specifiche tecniche / Technical specifications			
P/D	H/H	Peso vetro kg	Estensibilità mm
mm	mm	Glass weight kgs	Extension mm
650	2007	22	630 - 655
700	2007	23	680 - 705
750	2007	27	730 - 755
800	2007	28	780 - 805
850	2007	29	830 - 855
900	2007	31	880 - 905
950	2007	33	930 - 955
1000	2007	35	980 - 1005
1100	2007	37	1080 - 1105
1200	2007	40	1180 - 1205
1300	2007	44	1280 - 1305
1400	2007	47	1380 - 1405

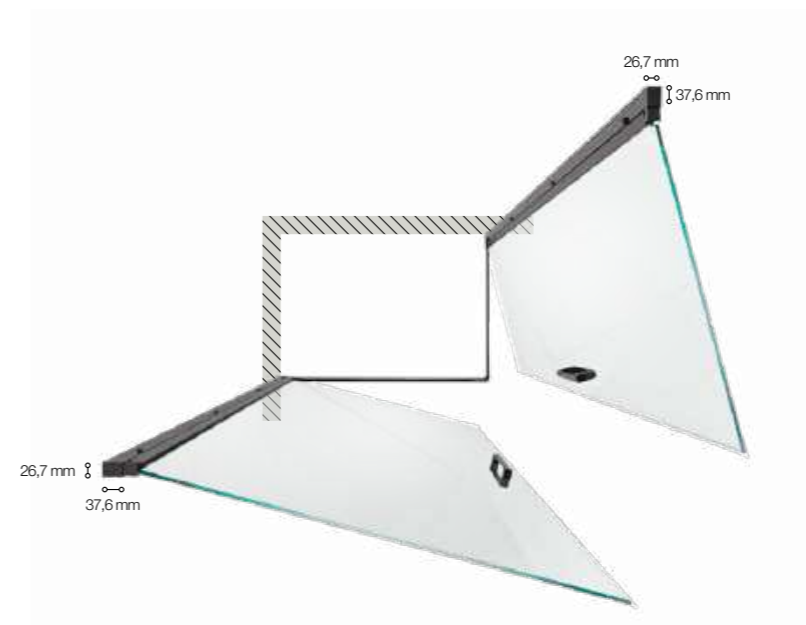

### DIMENSIONI DOPPIA PORTA (A)

DOUBLE DOOR SIZES (A)

Specifiche tecniche / Technical specifications			
L/W	H/H	Peso vetro kg	Estensibilità mm
mm	mm	Glass weight kgs	Extension mm
650	2000	23	620 - 645
700	2000	25	670 - 695
750	2000	27	720 - 745
800	2000	28	770 - 795
850	2000	30	820 - 845
900	2000	32	870 - 895

# SWING

## alluminio spazzolato

L'elegante profilo in alluminio spazzolato corre lungo i bordi laterali del box doccia. La porta battente reversibile rappresenta la caratteristica distintiva dei modelli SWING.

The elegant brushed profile runs along the side edges of the SWING shower enclosure. The reversible hinge door is the distinctive feature of the SWING models.

### versioni\_versions

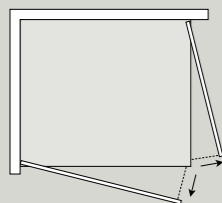

Doppia porta battente  
Versione: Angolo  
Double hinge door  
Version: Corner

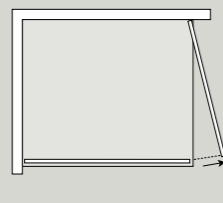

Porta battente  
Versione: Angolo  
Hinge door  
Version: Corner

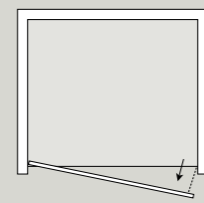

Porta battente  
Versione: Nicchia  
Hinge door  
Version: Niche

### caratteristiche tecniche\_technical characteristics



easy clean

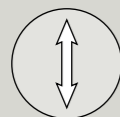

**h 2000 mm**  
altezza  
height



reversibile  
reversible

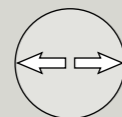

**25 mm**  
regolazione  
adjustment



**6 mm**  
cristallo temperato  
tempered glass



**+25 mm**  
profilo di allungamento  
adjustable profile

TPA10AS

### finiture\_finishes



alluminio spazzolato  
brushed nickel

### cristallo\_glass



Cristallo trasparente  
Transparent glass

box doccia 6 mm / 6 mm shower box

\_153



box doccia 6 mm

SWING ALLUMINIO SPAZZOLATO + PARETEAS  
angolo corner



**Diana**  
colonna doccia  
shower column

**Ceramic.30**  
piatto doccia Bianco matt  
White matt shower tray



SWING ALLUMINIO SPAZZOLATO + PARETEAS  
angolo\_corner



**Pretoria**  
colonna doccia  
shower column

**Ceramic.30**  
piatto doccia Bianco matt  
White matt shower tray



SWING ALLUMINIO SPAZZOLATO DOPPIA PORTA  
angolo\_corner



**Pretoria**  
colonna doccia  
shower column

**Ceramic.30**  
piatto doccia Bianco matt  
White matt shower tray



SWING ALLUMINIO SPAZZOLATO  
nicchia\_niche

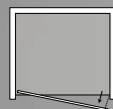

**Pretoria**  
colonna doccia  
shower column

**Ceramic.30**  
piatto doccia Bianco matt  
White matt shower tray





# SWING alluminio spazzolato

Box doccia anta battente\_Hinge door shower box **H 2000 mm**

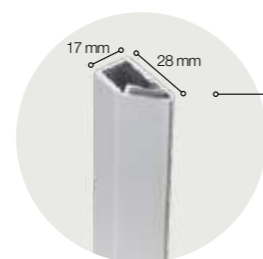
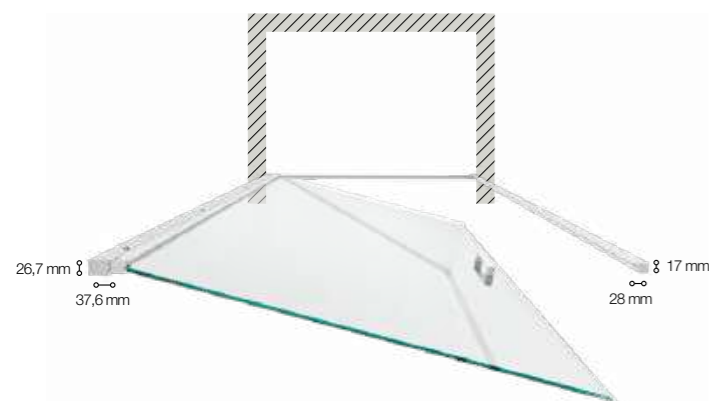

## NTPC03AS

Profilo chiusura /  
Closing profile

Per / For Art.  
SWING ALLUMINIO  
SPAZZOLATO

### DIMENSIONI PORTA (A) (NICCHIA) CON PROFILO CHIUSURA NTPC03AS

DOOR SIZES (A) (NICHE) WITH CLOSING PROFILE NTPC03AS

Specifiche tecniche / Technical specifications					
L/W	H/H	Peso vetro kg	Apertura porta	Ingombro porta	Estensibilità mm
mm	mm	Glass weight kgs	Door opening	Clumbed door	Extension mm
650	2000	23	536	546	630 - 655
700	2000	25	586	596	680 - 705
750	2000	27	636	646	730 - 755
800	2000	28	686	696	780 - 805
850	2000	30	736	746	830 - 855
900	2000	32	786	796	880 - 905

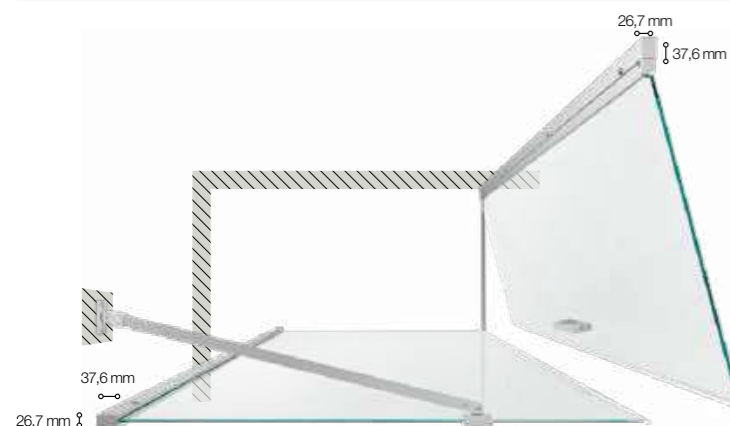

### PORTA ABBINATA A LATO FISSO PARETE

DOOR MATCHED WITH FIXED PANEL PARETE

Specifiche tecniche / Technical specifications					
L/W	H/H	Peso vetro kg	Apertura porta	Ingombro porta	Estensibilità mm
mm	mm	Glass weight kgs	Door opening	Clumbed door	Extension mm
650	2000	23	539	546	620 - 645
700	2000	25	589	596	670 - 695
750	2000	27	639	646	720 - 745
800	2000	28	689	696	770 - 795
850	2000	30	739	746	820 - 845
900	2000	32	789	796	870 - 895

### DIMENSIONI LATO FISSO (B)

FIXED SIDE PANEL SIZE (B)

Specifiche tecniche / Technical specifications			
P/D	H/H	Peso vetro kg	Estensibilità mm
mm	mm	Glass weight kgs	Extension mm
650	2007	22	630 - 655
700	2007	23	680 - 705
750	2007	27	730 - 755
800	2007	28	780 - 805
850	2007	29	830 - 855
900	2007	31	880 - 905
950	2007	33	930 - 955
1000	2007	35	980 - 1005
1100	2007	37	1080 - 1105
1200	2007	40	1180 - 1205
1300	2007	44	1280 - 1305
1400	2007	47	1380 - 1405

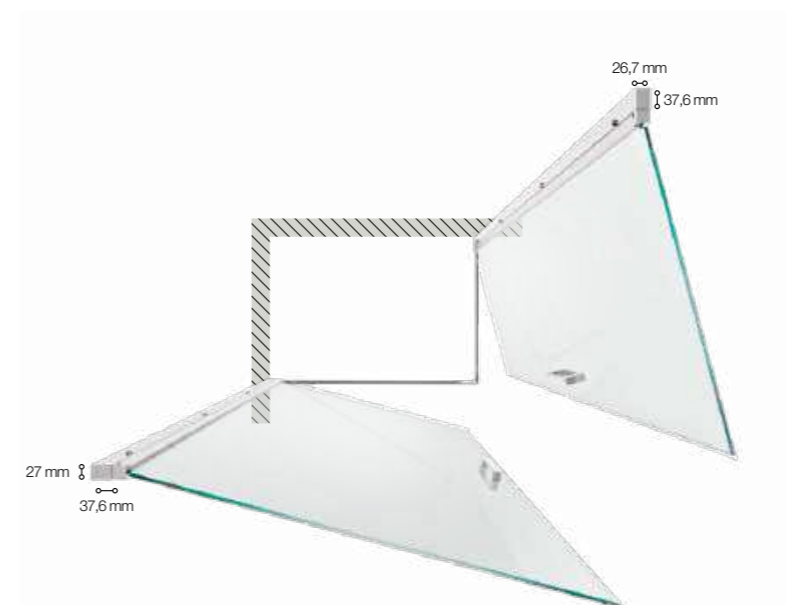

### DIMENSIONI PORTA DOPPIA PORTA (A)

DOUBLE DOOR SIZES (A)

Specifiche tecniche / Technical specifications			
L/W	H/H	Peso vetro kg	Estensibilità mm
mm	mm	Glass weight kgs	Extension mm
650	2000	23	620 - 645
700	2000	25	670 - 695
750	2000	27	720 - 745
800	2000	28	770 - 795
850	2000	30	820 - 845
900	2000	32	870 - 895

# TEPB43

La soluzione a battente di TEPB43 è semplice e pulita grazie al braccetto di irrigidimento in acciaio che assicura e sostiene le lastre di vetro, tenute insieme da cerniere dalla linea squadrata.

The TEPB43 hinged shower enclosure is simple and clean thanks to the stainless steel brackets which secure the glass panels. The glass panels are joined together with square-shaped hinges.

## versioni\_versions

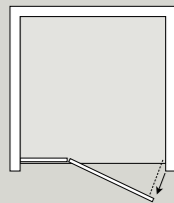

Porta battente  
Versione: Nicchia  
Hinge door  
Version: Niche

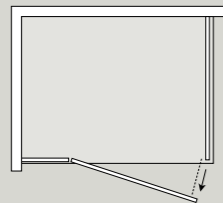

Porta battente  
Versione: Angolo  
Hinge door  
Version: Corner

## caratteristiche tecniche\_technical characteristics



easy clean

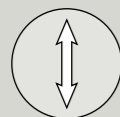

**h 2007 mm**  
altezza  
height

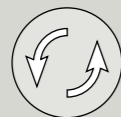

reversibile  
reversible

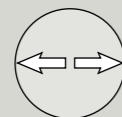

**15 mm**  
regolazione  
adjustment



**6 mm**  
cristallo temperato  
tempered glass



**NTPA01**  
**+30 mm**  
profilo di allungamento  
adjustable profile

## finiture\_finishes



cromo  
chrome

## cristallo\_glass



Cristallo trasparente  
Transparent glass

box doccia 6 mm / 6 mm shower box

TEPB43  
nicchia\_niche



**Nettuno**  
colonna doccia  
shower column

**Flat**

piatto doccia Antracite  
Anthracite shower tray



**TEPB43 + TELF**  
angolo\_corner

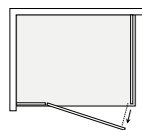

**Danubio**  
colonna doccia  
shower column

**Flat**  
piatto doccia Crema  
Cream shower tray



I dettagli squadrati e cromati e la presenza minimale dei profili ne fanno un prodotto dal design essenziale ma al contempo ricercato. Un box doccia con la porta a battente, per piatti doccia ad angolo o a nicchia.

—  
These squared chrome details and the minimum presence of profiles make this product design essential and researched at the same time. A shower enclosure with a hinged door for corner or niche installation.



# TEPB43

Porta battente\_Hinge doors **H 2007 mm**

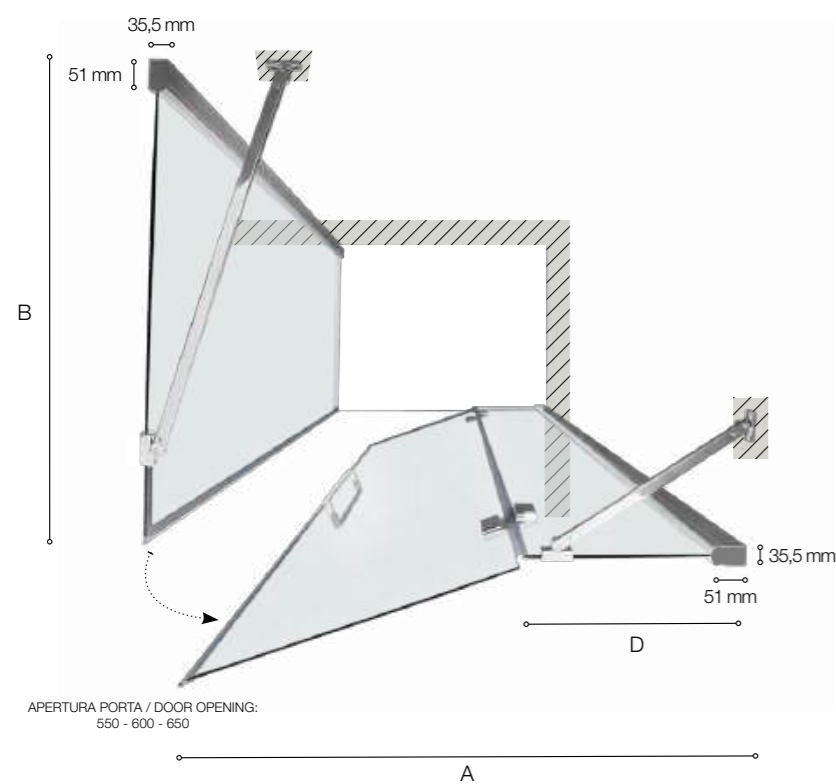

**PORTA ABBINATA A LATO FISSO**  
DOOR MATCHED WITH FIXED PANEL

Specifiche tecniche / Technical specifications			
P/D	H/H	Estensibilità mm	D
mm	mm	Extension mm	mm
850	2007	820 - 835	239
900	2007	870 - 885	239
1000	2007	970 - 985	289
1100	2007	1070 - 1085	389
1200	2007	1170 - 1185	489
1300	2007	1270 - 1285	589
1400	2007	1370 - 1385	689

**DIMENSIONI LATO FISSO (B)**  
FIXED SIDE PANEL SIZE (B)

Specifiche tecniche / Technical specifications			
P/D	H/H	Peso vetro kg	Estensibilità mm
mm	mm	Glass weight kgs	Extension mm
700	2007	22	680 - 700
800	2007	25	770 - 790
900	2007	28	870 - 890
1000	2007	31	970 - 990

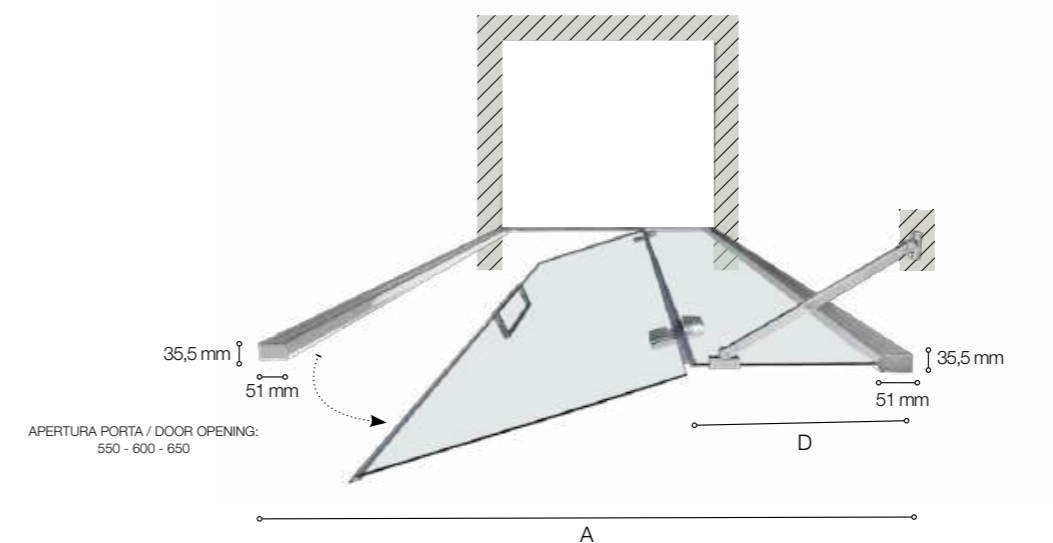

**DIMENSIONI PORTA (A) (NICCHIA) CON PROFILO DI CHIUSURA NTPC01**  
DOOR SIZE (A) (NICHE) WITH CLOSING PROFILE NTPC01

Specifiche tecniche / Technical specifications					
L/W	H/H	Peso vetro kg	Apertura porta	Ingombro porta	Estensibilità mm
mm	mm	Glass weight kgs	Door opening	Clumbed door	Extension mm
850	2007	31	550	607	860 - 895
900	2007	31,5	600	657	910 - 945
1000	2007	32	650	707	1010 - 1045
1100	2007	36	650	707	1110 - 1145
1200	2007	38	650	707	1210 - 1245
1300	2007	45	650	707	1310 - 1345
1400	2007	49	650	707	1410 - 1445

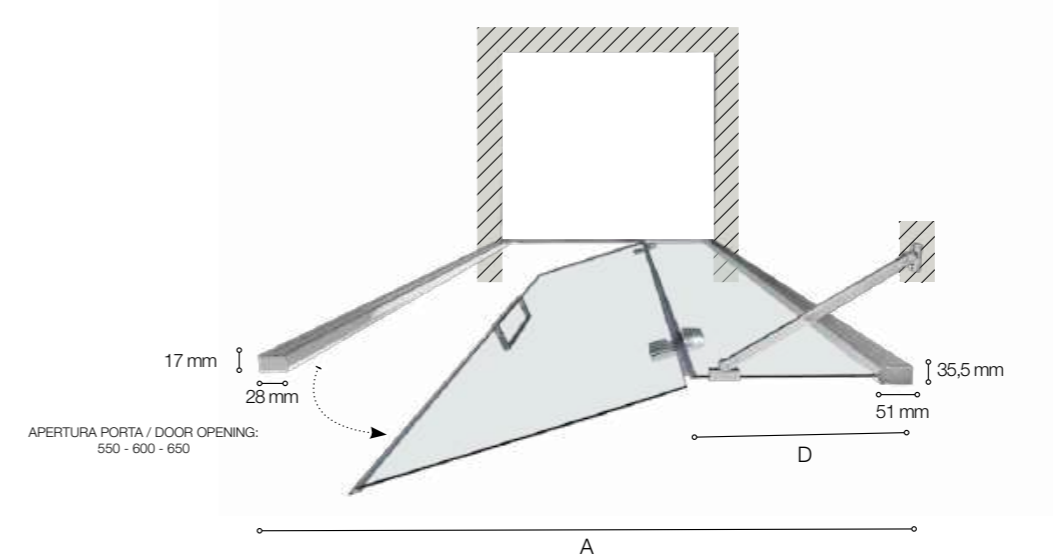
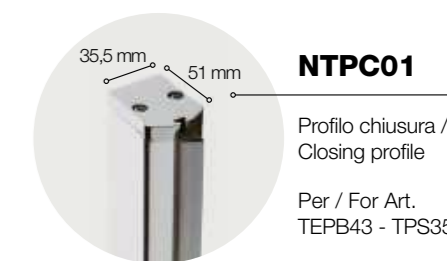

**DIMENSIONI PORTA (A) (NICCHIA) CON PROFILO DI CHIUSURA NTPC03**  
DOOR SIZE (A) (NICHE) WITH CLOSING PROFILE NTPC03

Specifiche tecniche / Technical specifications					
L/W	H/H	Peso vetro kg	Apertura porta	Ingombro porta	Estensibilità mm
mm	mm	Glass weight kgs	Door opening	Clumbed door	Extension mm
850	2007	31	550	607	825 - 845
900	2007	31,5	600	657	875 - 895
1000	2007	32	650	707	975 - 995
1100	2007	36	650	707	1075 - 1095
1200	2007	38	650	707	1175 - 1195
1300	2007	45	650	707	1275 - 1295
1400	2007	49	650	707	1375 - 1395

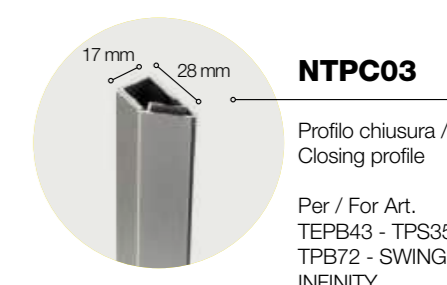

# FPB40

FPB40 risolve tutte le configurazioni della zona doccia nel vostro bagno.

The FPB40 shower enclosure can satisfy all the shower area configurations of your bathroom.

## versioni\_versions

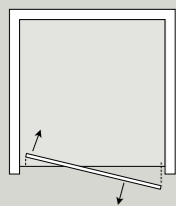

Porta battente  
Versione: Nicchia

Hinge door  
Version: Niche

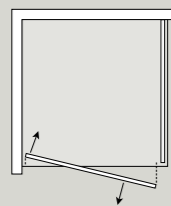

Porta battente  
Versione: Angolo

Hinge door  
Version: Corner

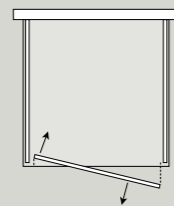

Porta battente  
Versione: Centro parete

Hinge door  
Version: Center wall

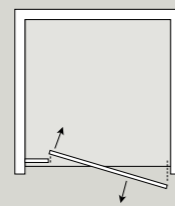

Porta battente  
Versione: Nicchia

Hinge door  
Version: Niche

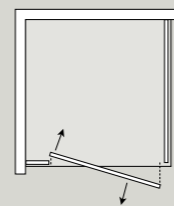

Porta battente  
Versione: Angolo

Hinge door  
Version: Corner

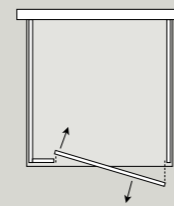

Porta battente  
Versione: Centro parete

Hinge door  
Version: Center wall

## caratteristiche tecniche\_technical characteristics



easy clean

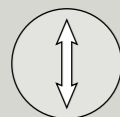

**h 2000 mm**  
altezza  
height

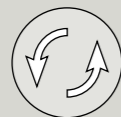

reversibile  
reversible

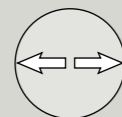

**50 mm**  
regolazione  
adjustment



**6 mm**  
cristallo temperato  
tempered glass

TPAEF11



**+30 mm**  
profilo di allungamento  
adjustable profile

## finiture\_finishes



cromo  
chrome

## cristallo\_glass

Cristallo satinato  
Frosted glass

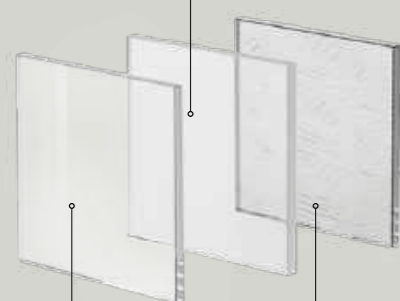

Cristallo trasparente  
Transparent glass

Cristallo Cincillà  
Chinchilla glass



FPB40 + FISSO  
angolo\_corner

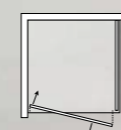

**Senna**  
colonna doccia  
shower column

**Flat**  
piatto doccia Antracite  
Anthracite shower tray



FPB40 + FISSO  
angolo\_corner



**Diana**  
colonna doccia  
shower column

**Flat bordo**  
piatto doccia Bianco  
White shower tray



Le versioni con larghezza 100, 110 e 120 cm presentano un'anta fissa che affianca la porta battente.

The versions with widths of 100, 110, and 120 cm feature a fixed panel that accompanies the hinged door.



FPB40  
nicchia\_niche



**Nettuno**  
colonna doccia  
shower column

**Flat**  
piatto doccia Antracite  
Anthracite shower tray

La struttura cromata e i dettagli tecnici esteticamente minimali la rendono un prodotto adatto a tutti gli stili moderni.

The polished aluminum frame and minimalistic technical details make this enclosure suitable for modern styles.





I dettagli estetici e tecnici conferiscono a questo box doccia originalità e grande versatilità stilistica e di abbinamento.

The aesthetic and technical details give this shower enclosure originality and great stylistic versatility of matching the environment.

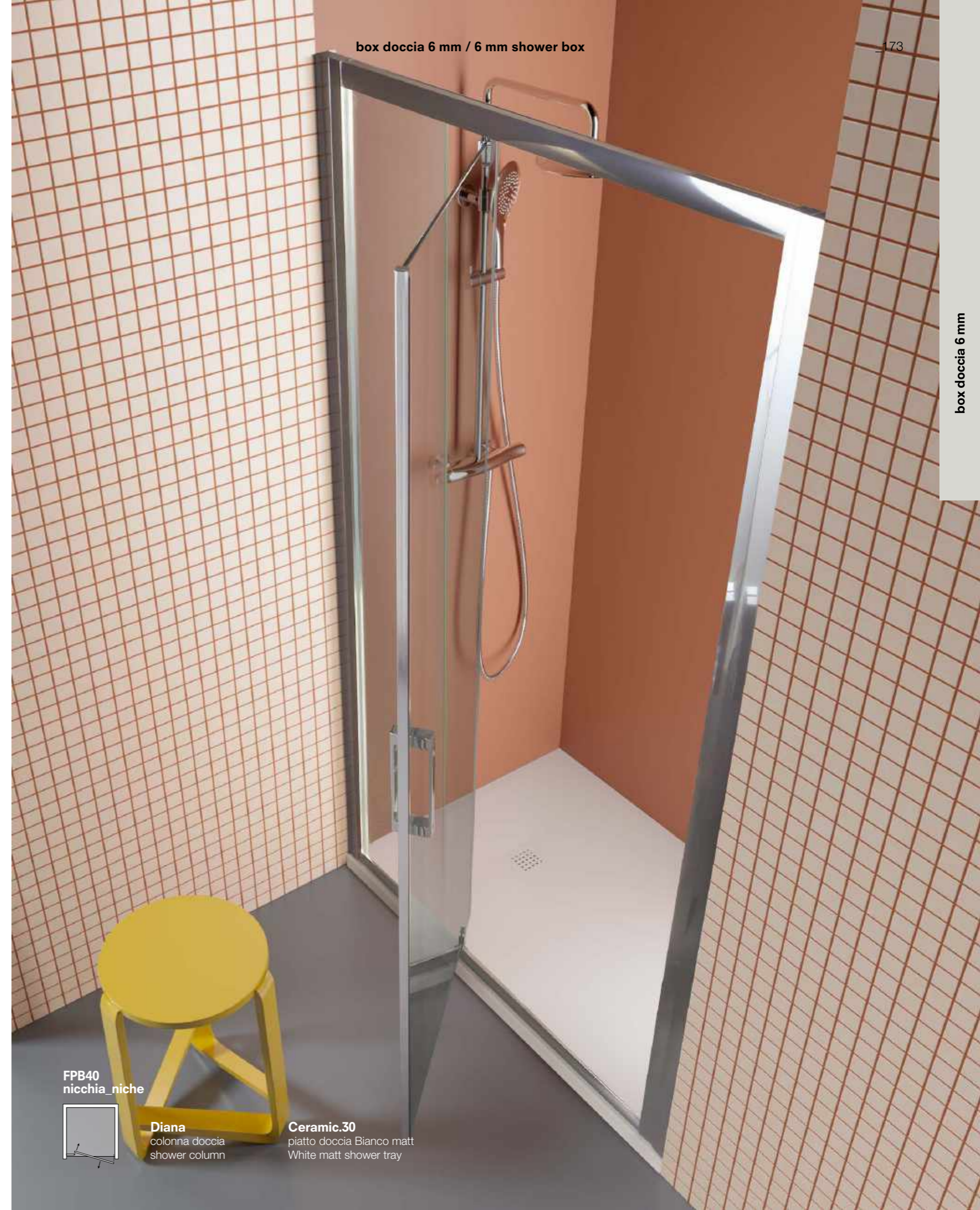

FPB40  
nicchia\_niche



Diana  
colonna doccia  
shower column

Ceramic.30  
piatto doccia Bianco matt  
White matt shower tray





Ad angolo, a nicchia o centro parete offre una soluzione con porta a battente ruotante su una cerniera/perno, offrendo il giusto connubio tra gusto e funzionalità.

Corner, niche or center wall, the FPB40 offers a solution with a hinged rotating door on a special hinge/pivot, offering the correct union between taste and functionality.



**FPB40 + FISSO**  
centro parete\_center wall

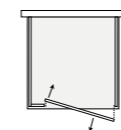

**Nettuno**  
colonna doccia  
shower column

**Flat**  
piatto doccia Bianco  
White shower tray

# FPB40

Porta battente\_Hinge doors **H 2000 mm**

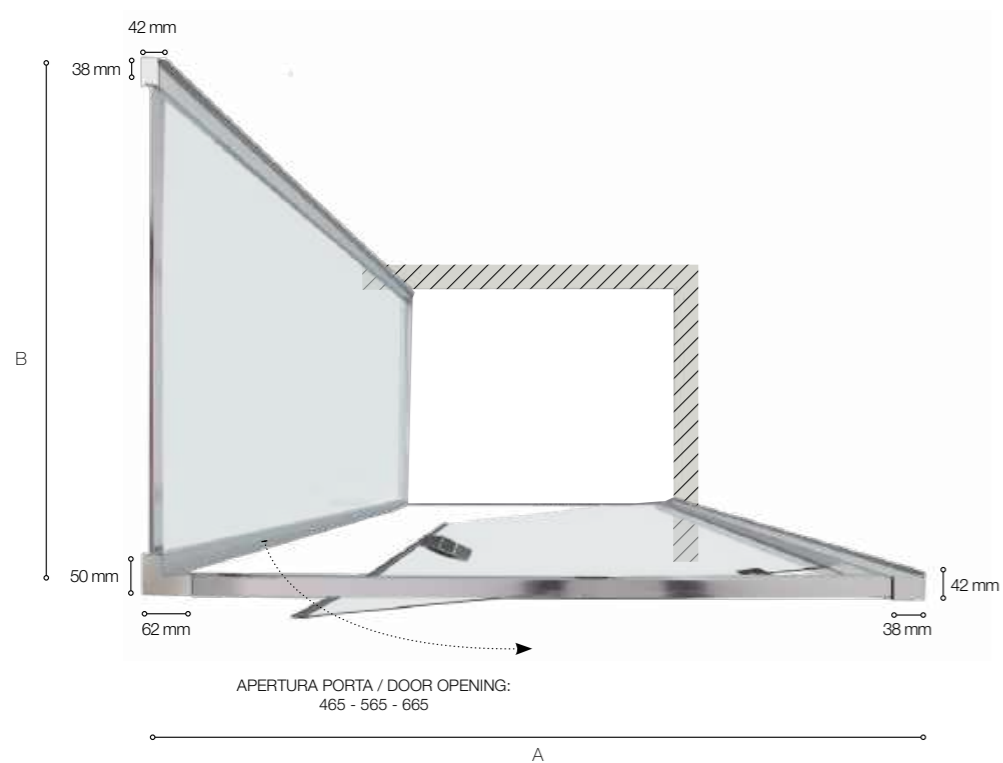

Versione Angolare DX da 90 cm  
Right Corner Version 90 cm

## PORTA ABBINATA A LATO FISSO (A) DOOR MATCHED WITH FIXED PANEL (A)

Specifiche tecniche / Technical specifications		
P/D	H/H	Estensibilità mm
mm	mm	Extension mm
700	2000	662 - 710
800	2000	762 - 810
900	2000	862 - 910

## DIMENSIONI LATO FISSO (B) FIXED SIDE PANEL SIZE (B)

Specifiche tecniche / Technical specifications			
P/D	H/H	Peso vetro kg	Estensibilità mm
mm	mm	Glass weight kgs	Extension mm
650	2000	22	615 - 665
700	2000	24	665 - 715
800	2000	27	765 - 815
900	2000	30	865 - 915
1000	2000	34	965 - 1015

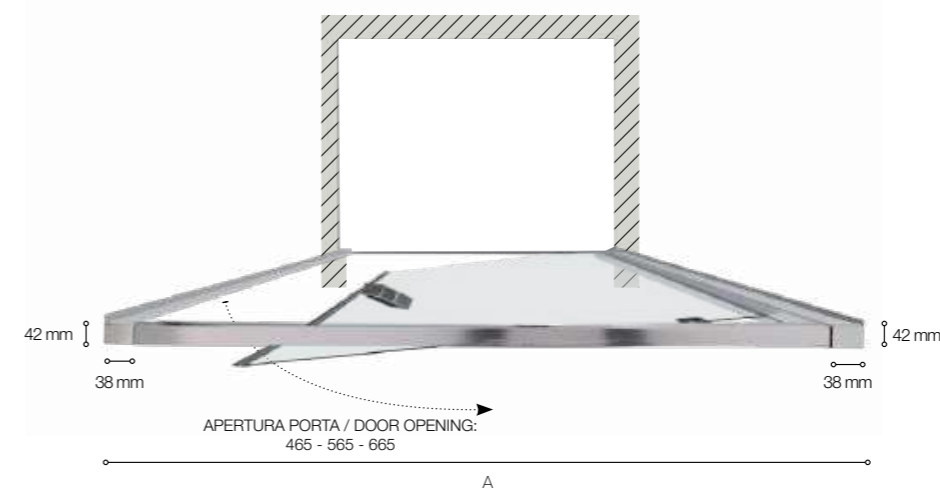

Versione Nicchia  
Niche Version

## DIMENSIONI PORTA (A) (NICCHIA) DOOR SIZES (A) (NICHE)

Specifiche tecniche / Technical specifications				
L/W	H/H	Peso vetro kg	Apertura porta	Estensibilità mm
mm	mm	Glass weight kgs	Door opening	Extension mm
700	2000	24	465	650 - 700
800	2000	28	565	750 - 800
900	2000	30	665	850 - 900

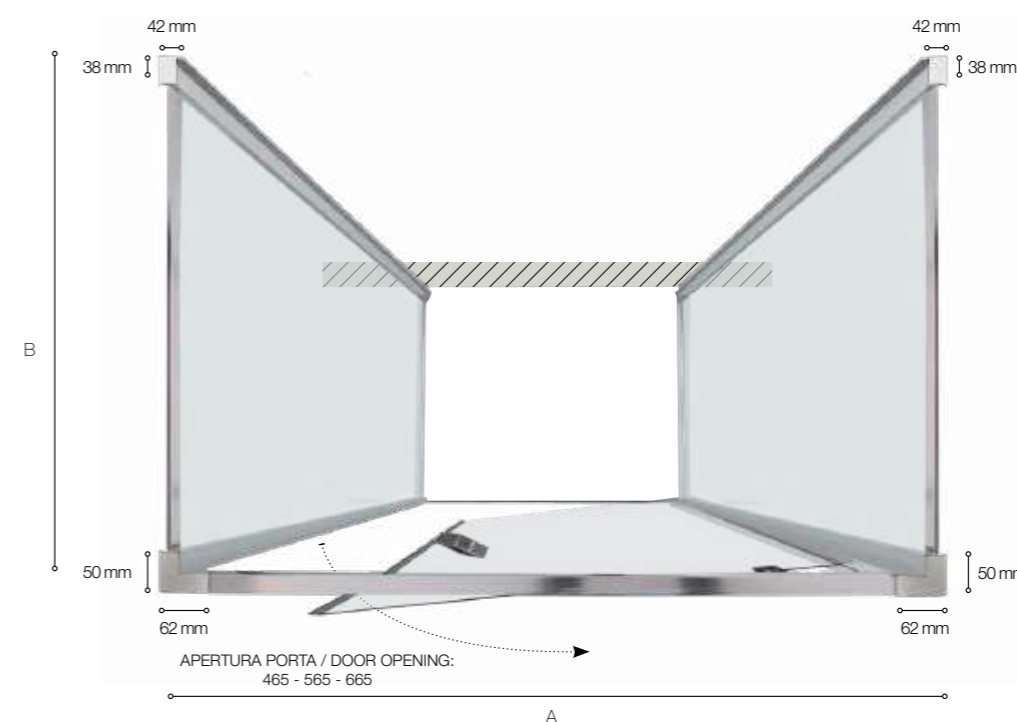

Versione Centro Parete  
Center Wall Version

## PORTA ABBINATA A 2 LATI FISSI DOOR MATCHED WITH 2 FIXED PANELS

Specifiche tecniche / Technical specifications		
P/D	H/H	Estensibilità mm
mm	mm	Extension mm
700	2000	674 - 720
800	2000	774 - 820
900	2000	874 - 920

## DIMENSIONI LATO FISSO (B) FIXED SIDE PANEL SIZE (B)

Specifiche tecniche / Technical specifications			
P/D	H/H	Peso vetro kg	Estensibilità mm
mm	mm	Glass weight kgs	Extension mm
650	2000	22	615 - 665
700	2000	24	665 - 715
800	2000	27	765 - 815
900	2000	30	865 - 915
1000	2000	34	965 - 1015

# FPB40

Porta battente\_Hinge doors **H 2000 mm**

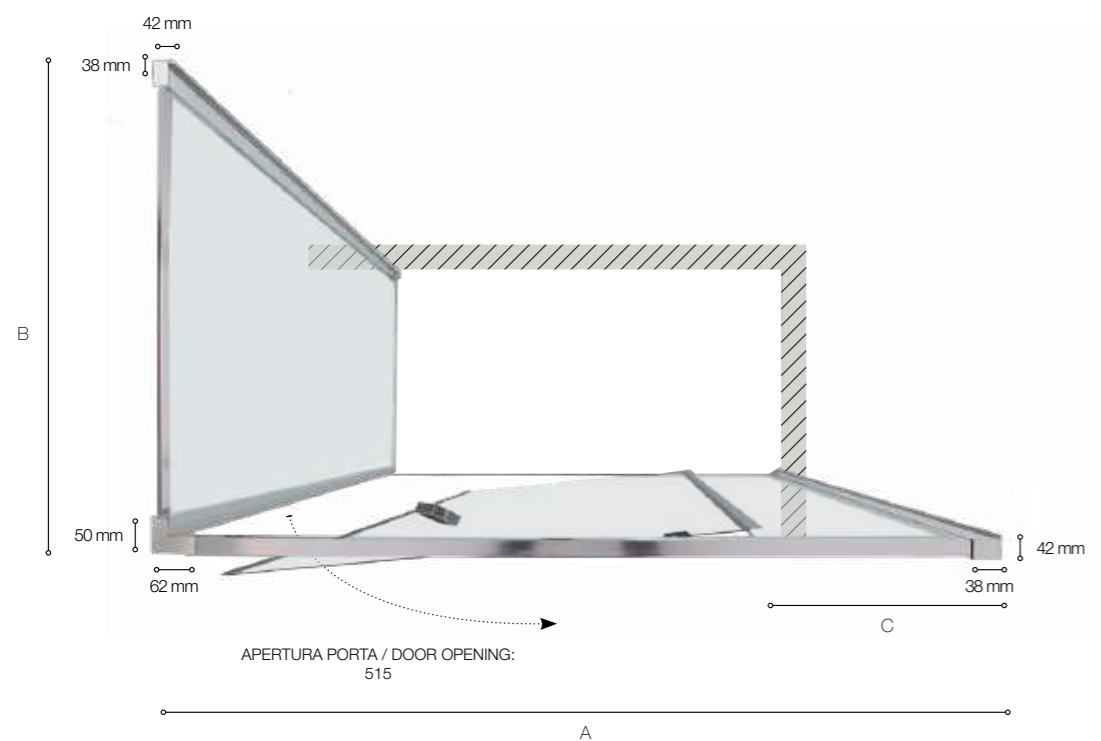

Versione Angolare DX da 120 cm  
Right Corner Version 120 cm

## PORTA ABBINATA A LATO FISSO

DOOR MATCHED WITH FIXED PANEL

Specifiche tecniche / Technical specifications		
P/D	H/H	Estensibilità mm
mm	mm	Extension mm
1000	2000	962 - 1010
1100	2000	1062 - 1110
1200	2000	1162 - 1210

## DIMENSIONI LATO FISSO (B)

FIXED SIDE PANEL SIZE (B)

Specifiche tecniche / Technical specifications			
P/D	H/H	Peso vetro kg	Estensibilità mm
mm	mm	Glass weight kgs	Extension mm
650	2000	22	615 - 665
700	2000	24	665 - 715
800	2000	27	765 - 815
900	2000	30	865 - 915
1000	2000	34	965 - 1015

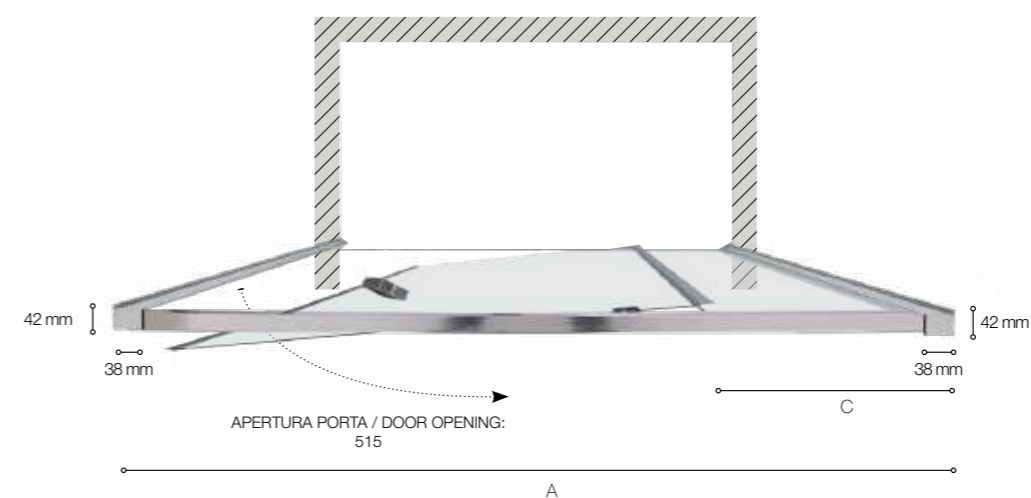

Versione Nicchia  
Niche Version

## DIMENSIONI PORTA (A) (NICCHIA)

DOOR SIZES (A) (NICHE)

Specifiche tecniche / Technical specifications					
L/W	H/H	Peso vetro kg	Apertura porta	Estensibilità mm	C
mm	mm	Glass weight kgs	Door opening	Extension mm	mm
1000	2000	33	515	950 - 1000	260
1100	2000	36	515	1050 - 1100	360
1200	2000	39	515	1150 - 1200	460

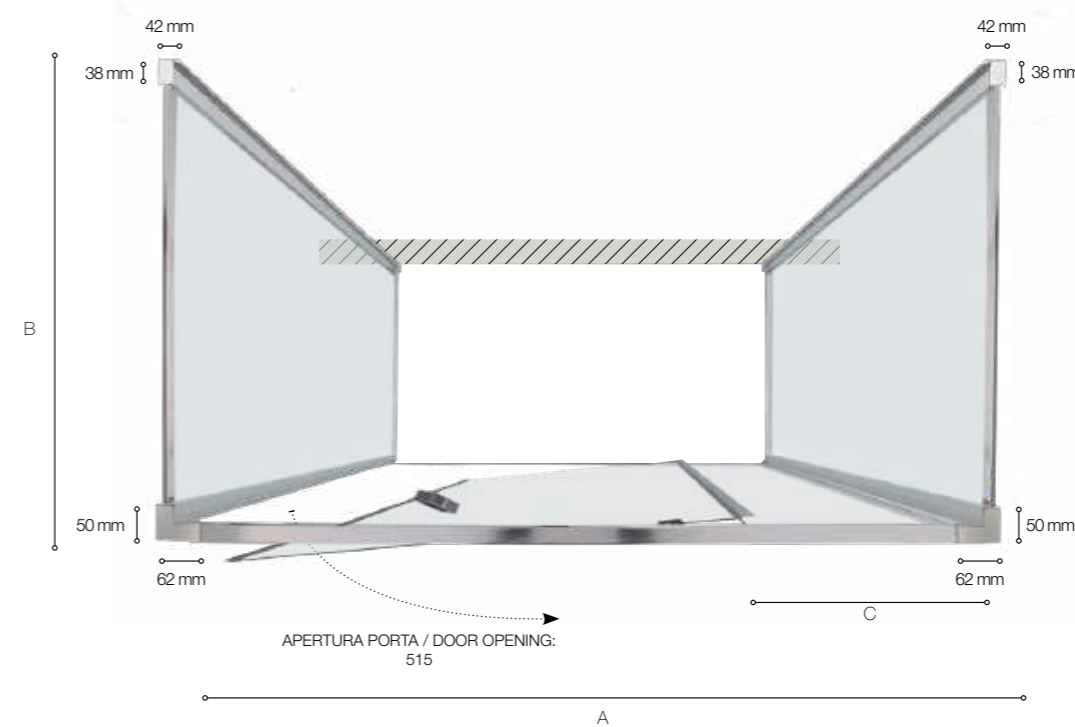

Versione Centro Parete  
Center Wall Version

## PORTA ABBINATA A 2 LATI FISSI

DOOR MATCHED WITH 2 FIXED PANELS

Specifiche tecniche / Technical specifications		
P/D	H/H	Estensibilità mm
mm	mm	Extension mm
1000	2000	974 - 1020
1100	2000	1074 - 1120
1200	2000	1174 - 1220

## DIMENSIONI LATO FISSO (B)

FIXED SIDE PANEL SIZE (B)

Specifiche tecniche / Technical specifications			
P/D	H/H	Peso vetro kg	Estensibilità mm
mm	mm	Glass weight kgs	Extension mm
650	2000	22	615 - 665
700	2000	24	665 - 715
800	2000	27	765 - 815
900	2000	30	865 - 915
1000	2000	34	965 - 1015

# TPB72

Una cabina doccia dalle caratteristiche estetiche e di alta qualità tipiche dei nostri prodotti. Una ricerca nel dettaglio e nelle finitura che rende ogni prodotto originale ed esclusivo.

A shower enclosure with the aesthetic characteristics and the high quality of our products. The product research and finish renders this shower original end exclusive.

## versioni\_versions

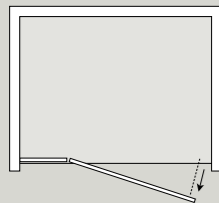

Porta battente  
Versione: Nicchia  
Hinge door  
Version: Niche

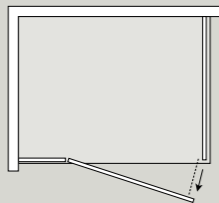

Porta battente  
Versione: Angolo  
Hinge door  
Version: Corner

## caratteristiche tecniche\_technical characteristics



easy clean

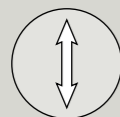

**h 2060 mm**  
altezza  
height

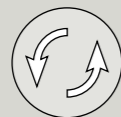

reversibile  
reversible

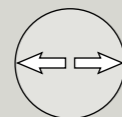

**20 mm**  
regolazione  
adjustment



**6 mm**  
cristallo temperato  
tempered glass

**NTPA05**



**+25 mm**  
profilo di allungamento  
adjustable profile

## finiture\_finishes



cromo  
chrome

## cristallo\_glass



Cristallo trasparente  
Transparent glass

box doccia 6 mm / box doccia 6 mm

\_181



box doccia 6 mm

TBP72 + BLF  
angolo\_corner



Set tondo  
set doccia  
shower set

Flat  
piatto doccia Antracite  
Anthracite shower tray



Una soluzione a battente reversibile incorniciato da profili piatti, agganci e cerniere che sorreggono le lastre di vetro temperato con punti di ancoraggio minimi ma tecnicamente sicuri e stabili.

The reversible hinge doors are framed with flat profiles, supports and hinges which anchor the tempered glass panels in a minimalistic and secure fashion.



**TPB72**  
nicchia\_niche

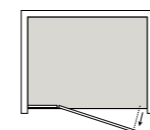

**Pretoria**  
colonna doccia  
shower column

**Flat**  
piatto doccia Bianco  
White shower tray

# TPB72

Porta battente\_Hinge doors **H 2060 mm**

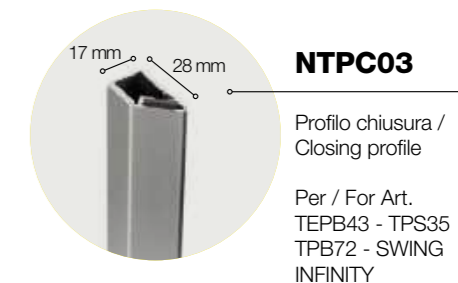
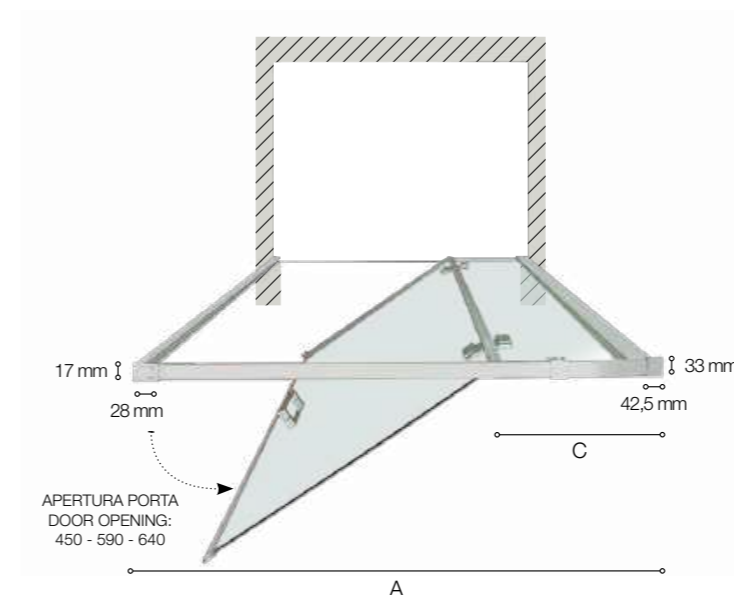
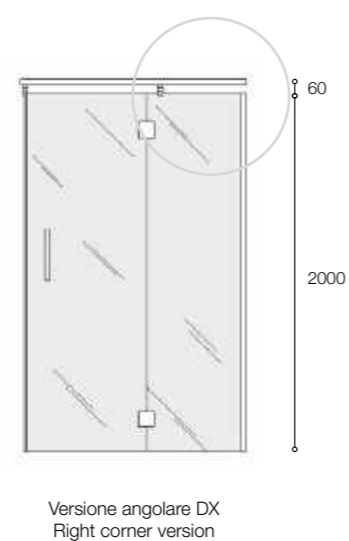
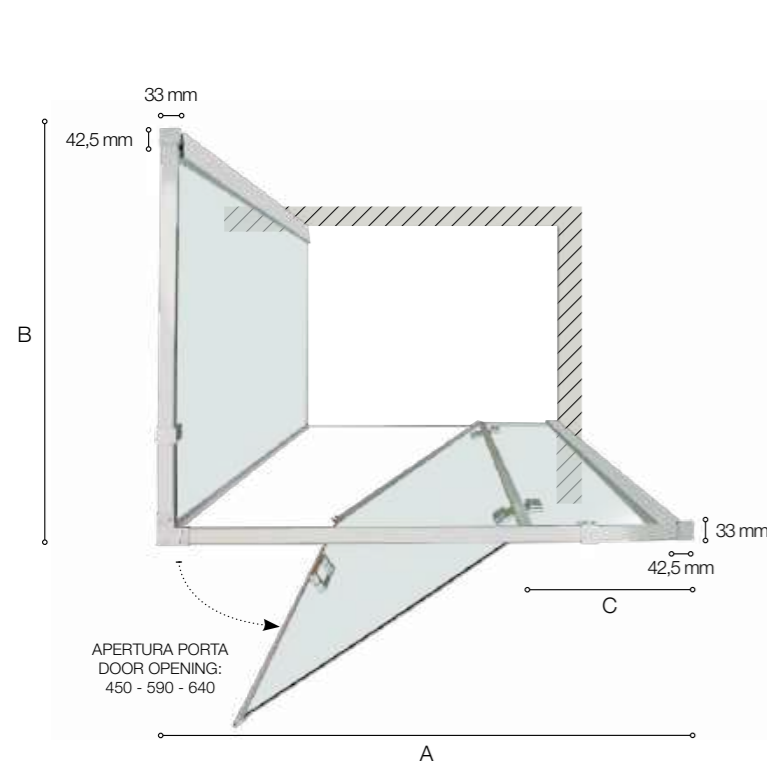

## PORTA ABBINATA A LATO FISSO DOOR MATCHED WITH FIXED PANEL

Specifiche tecniche / Technical specifications				
P/D mm	H/H mm	Peso vetro kg Glass weight kgs	Estensibilità mm Extension mm	Apertura Door opening
700	2060	26	680 - 700	450
800	2060	29	770 - 790	450
900	2060	31	870 - 890	590
1000	2060	34	970 - 990	640
1100	2060	38	1070 - 1090	640
1200	2060	40	1170 - 1190	640
1300	2060	42	1270 - 1290	640
1400	2060	47	1370 - 1390	640

## DIMENSIONI LATO FISSO (B) FIXED SIDE PANEL SIZE (B)

Specifiche tecniche / Technical specifications			
P/D mm	H/H mm	Peso vetro kg Glass weight kgs	Estensibilità mm Extension mm
700	2060	26	680 - 700
800	2060	28	770 - 790
900	2060	30	870 - 890
1000	2060	32	970 - 990

## DIMENSIONI PORTA (A) (NICCHIA) CON PROFILO DI CHIUSURA NTPC03 DOOR SIZE (A) (NICHE) WITH CLOSING PROFILE NTPC03

Specifiche tecniche / Technical specifications						
P/D mm	H/H mm	Peso vetro kg Glass weight kgs	Estensibilità mm Extension mm	Apertura Door opening	Ingombro porta Clumbed door	C mm
700	2060	26	680 - 700	450	456	182
800	2060	29	770 - 790	450	456	272
900	2060	31	870 - 890	590	606	232
1000	2060	34	970 - 990	640	656	282
1100	2060	38	1070 - 1090	640	656	382
1200	2060	40	1170 - 1190	640	656	482
1300	2060	42	1270 - 1290	640	656	582
1400	2060	47	1370 - 1390	640	656	682

# TVB61

TVB61 è perfetta per chi ama la pulizia e la luminosità in un box doccia con pochi profili e deve chiudere un angolo doccia stondato. Le superfici sono sostenute da braccetti di irrigidimento tubolari fissati a parete e piccoli agganci che assicurano stabilità alle lastre curvate in vetro temperato 6 mm.

The TVB61 shower enclosure is perfect for those that love cleanliness and luminosity. This almost frameless design must close a rounded corner shower area. The tempered glass panels are secured by brackets fixed to the wall that offer stability to the 6 mm tempered glass panels.

## versioni\_versions

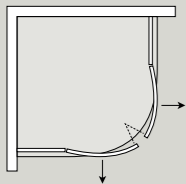

Porta battente  
Versione: Semicircolare  
Hinge door  
Version: Semi-circular

## caratteristiche tecniche\_technical characteristics



easy clean

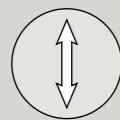

**h 2030 mm**  
altezza  
height

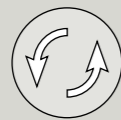

reversibile  
reversible

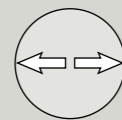

**10 mm**  
regolazione  
adjustment

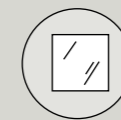

**6 mm**  
cristallo temperato  
tempered glass

NTPA04



**+10 mm**  
profilo di allungamento  
adjustable profile

## finiture\_finishes



cromo  
chrome

## cristallo\_glass



Cristallo trasparente  
Transparent glass



TVB61  
semicircolare semi-circular

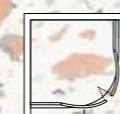

Nettuno  
colonna doccia  
shower column

Flat  
piatto doccia Bianco  
White shower tray



**TVB61**  
semicircolare\_semi-circular

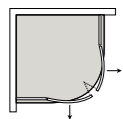

**Nettuno**  
colonna doccia  
shower column

**Flat**  
piatto doccia Bianco  
White shower tray

box doccia 6 mm



# TVB61

Porta battente\_Hinge doors **H 2030 mm**

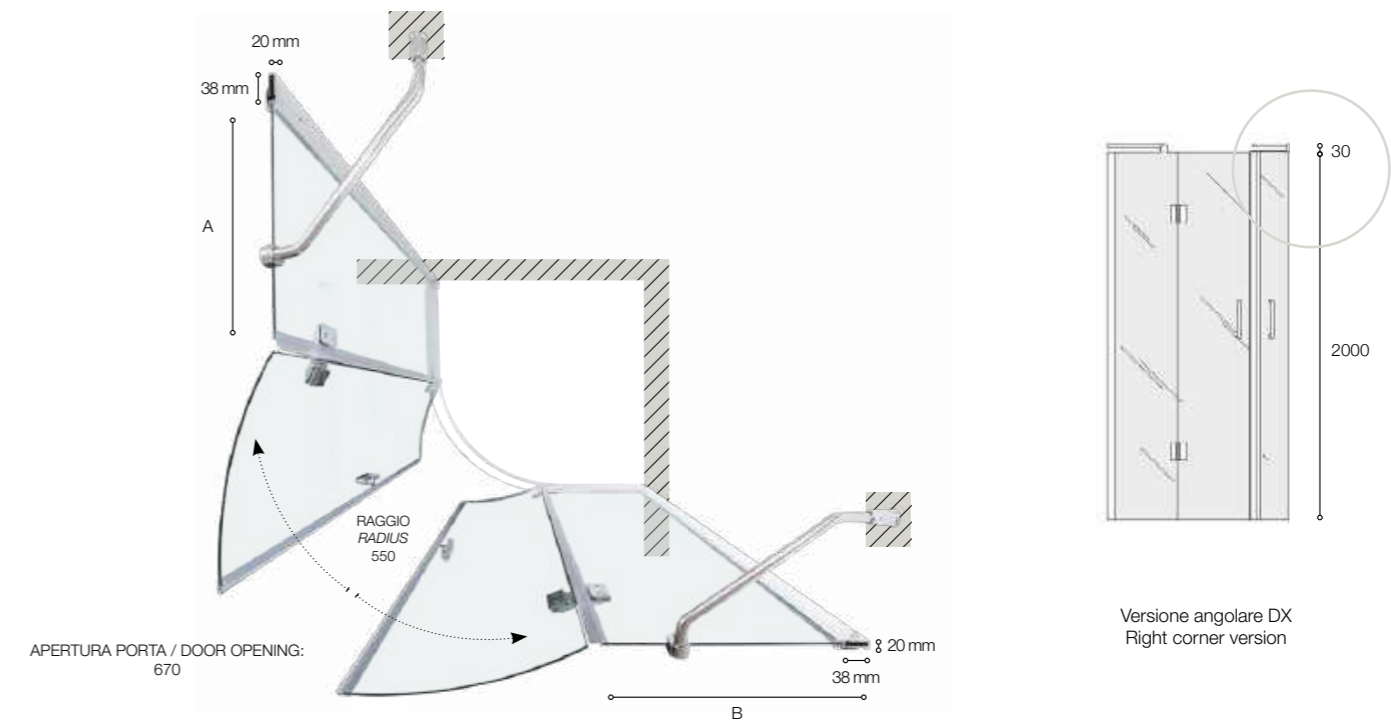

## BOX COMPLETO COMPLETE SHOWER

### Specifiche tecniche / Technical specifications

L/W		P/D		H/H		Estensibilità		A/B	
mm	mm	mm	mm	Peso vetro kg Glass weight kgs	Apertura porta Door opening	L mm W mm	P mm D mm	mm	mm
800	800	2030	2030	47	670	773 - 783	773 - 783	215	215
900	900	2030	2030	52	670	873 - 883	873 - 883	315	315
1000	1000	2030	2030	58	670	973 - 983	973 - 983	415	415

# FPSL60

Apertura totale e bidirezionale per la porta a due ante di FPSL60. Una grande facilità di ingresso e di uscita anche grazie alla doppia maniglia verticale.

The FPSL60 shower enclosure offers total and bi-directional opening of two doors. Great ease of entry and exit, also thanks to the double vertical handles.

## versioni\_versions

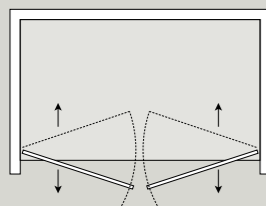

Porta a saloon  
Versione: Nicchia

Saloon door  
Version: Niche

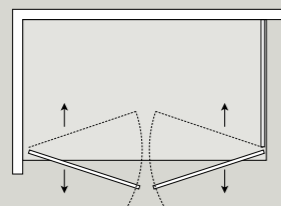

Porta a saloon  
Versione: Angolare

Saloon door  
Version: Corner

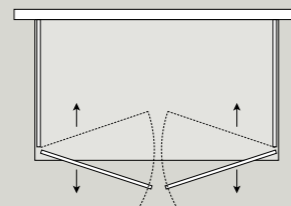

Porta a saloon  
Versione: Centro parete

Saloon door  
Version: Center wall

## caratteristiche tecniche\_technical characteristics



easy clean

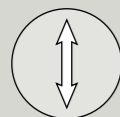

**h 2000 mm**  
altezza  
height

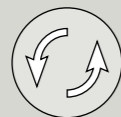

reversibile  
reversible

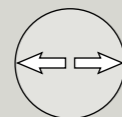

**50 mm**  
regolazione  
adjustment



**6 mm**  
cristallo temperato  
tempered glass

TPAEF11



**+30 mm**  
profilo di allungamento  
adjustable profile

## finiture\_finishes



cromo  
chrome

## cristallo\_glass

Cristallo satinato  
Frosted glass

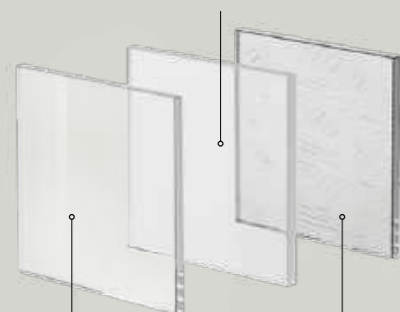

Cristallo trasparente  
Transparent glass

Cristallo Cincillà  
Chinchilla glass



FPSL60 + FISSO  
centro parete\_center wall

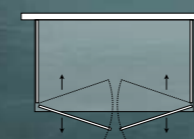

**Nettuno**  
colonna doccia  
shower column

**Flat**  
piatto doccia Bianco  
White shower tray



FPSL60 + FISSO  
angolo\_corner

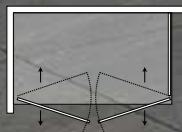

**Diana**  
colonna doccia  
shower column

**Flat**  
piatto doccia Bianco  
White shower tray



box doccia 6 mm



A nicchia, ad angolo o centro parete, il box doccia si presenta con ampie vetrate incorniciate da profili squadrati e importanti su tutti i lati, per gli amanti dei segni solidi e decisi.

Niche, corner or center wall, the FPSL60 has ample glass and important square-shaped profiles around the entire perimeter, for those which appreciate solid and decisive lines.

Le ante sono dotate di sistema UP-DOWN per una chiusura più sicura.

The doors are equipped with a lifting system for safer closing and water containment.



box doccia 6 mm / box doccia 6 mm

FPSL60  
nicchia\_niche

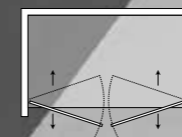

**Gaia**  
colonna doccia  
shower column

**Flat**  
piatto doccia Bianco  
White shower tray

# FPSL60

Porta saloon\_Saloon doors **H 2000 mm**

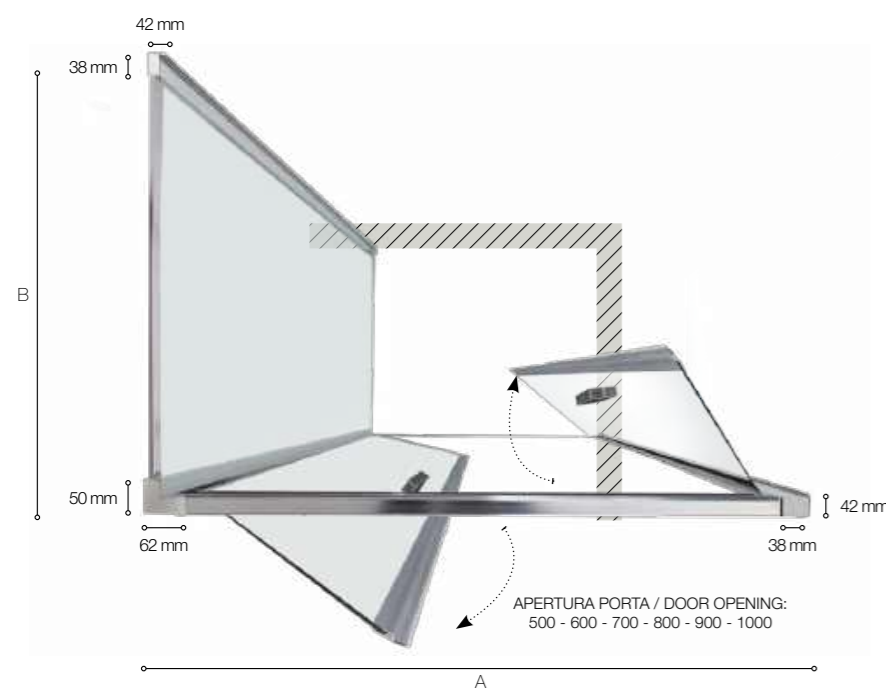

Versione Angolare DX  
Right Corner Version

## PORTA ABBINATA A LATO FISSO

DOOR MATCHED WITH FIXED PANEL

Specifiche tecniche / Technical specifications		
P/D	H/H	Estensibilità mm
mm	mm	Extension mm
700	2000	662 - 710
800	2000	762 - 810
900	2000	862 - 910
1000	2000	962 - 1010
1100	2000	1062 - 1110
1200	2000	1162 - 1210

## DIMENSIONI LATO FISSO (B)

FIXED SIDE PANEL SIZE (B)

Specifiche tecniche / Technical specifications			
P/D	H/H	Peso vetro kg	Estensibilità mm
mm	mm	Glass weight kgs	Extension mm
650	2000	22	615 - 665
700	2000	24	665 - 715
800	2000	27	765 - 815
900	2000	30	865 - 915
1000	2000	34	965 - 1015

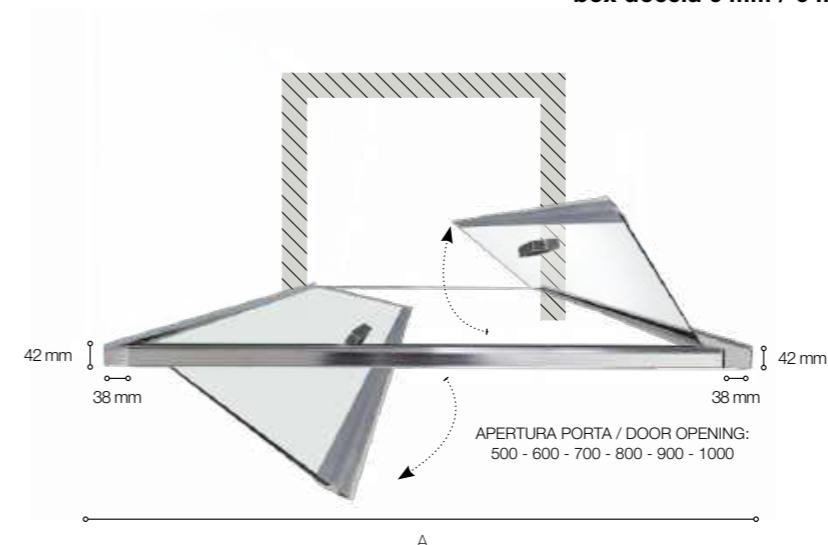

Versione Nicchia  
Niche Version

## DIMENSIONI PORTA (A) (NICCHIA)

DOOR SIZES (A) (NICHE)

Specifiche tecniche / Technical specifications				
L/W	H/H	Peso vetro kg	Apertura porta	Estensibilità mm
		Glass weight kgs	Door opening	Extension mm
700	2000	26	500	650 - 700
800	2000	28	600	750 - 800
900	2000	33	700	850 - 900
1000	2000	36	800	950 - 1000
1100	2000	40	900	1050 - 1100
1200	2000	44	1000	1150 - 1200

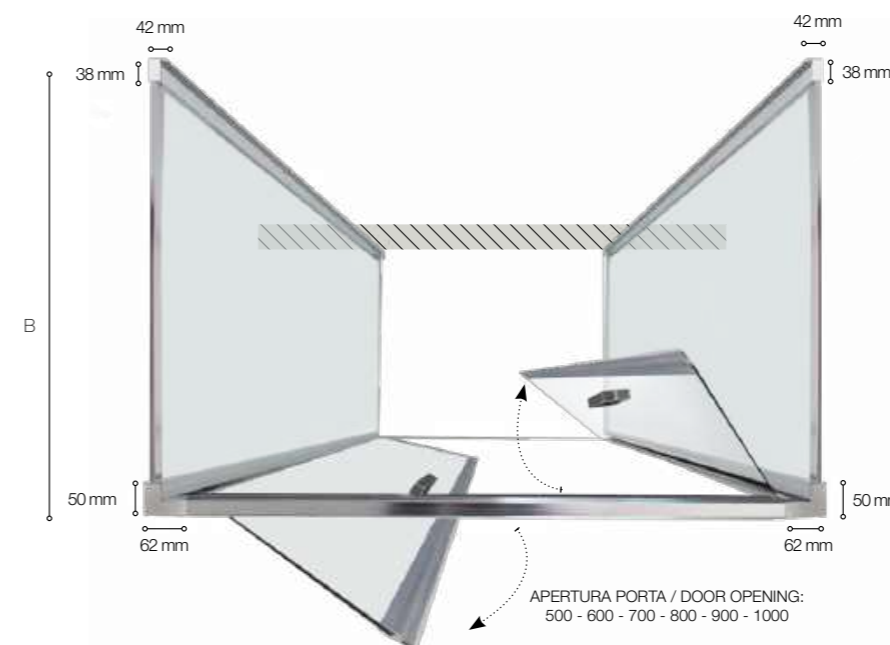

Versione Centro Parete  
Center Wall Version

## PORTA ABBINATA A 2 LATI FISSI

DOOR MATCHED WITH 2 FIXED PANELS

Specifiche tecniche / Technical specifications		
P/D	H/H	Estensibilità mm
mm	mm	Extension mm
700	2000	674 - 720
800	2000	774 - 820
900	2000	874 - 920
1000	2000	974 - 1020
1100	2000	1074 - 1120
1200	2000	1174 - 1220

## DIMENSIONI LATO FISSO (B)

FIXED SIDE PANEL SIZE (B)

Specifiche tecniche / Technical specifications			
P/D	H/H	Peso vetro kg	Estensibilità mm
mm	mm	Glass weight kgs	Extension mm
650	2000	22	615 - 665
700	2000	24	665 - 715
800	2000	27	765 - 815
900	2000	30	865 - 915
1000	2000	34	965 - 1015

# NSALOON

## s/profilo

La SALOON SENZA PROFILI si inserisce nell'ambiente bagno creando una superficie libera, pulita, disegnata esclusivamente dagli elementi fissi che la compongono e dotata della speciale apertura bidirezionale.

The SALOON WITHOUT PROFILES fits in the bathroom creating a free surface, clean, designed only by the fixed elements that compose it and equipped with a special bidirectional opening..

### versioni\_versions

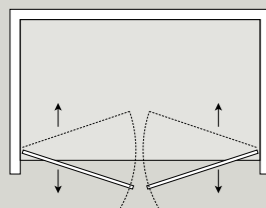

Porta a saloon  
Versione: Nicchia

Saloon door  
Version: Niche

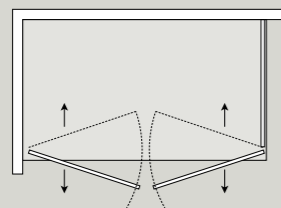

Porta a saloon  
Versione: Angolare

Saloon door  
Version: Corner

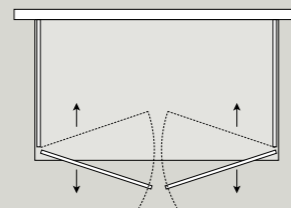

Porta a saloon  
Versione: Centro parete

Saloon door  
Version: Center wall

### caratteristiche tecniche\_technical characteristics



easy clean

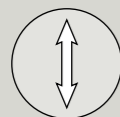

**h 2000 mm**  
altezza  
height

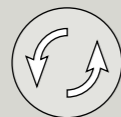

reversibile  
reversible

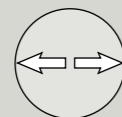

**50 mm**  
regolazione  
adjustment



**6 mm**  
cristallo temperato  
tempered glass

TPA12



**+30 mm**  
profilo di allungamento  
adjustable profile

### finiture\_finishes



cromo  
chrome

### cristallo\_glass



Cristallo trasparente  
Transparent glass

box doccia 6 mm / 6 mm shower box



box doccia 6 mm

NSALOON s/profilo  
nicchia niche

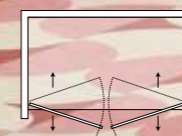

**Diana**  
colonna doccia  
shower column

**Flat**  
piatto doccia Bianco  
White shower tray



NSALOON s/profilo + SALFIS  
centro parete\_center wall

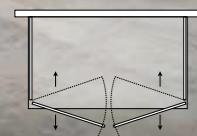

**Sirena**  
colonna doccia  
shower column

**Flat bordo**  
piatto doccia Bianco  
White shower tray



Le ante consentono un'apertura bidirezionale estremamente comoda per ingresso e uscita dal box doccia.

The doors allow for a highly convenient bidirectional opening for both entry and exit from the shower enclosure.



NSALOOON s/profili + SALFIS  
angolo\_corner

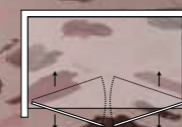

Tritone  
colonna doccia  
shower column

Flat bordo  
piatto doccia Bianco  
White shower tray



# NSALOON s/profilo

Porta a saloon\_Saloon door H 2000 mm

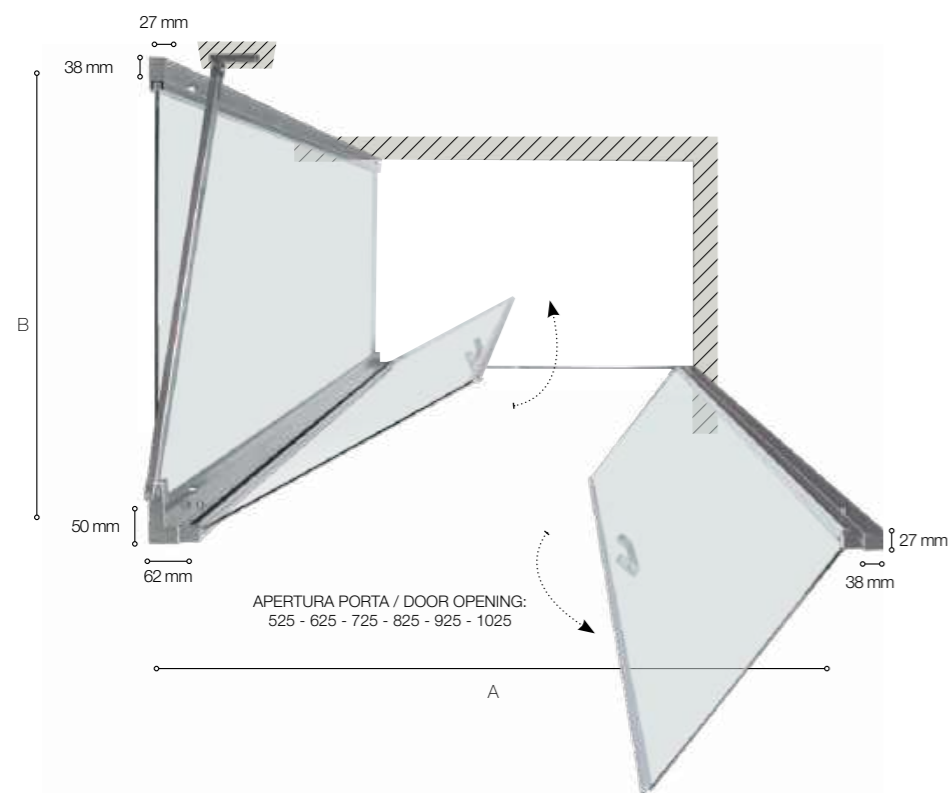

Versione Angolare DX  
Right Corner Version

**PORTA ABBINATA A LATO FISSO**  
DOOR MATCHED WITH FIXED PANEL

Specifiche tecniche / Technical specifications		
P/D	H/H	Estensibilità mm
mm	mm	Extension mm
700	2000	662 - 710
800	2000	762 - 810
900	2000	862 - 910
1000	2000	962 - 1010
1100	2000	1062 - 1110
1200	2000	1162 - 1210

**DIMENSIONI LATO FISSO (B)**  
FIXED SIDE PANEL SIZE (B)

Specifiche tecniche / Technical specifications			
P/D	H/H	Peso vetro kg	Estensibilità mm
mm	mm	Glass weight kgs	Extension mm
700	2030	25	665 - 715
800	2030	28	765 - 815
900	2030	31	865 - 915
1000	2030	34	965 - 1015

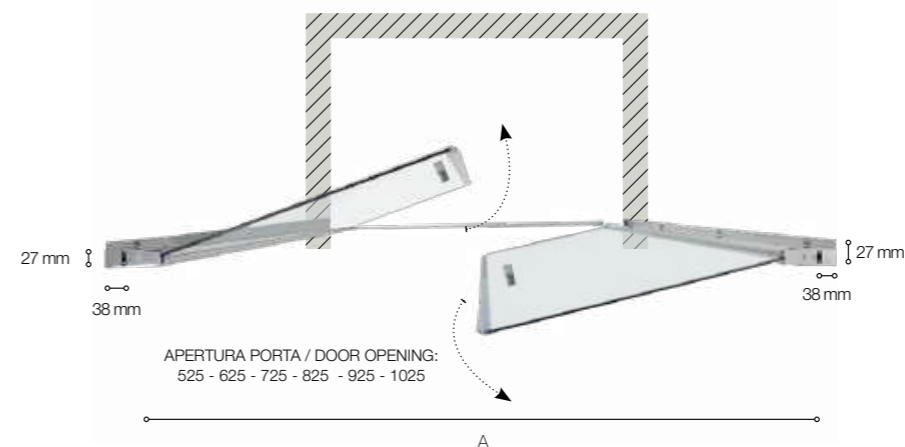

Versione Nicchia  
Niche Version

**DIMENSIONI PORTA (A) (NICCHIA)**  
DOOR SIZES (A) (NICHE)

Specifiche tecniche / Technical specifications				
L/W	H/H	Peso vetro kg	Apertura porta	Estensibilità mm
mm	mm	Glass weight kgs	Door opening	Extension mm
700	2000	26	525	650 - 700
800	2000	32	625	750 - 800
900	2000	34	725	850 - 900
1000	2000	35	825	950 - 1000
1100	2000	38	925	1050 - 1100
1200	2000	41	1025	1150 - 1200

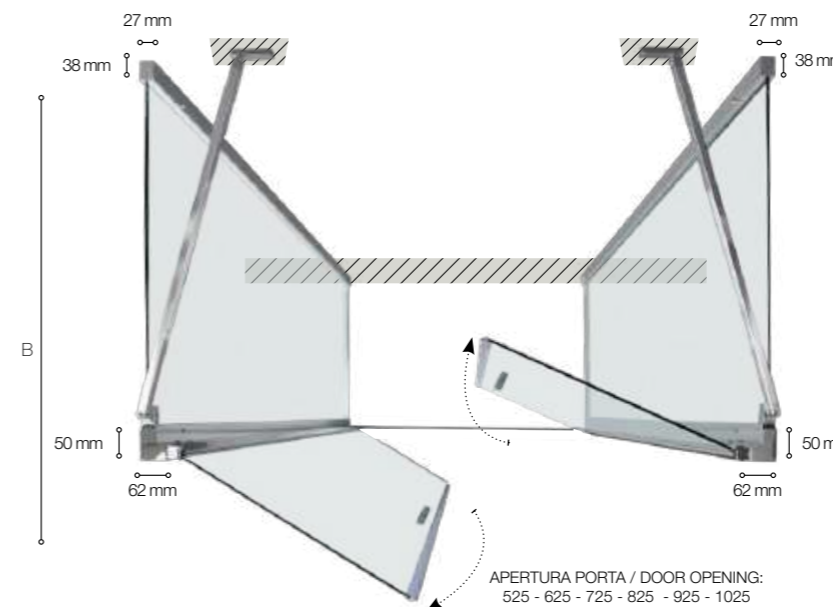

Versione Centro Parete  
Center Wall Version

**PORTA ABBINATA A 2 LATI FISSI**  
DOOR MATCHED WITH 2 FIXED PANELS

Specifiche tecniche / Technical specifications		
P/D	H/H	Estensibilità mm
mm	mm	Extension mm
700	2000	674 - 720
800	2000	774 - 820
900	2000	874 - 920
1000	2000	974 - 1020
1100	2000	1074 - 1120
1200	2000	1174 - 1220

**DIMENSIONI LATO FISSO (B)**  
FIXED SIDE PANEL SIZE (B)

Specifiche tecniche / Technical specifications			
P/D	H/H	Peso vetro kg	Estensibilità mm
mm	mm	Glass weight kgs	Extension mm
700	2030	25	665 - 715
800	2030	28	765 - 815
900	2030	31	865 - 915
1000	2030	34	965 - 1015

# FPS30

Con il box doccia FPS30 si ha la possibilità di scegliere il senso interno-esterno o esterno-interno della porta a soffietto di ingresso per una completa sicurezza.

With the FPS30 shower enclosure it is possible to choose between the internal-external opening or the external-internal opening direction of the bi-fold door for complete safety.

## versioni\_versions

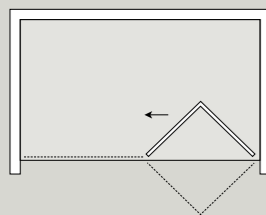

Porta a soffietto  
Versione: Nicchia

Folding door  
Version: Niche

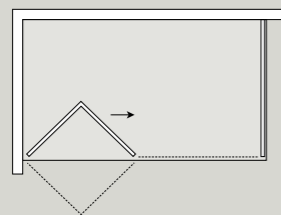

Porta a soffietto  
Versione: Angolare

Folding door  
Version: Corner

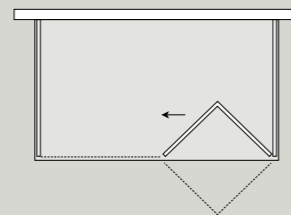

Porta a soffietto  
Versione: Centro parete

Folding door  
Version: Center wall

## caratteristiche tecniche\_technical characteristics



easy clean

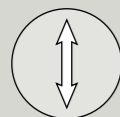

**h 2000 mm**  
altezza  
height

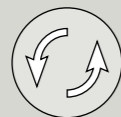

reversibile  
reversible

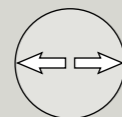

**50 mm**  
regolazione  
adjustment



**6 mm**  
cristallo temperato  
tempered glass

TPAEF11



**+30 mm**  
profilo di allungamento  
adjustable profile



antipanico  
antipanic

## finiture\_finishes



cromo  
chrome

## cristallo\_glass

Cristallo satinato  
Frosted glass



Cristallo trasparente  
Transparent glass

Cristallo Cincillà  
Chinchilla glass

box doccia 6 mm / box doccia 6 mm



box doccia 6 mm

FPS30 + FISSO  
angolo\_corner

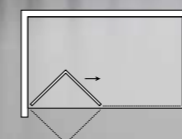

**Nettuno**  
colonna doccia  
shower column

**Flat**  
piatto doccia Bianco  
White shower tray



**FPS30 + FISSO**  
centro parete\_center wall

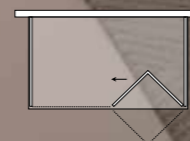

**Gaia**  
colonna doccia  
shower column

**Flat bordo**  
piatto doccia Bianco  
White shower tray



**FPS30**  
nicchia\_niche



**Danubio**  
colonna doccia  
shower column

**Flat**  
piatto doccia Bianco  
White shower tray



La cerniera altamente tecnica permette con grande facilità e velocità la duplice direzione di apertura e chiusura dell'anta pieghevole in vetro temperato 6 mm.

The highly technical hinge permits double opening and closing directions of the 6 mm tempered glass folding door with great ease and speed.



# FPS30

Porta a soffietto\_Folding door **H 2000 mm**

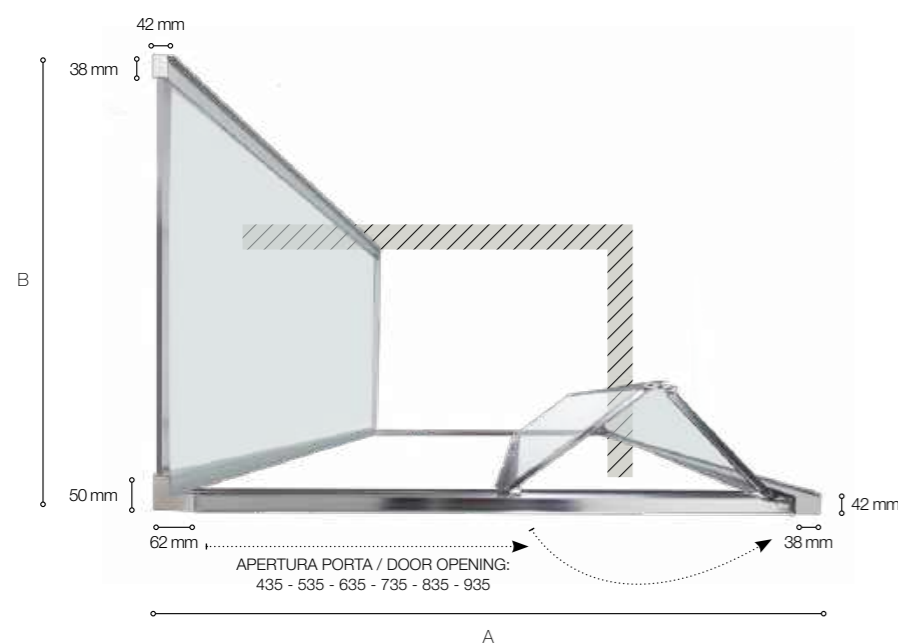

Versione Angolare DX  
Right Corner Version

## PORTA ABBINATA A LATO FISSO

DOOR MATCHED WITH FIXED PANEL

Specifiche tecniche / Technical specifications		
P/D	H/H	Estensibilità mm
mm	mm	Extension mm
700	2000	662 - 710
800	2000	762 - 810
900	2000	862 - 910
1000	2000	962 - 1010
1100	2000	1062 - 1110
1200	2000	1162 - 1210

## DIMENSIONI LATO FISSO (B)

FIXED SIDE PANEL SIZE (B)

Specifiche tecniche / Technical specifications			
P/D	H/H	Peso vetro kg	Estensibilità mm
mm	mm	Glass weight kgs	Extension mm
650	2000	22	615 - 665
700	2000	24	665 - 715
800	2000	27	765 - 815
900	2000	30	865 - 915
1000	2000	34	965 - 1015

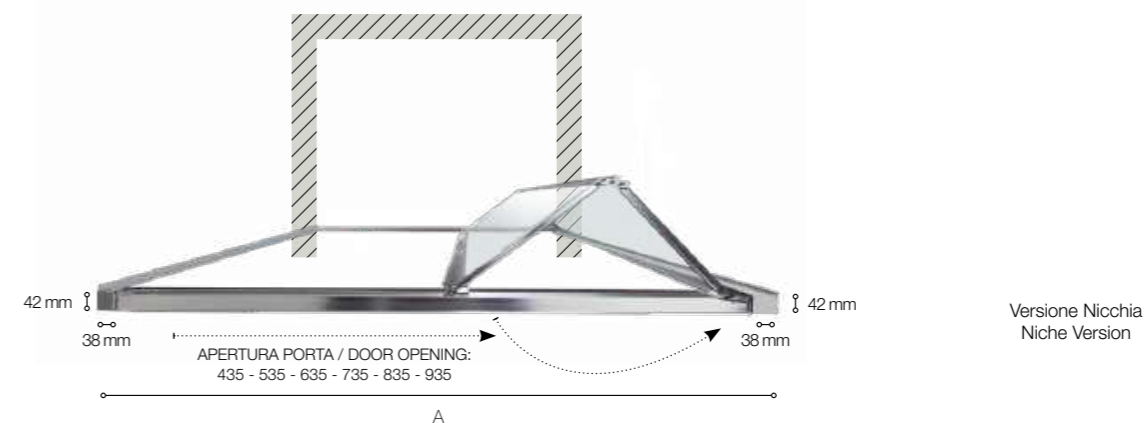

Versione Nicchia  
Niche Version

## DIMENSIONI PORTA (A) (NICCHIA)

DOOR SIZES (A) (NICHE)

Specifiche tecniche / Technical specifications					
L/W	H/H	Peso vetro kg	Apertura porta	Ingombro porta	Estensibilità mm
		Glass weight kgs	Door opening	Clumbed door	Extension mm
700	2000	26	435	280	650 - 700
800	2000	29	535	330	750 - 800
900	2000	32	635	380	850 - 900
1000	2000	35	735	430	950 - 1000
1100	2000	38	835	480	1050 - 1100
1200	2000	41	935	530	1150 - 1200

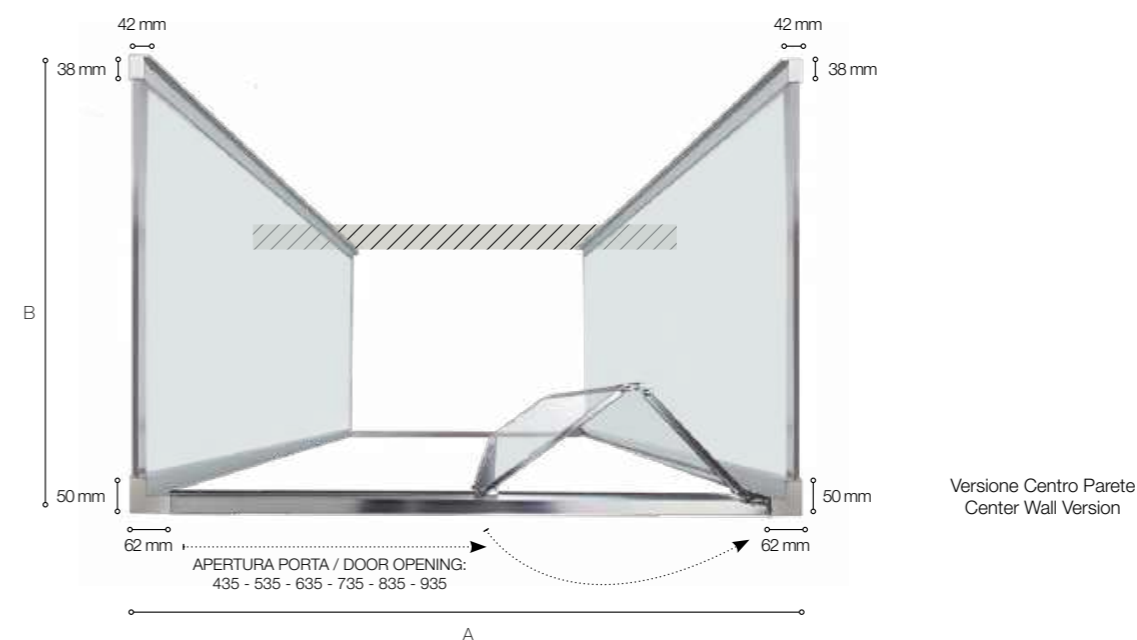

Versione Centro Parete  
Center Wall Version

## PORTA ABBINATA A 2 LATI FISSI

DOOR MATCHED WITH 2 FIXED PANELS

Specifiche tecniche / Technical specifications		
P/D	H/H	Estensibilità mm
mm	mm	Extension mm
700	2000	674 - 720
800	2000	774 - 820
900	2000	874 - 920
1000	2000	974 - 1020
1100	2000	1074 - 1120
1200	2000	1174 - 1220

## DIMENSIONI LATO FISSO (B)

FIXED SIDE PANEL SIZE (B)

Specifiche tecniche / Technical specifications			
P/D	H/H	Peso vetro kg	Estensibilità mm
mm	mm	Glass weight kgs	Extension mm
650	2000	22	615 - 665
700	2000	24	665 - 715
800	2000	27	765 - 815
900	2000	30	865 - 915
1000	2000	34	965 - 1015

# TPS35

Design estremamente minimale e cerniere innovative in ottone cromato permettono al box doccia TPS35 un'apertura a soffietto risolvendo i problemi di ingombro.

Extremely minimalistic design and innovative chromed brass hinges that allow in fold opening, the TPS35 shower enclosure resolves space issues.

## versioni\_versions

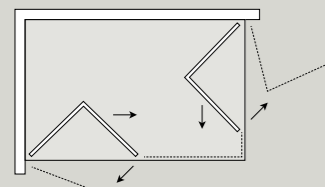

Porta a soffietto  
Versione: Angolare doppia anta

Folding door  
Version: Corner with double door

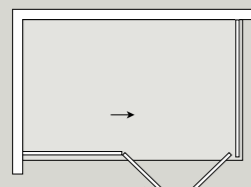

Porta a soffietto  
Versione: Angolare

Folding door  
Version: Corner

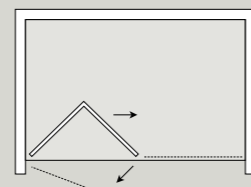

Porta a soffietto  
Versione: Nicchia

Folding door  
Version: Niche

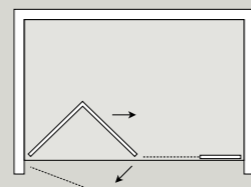

Porta a soffietto  
Versione: Nicchia

Folding door  
Version: Niche

## caratteristiche tecniche\_technical characteristics



easy clean

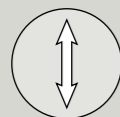

**h 2000 mm**  
altezza  
height

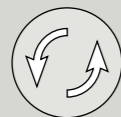

reversibile  
reversible

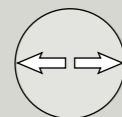

**20 mm**  
regolazione  
adjustment



**6 mm**  
cristallo temperato  
tempered glass

**NTPA01**



**+30 mm**  
profilo di allungamento  
adjustable profile

## finiture\_finishes



cromo  
chrome

## cristallo\_glass

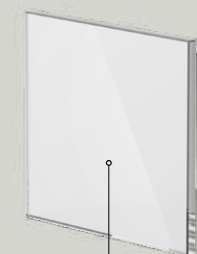

Cristallo trasparente  
Transparent glass

box doccia 6 mm / 6 mm shower box

\_217



box doccia 6 mm

## TPS35 angolo doppia anta\_corner with double door

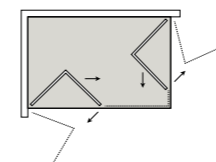

**Sirena**  
colonna doccia  
shower column

**Acrylic H3**  
piatto doccia Bianco  
White shower tray



box doccia 6 mm

Con il box doccia TPS35 si ha la possibilità di scegliere il senso interno-esterno o esterno-interno della porta a soffietto di ingresso per una completa sicurezza.

With the TPS35 shower enclosure it is possible to choose the opening direction of the in fold door; internal-external or external-internal, enhancing safety.





Si ha una totale luce di passaggio con la possibilità di decidere la larghezza delle ante e di conseguenza la rientranza del vetro quando la porta è aperta.

Total passing of light and the possibility to choose the width of the doors and, as a result, the glass door recess when the door is opened.



TPS35  
nicchia\_niche

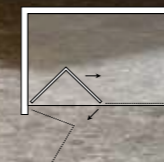

Sirena  
colonna doccia  
shower column

Ceramic.30  
piatto doccia Bianco matt  
White matt shower tray





**TPS35 + TELF IN LINEA**  
nicchia\_niche

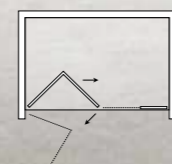

**Pretoria**  
colonna doccia  
shower column

**Flat**  
piatto doccia Bianco  
White shower tray

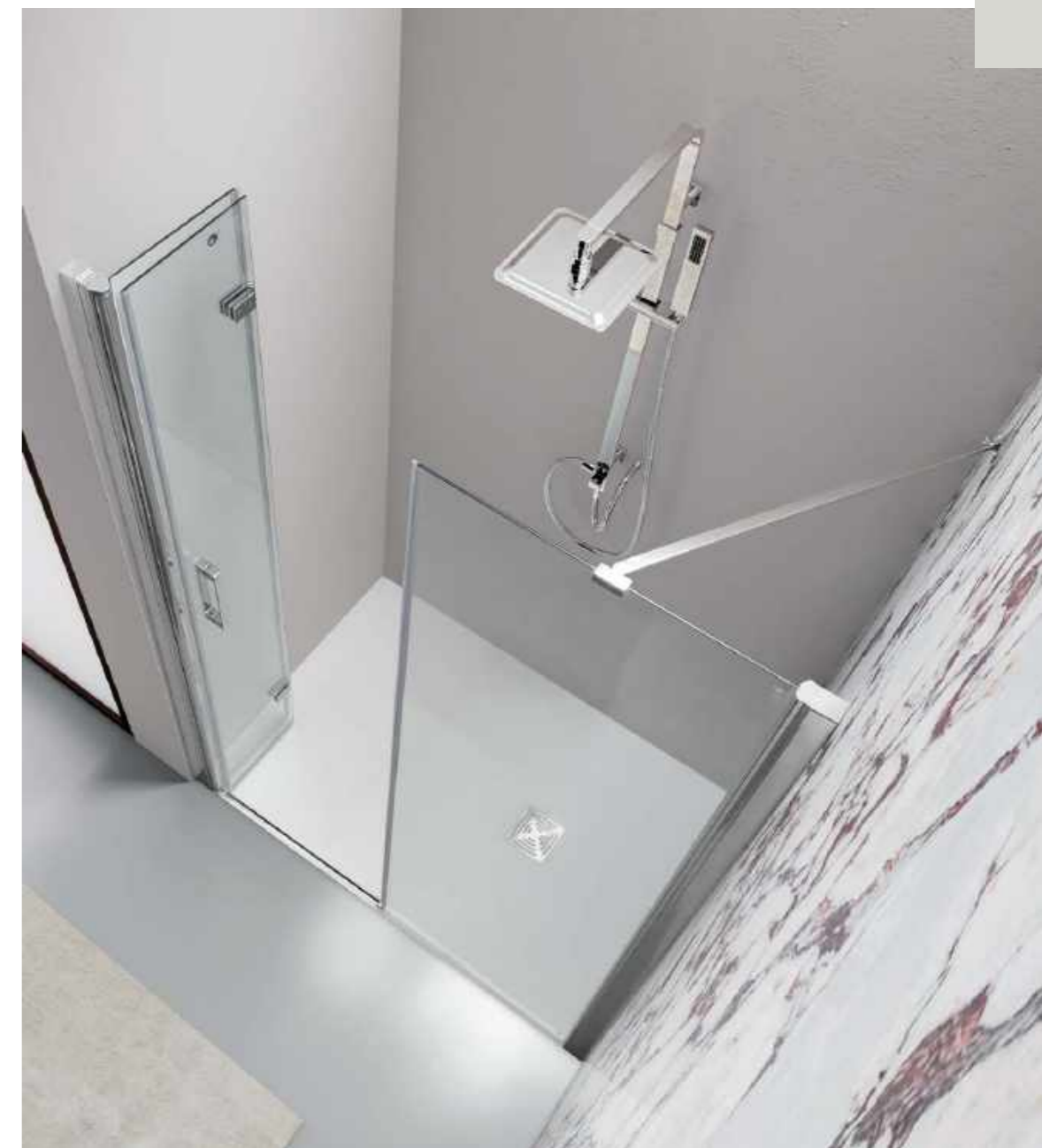



TPS35 + TELF  
angolo\_corner

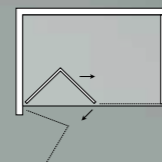

**Nettuno**  
colonna doccia  
shower column

**Flat**  
piatto doccia Bianco  
White shower tray



La porta a soffietto del box TPS35 si apre sia verso l'interno che verso l'esterno, aumentando il comfort nell'uso del box doccia. Ne risulta una migliore gestione dello spazio, indipendentemente dalla configurazione del box prescelta.

The TPS35 box in-fold door opens both inwards and outwards, increasing the comfort in using the shower enclosure. This results in a better space management, regardless of the chosen configuration of the box.

# TPS35

Porta a soffietto\_folding door **H 2000 mm**

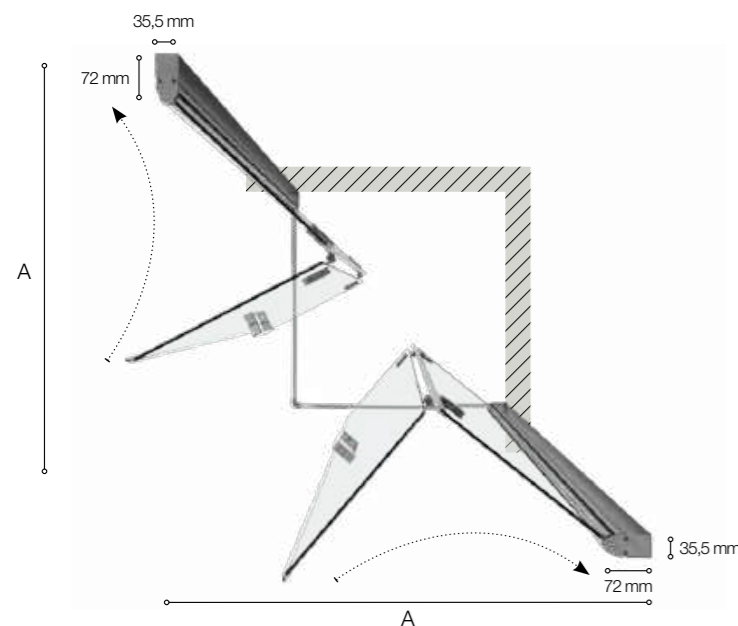

Versione con doppia porta  
Version with double doors

**DIMENSIONI PORTA (A)**  
DOOR SIZES (A)

Specifiche tecniche / Technical specifications				
L/W	H/H	Peso vetro kg	Apertura porta	Estensibilità mm
mm	mm	Glass weight kgs	Door opening	Extension mm
700	2000	25	530	680 - 695
800	2000	27	620	770 - 785
900	2000	30	720	870 - 885
1000	2000	35	820	970 - 985

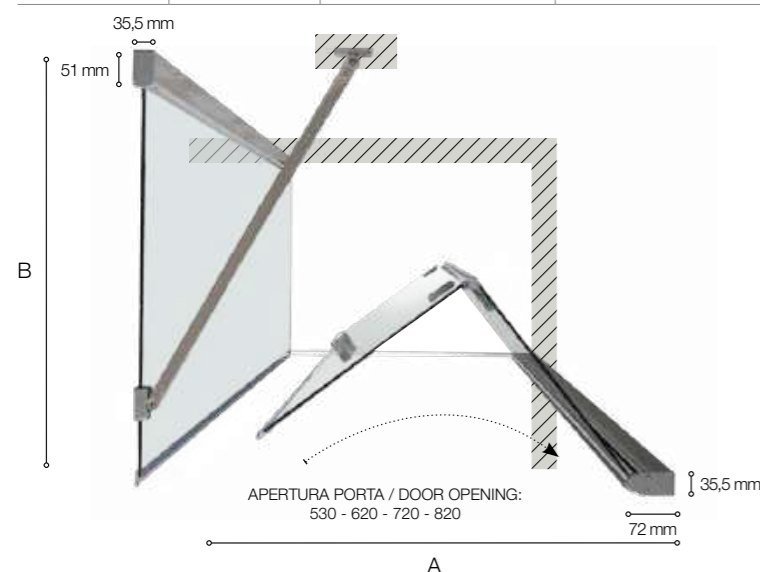

Versione angolare DX  
Right corner version

**PORTA ABBINATA A LATO FISSO**  
DOOR MATCHED WITH FIXED PANEL

Specifiche tecniche / Technical specifications		
P/D	H/H	Estensibilità mm
mm	mm	Extension mm
700	2000	680 - 695
800	2000	770 - 785
900	2000	870 - 885
1000	2000	970 - 985

**DIMENSIONI LATO FISSO (B)**  
FIXED SIDE PANEL SIZE (B)

Specifiche tecniche / Technical specifications			
P/D	H/H	Peso vetro kg	Estensibilità mm
mm	mm	Glass weight kgs	Extension mm
700	2007	22	680 - 700
800	2007	25	770 - 790
900	2007	28	870 - 890
1000	2007	31	970 - 990

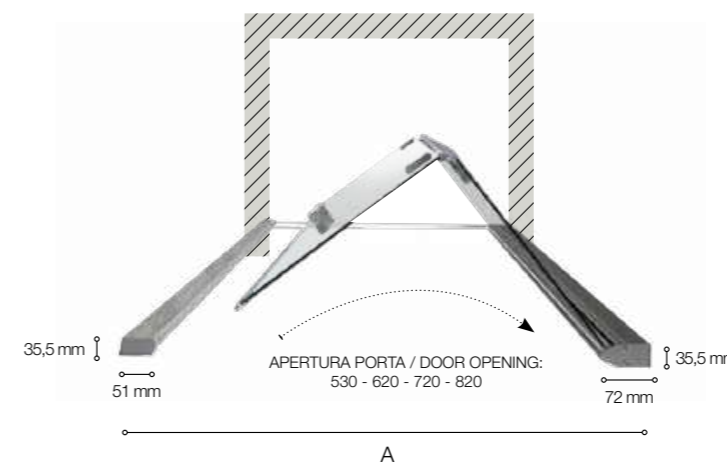

Versione Nicchia  
Niche Version

**DIMENSIONI PORTA (A) (NICCHIA) CON PROFILO DI CHIUSURA NTPC01**  
DOOR SIZE (A) (NICHE) WITH CLOSING PROFILE NTPC01

Specifiche tecniche / Technical specifications				
L/W	H/H	Peso vetro kg	Apertura porta	Estensibilità mm
mm	mm	Glass weight kgs	Door opening	Extension mm
700	2000	27	530	720 - 755
800	2000	29	620	810 - 845
900	2000	32	720	910 - 945
1000	2000	35	820	1010 - 1045

**DIMENSIONI PORTA (A) (NICCHIA) CON PROFILO DI CHIUSURA NTPC03**  
DOOR SIZE (A) (NICHE) WITH CLOSING PROFILE NTPC03

Specifiche tecniche / Technical specifications				
L/W	H/H	Peso vetro kg	Apertura porta	Estensibilità mm
mm	mm	Glass weight kgs	Door opening	Extension mm
700	2000	27	530	685 - 705
800	2000	29	620	775 - 795
900	2000	32	720	875 - 895
1000	2000	35	820	975 - 995

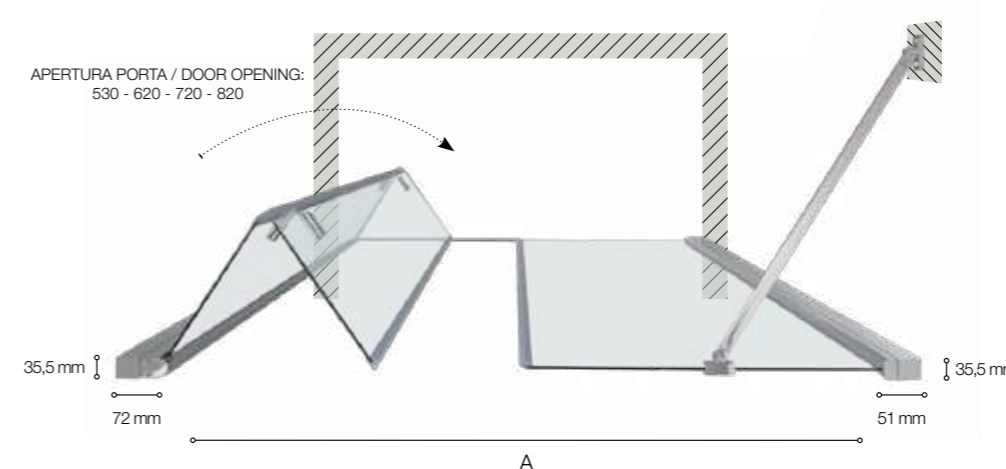

Versione Nicchia  
Niche Version

**DIMENSIONI NICCHIA PORTA + FISSO IN LINEA**  
NICHE DOOR DIMENSIONS + FIXED PANEL

TELF - TPS35 MM	700	800	900	1000
700	1327 - 1367	1417 - 1457	1517 - 1557	1617 - 1657
800	1417 - 1457	1507 - 1547	1607 - 1647	1707 - 1747
900	1517 - 1557	1607 - 1647	1707 - 1747	1807 - 1847
1000	1617 - 1657	1707 - 1747	1807 - 1847	1907 - 1947

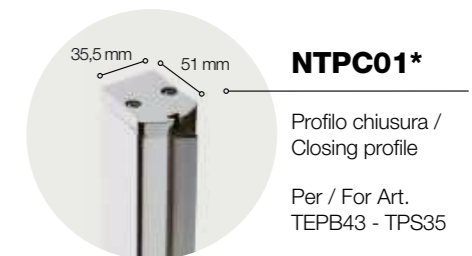

**NTPC01\***

Profilo chiusura /  
Closing profile

Per / For Art.  
TEPB43 - TPS35

\* riferimento immagine  
photo reference

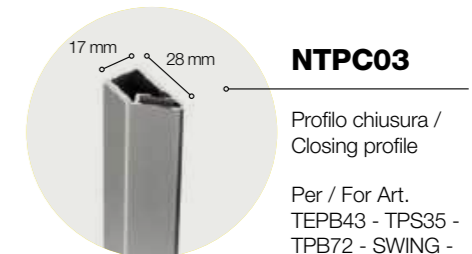

**NTPC03**

Profilo chiusura /  
Closing profile

Per / For Art.  
TEPB43 - TPS35 -  
TPB72 - SWING -  
INFINITY

# Parete cromo

## walk-in

Una soluzione pensata per gli spazi aperti. Essenziale e funzionale, è un box doccia dal gusto contemporaneo. Le aste di fissaggio superiori ne aumentano la robustezza.

A solution designed for open spaces. Minimalistic and functional, it is a contemporary-style shower enclosure. The upper support arms enhance its sturdiness.

### versioni\_versions

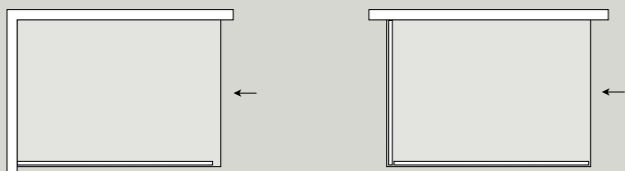

Soluzione aperta  
Versione: Walk-in

Soluzione aperta  
Versione: Walk-in

Open solution  
Version: Walk-in

Open solution  
Version: Walk-in

### caratteristiche tecniche\_technical characteristics



easy clean

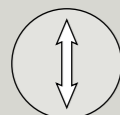

**h 2007 mm**  
altezza  
height



reversibile  
reversible

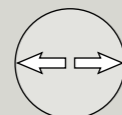

**25 mm**  
regolazione  
adjustment



**6 mm**  
cristallo temperato  
tempered glass



**TPA10**  
**+30 mm**  
profilo di allungamento  
adjustable profile

### finiture\_finishes



cromo  
chrome

### cristallo\_glass



Cristallo trasparente  
Transparent glass

box doccia 6 mm / 6 mm shower box



box doccia 6 mm

Parete cromo  
walk-in walk-in



**Sirena**  
colonna doccia  
shower column

**Ceramic.30**  
piatto doccia Bianco matt  
White matt shower tray



Parete cromo  
walk-in\_walk-in

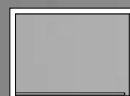

**Pretoria**  
colonna doccia  
shower column

**Ceramic.30**  
piatto doccia Bianco matt  
White matt shower tray



Parete cromo  
walk-in\_walk-in



**Pretoria**  
colonna doccia  
shower column

**Ceramic.30**  
piatto doccia Bianco matt  
White matt shower tray



Parete cromo  
walk-in\_walk-in

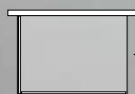

Pretoria  
colonna doccia  
shower column

Ceramic.30  
piatto doccia Bianco matt  
White matt shower tray



box doccia 6 mm

# Parete cromata walk-in

Soluzione aperta\_Open solution **H 2007 mm**

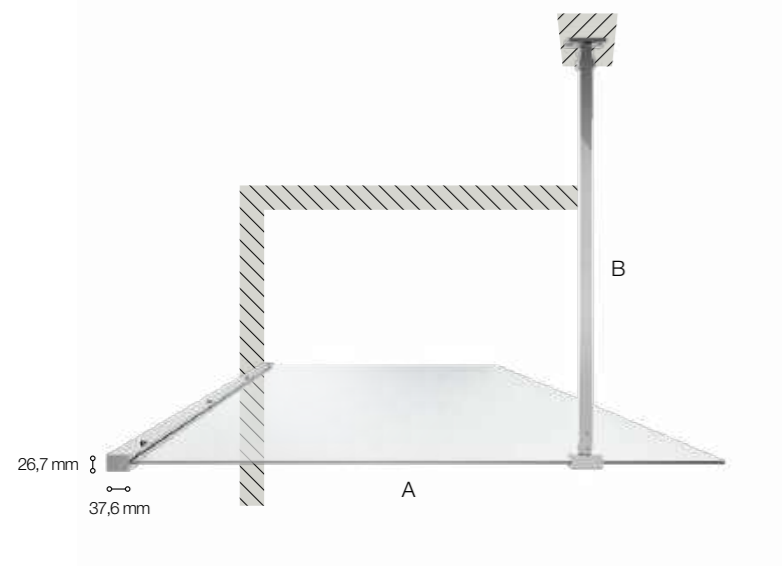

**WALK-IN**  
WALK-IN

**(B) Asta di fissaggio tagliabile, snodabile 1200 mm**  
(B) Cuttable, adjustable support arm 1200 mm

Specifiche tecniche / Technical specifications				
Dimensioni (A) / Sizes (A)				
L/W	H/H	Peso vetro kg	Estensibilità mm	Asta di fissaggio tagliabile mm (B)
mm	mm	Glass weight kgs	Extension mm	Cuttable support arm mm (B)
650	2007	22	607 - 632	1200
700	2007	23	657 - 682	1200
750	2007	27	707 - 732	1200
800	2007	28	757 - 782	1200
850	2007	29	807 - 832	1200
900	2007	31	857 - 882	1200
950	2007	33	907 - 932	1200
1000	2007	35	957 - 982	1200
1100	2007	37	1057 - 1082	1200
1200	2007	40	1157 - 1182	1200
1300	2007	44	1257 - 1282	1200
1400	2007	47	1357 - 1382	1200

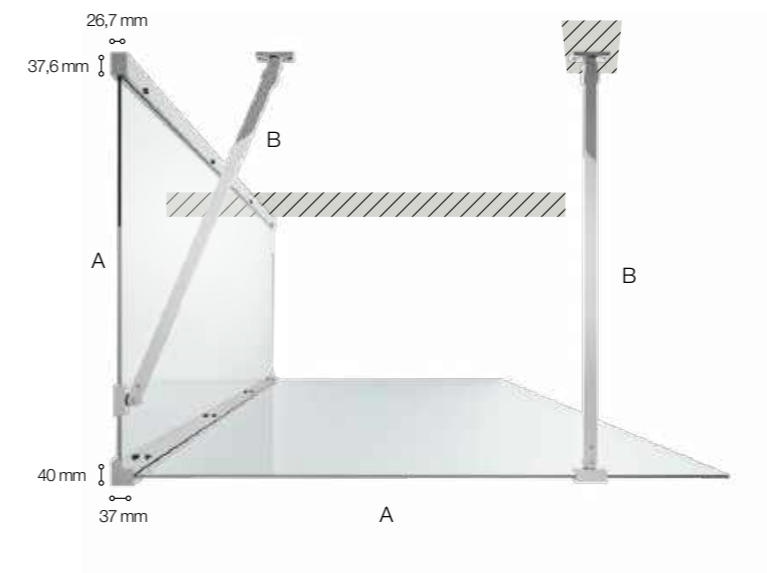

**WALK-IN**  
WALK-IN

**(B) Asta di fissaggio tagliabile, snodabile 1200 mm**  
(B) Cuttable, adjustable support arm 1200 mm

Specifiche tecniche / Technical specifications				
Dimensioni (A) / Sizes (A)				
L/W	H/H	Peso vetro kg	Estensibilità mm	Asta di fissaggio tagliabile mm (B)
mm	mm	Glass weight kgs	Extension mm	Cuttable support arm mm (B)
650	2007	22	635 - 660	1200
700	2007	23	685 - 710	1200
750	2007	27	735 - 760	1200
800	2007	28	785 - 810	1200
850	2007	29	835 - 860	1200
900	2007	31	885 - 910	1200
950	2007	33	935 - 960	1200
1000	2007	35	985 - 1010	1200
1100	2007	37	1085 - 1110	1200
1200	2007	40	1185 - 1210	1200
1300	2007	44	1285 - 1310	1200
1400	2007	47	1385 - 1410	1200

# Parete nera

## walk-in

La finitura nero accentua il senso di solidità della struttura, ripetendosi su profili e aste di fissaggio superiori. Ideale per l'installazione in spazi aperti.

The black finish enhances the sense of strength in the structure, repeating on the profiles and upper support arms. Ideal for installation in open spaces.

### versioni\_versions

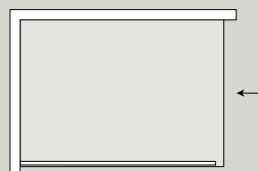

Soluzione aperta  
Versione: Walk-in

Open solution  
Version: Walk-in

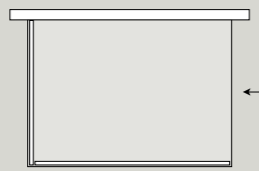

Soluzione aperta  
Versione: Walk-in

Open solution  
Version: Walk-in

### caratteristiche tecniche\_technical characteristics



easy clean

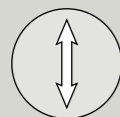

**h 2007 mm**  
altezza  
height

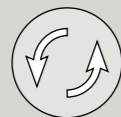

reversibile  
reversible

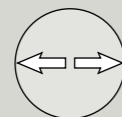

**25 mm**  
regolazione  
adjustment



**6 mm**  
cristallo temperato  
tempered glass



**TPA10NE**  
**+30 mm**  
profilo di allungamento  
adjustable profile

### finiture\_finishes



nero matt  
black matt

### cristallo\_glass



Cristallo trasparente  
Transparent glass

box doccia 6 mm / 6 mm shower box



box doccia 6 mm

Parete nera  
walk-in walk-in

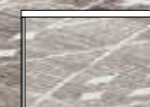

**Tritone**  
colonna doccia  
shower column

**Ceramic.30**  
piatto doccia Bianco matt  
White matt shower tray





Parete nera  
walk-in\_walk-in

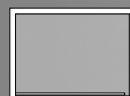

**Tritone**  
colonna doccia  
shower column

**Ceramic.30**  
piatto doccia Bianco matt  
White matt shower tray



Parete nera  
walk-in\_walk-in



**Tritone**  
colonna doccia  
shower column

**Ceramic.30**  
piatto doccia Bianco matt  
White matt shower tray



Parete nera  
walk-in\_walk-in

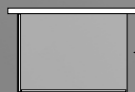

**Tritone**  
colonna doccia  
shower column

**Ceramic.30**  
piatto doccia Bianco matt  
White matt shower tray



box doccia 6 mm

# Parete nera walk-in

Soluzione aperta\_Open solution **H 2007 mm**

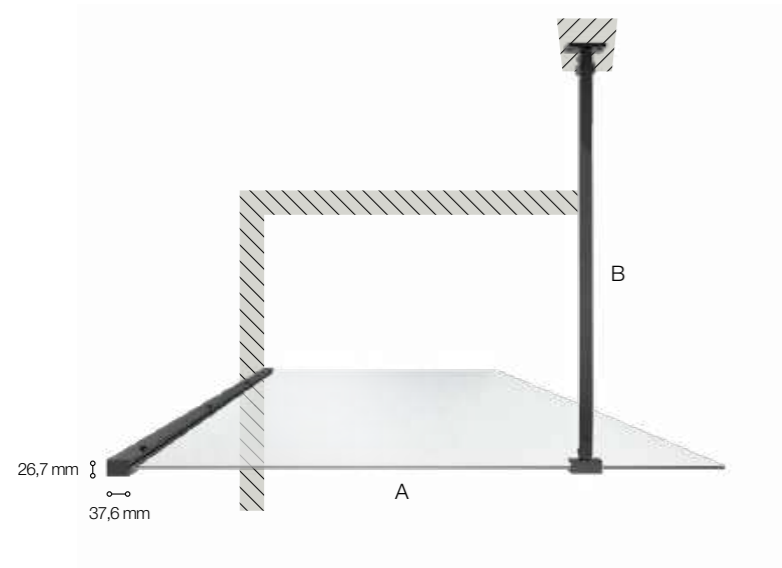

**WALK-IN**  
WALK-IN

**(B) Asta di fissaggio tagliabile,snodabile 1200 mm**  
(B) Cuttable,adjustable support arm 1200 mm

## Specifiche tecniche / Technical specifications

### Dimensioni (A) / Sizes (A)

L/W mm	H/H mm	Peso vetro kg	Estensibilità mm	Asta di fissaggio tagliabile mm (B)
		Glass weight kgs	Extension mm	Cuttable support arm mm (B)
650	2007	22	607 - 632	1200
700	2007	23	657 - 682	1200
750	2007	27	707 - 732	1200
800	2007	28	757 - 782	1200
850	2007	29	807 - 832	1200
900	2007	31	857 - 882	1200
950	2007	33	907 - 932	1200
1000	2007	35	957 - 982	1200
1100	2007	37	1057 - 1082	1200
1200	2007	40	1157 - 1182	1200
1300	2007	44	1257 - 1282	1200
1400	2007	47	1357 - 1382	1200

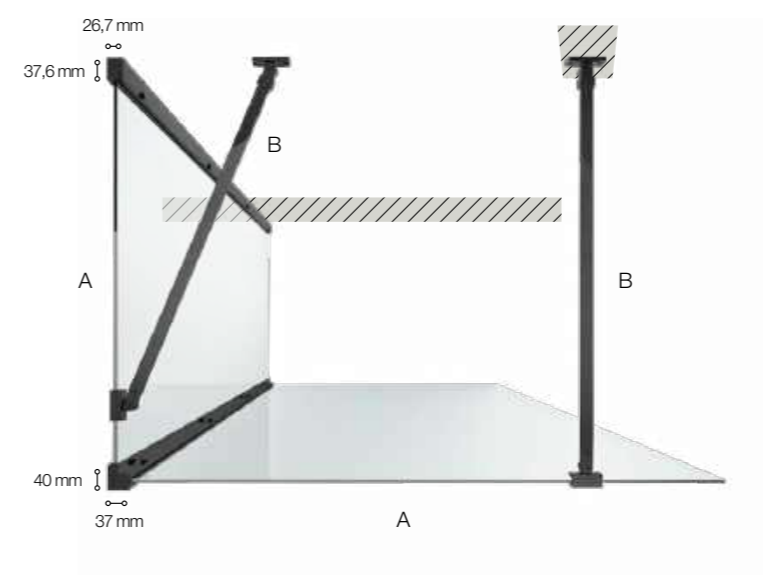

**WALK-IN**  
WALK-IN

**(B) Asta di fissaggio tagliabile,snodabile 1200 mm**  
(B) Cuttable,adjustable support arm 1200 mm

## Specifiche tecniche / Technical specifications

### Dimensioni (A) / Sizes (A)

L/W mm	H/H mm	Peso vetro kg	Estensibilità mm	Asta di fissaggio tagliabile mm (B)
		Glass weight kgs	Extension mm	Cuttable support arm mm (B)
650	2007	22	635 - 660	1200
700	2007	23	685 - 710	1200
750	2007	27	735 - 760	1200
800	2007	28	785 - 810	1200
850	2007	29	835 - 860	1200
900	2007	31	885 - 910	1200
950	2007	33	935 - 960	1200
1000	2007	35	985 - 1010	1200
1100	2007	37	1085 - 1110	1200
1200	2007	40	1185 - 1210	1200
1300	2007	44	1285 - 1310	1200
1400	2007	47	1385 - 1410	1200

# Parete alluminio spazzolato

## walk-in

La finitura in alluminio spazzolato aggiunge un tocco di raffinatezza a un box doccia che fa dell'essenzialità estetica il proprio punto di forza. Ideale per l'installazione in spazi aperti.

The brushed nickel finish brings a touch of refinement to a shower enclosure that prides itself on its aesthetic simplicity. It is an ideal choice for installation in open spaces.

### versioni\_versions

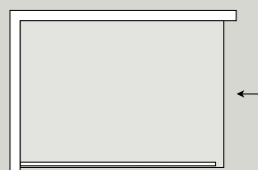

Soluzione aperta  
Versione: Walk-in

Open solution  
Version: Walk-in

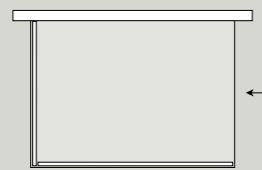

Soluzione aperta  
Versione: Walk-in

Open solution  
Version: Walk-in

### caratteristiche tecniche\_technical characteristics



easy clean

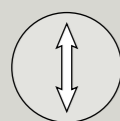

**h 2007 mm**  
altezza  
height

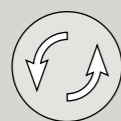

reversibile  
reversible

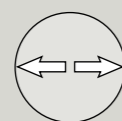

**25 mm**  
regolazione  
adjustment



**6 mm**  
cristallo temperato  
tempered glass



**TPA10AS**  
**+30 mm**  
profilo di allungamento  
adjustable profile

### finiture\_finishes



alluminio spazzolato  
brushed nickel

### cristallo\_glass



Cristallo trasparente  
Transparent glass



Parete alluminio spazzolato  
walk-in\_walk-in

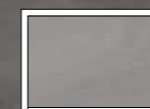

**Sirena**  
colonna doccia  
shower column

**Ceramic.30**  
piatto doccia Bianco matt  
White matt shower tray



Parete alluminio spazzolato  
walk-in\_walk-in

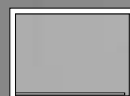

**Pretoria**  
colonna doccia  
shower column

**Ceramic.30**  
piatto doccia Bianco matt  
White matt shower tray



Parete alluminio spazzolato  
walk-in\_walk-in



**Pretoria**  
colonna doccia  
shower column

**Ceramic.30**  
piatto doccia Bianco matt  
White matt shower tray



Parete alluminio spazzolato  
walk-in\_walk-in

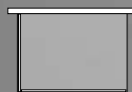

**Pretoria**  
colonna doccia  
shower column

**Ceramic.30**  
piatto doccia Bianco matt  
White matt shower tray



box doccia 6 mm

# Parete alluminio spazzolato walk-in

Soluzione aperta\_Open solution **H 2007 mm**

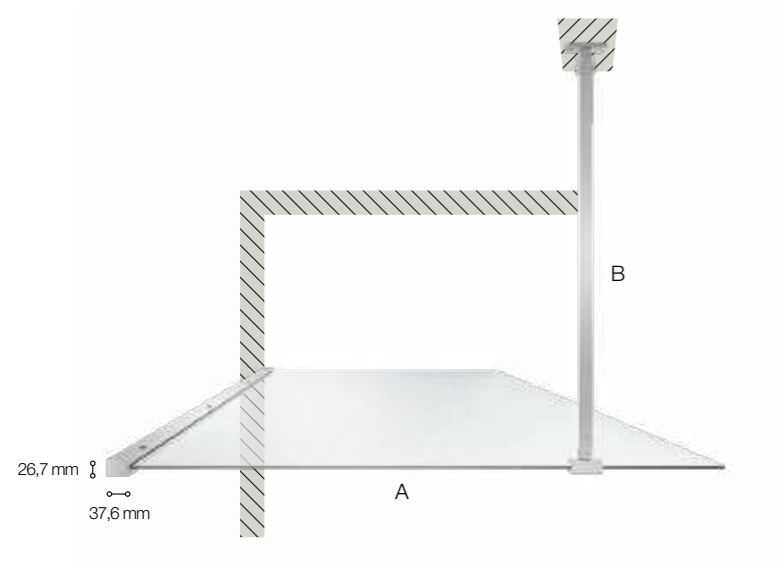

**WALK-IN**  
WALK-IN

**(B) Asta di fissaggio tagliabile, snodabile 1200 mm**  
(B) Cuttable, adjustable support arm 1200 mm

## Specifiche tecniche / Technical specifications

### Dimensioni (A) / Sizes (A)

L/W mm	H/H mm	Peso vetro kg	Estensibilità mm	Asta di fissaggio tagliabile mm (B)
		Glass weight kgs	Extension mm	Cuttable support arm mm (B)
650	2007	22	607 - 632	1200
700	2007	23	657 - 682	1200
750	2007	27	707 - 732	1200
800	2007	28	757 - 782	1200
850	2007	29	807 - 832	1200
900	2007	31	857 - 882	1200
950	2007	33	907 - 932	1200
1000	2007	35	957 - 982	1200
1100	2007	37	1057 - 1082	1200
1200	2007	40	1157 - 1182	1200
1300	2007	44	1257 - 1282	1200
1400	2007	47	1357 - 1382	1200

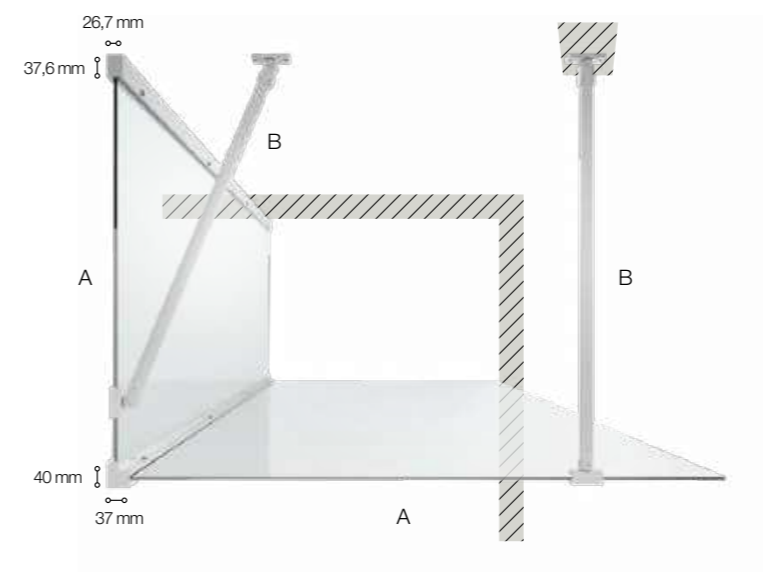

**WALK-IN**  
WALK-IN

**(B) Asta di fissaggio tagliabile, snodabile 1200 mm**  
(B) Cuttable, adjustable support arm 1200 mm

## Specifiche tecniche / Technical specifications

### Dimensioni (A) / Sizes (A)

L/W mm	H/H mm	Peso vetro kg	Estensibilità mm	Asta di fissaggio tagliabile mm (B)
		Glass weight kgs	Extension mm	Cuttable support arm mm (B)
650	2007	22	635 - 660	1200
700	2007	23	685 - 710	1200
750	2007	27	735 - 760	1200
800	2007	28	785 - 810	1200
850	2007	29	835 - 860	1200
900	2007	31	885 - 910	1200
950	2007	33	935 - 960	1200
1000	2007	35	985 - 1010	1200
1100	2007	37	1085 - 1110	1200
1200	2007	40	1185 - 1210	1200
1300	2007	44	1285 - 1310	1200
1400	2007	47	1385 - 1410	1200

# TSV50

TSV50 è un sovravasca per creare una vasca-doccia elegante e funzionale. Il cristallo ad anta fissa è ancorato a un'asta di fissaggio superiore, coordinata nel colore al profilo.

TSV50 is an over-bath solution to create an elegant and functional bathtub-shower combination. The fixed door glass is anchored to an upper support arm, coordinated in color with the profile.

## versioni\_versions

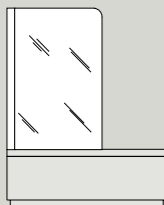

Sopravasca  
Versione: 1 anta fissa  
Bathtub shower panel  
Version: fixed door

## caratteristiche tecniche\_technical characteristics



easy clean

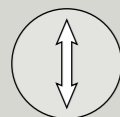

**h 1500 mm**  
altezza  
height

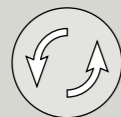

reversibile  
reversible

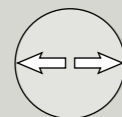

**15 mm**  
regolazione  
adjustment



**5 mm**  
cristallo temperato  
tempered glass

## finiture\_finishes



cromo  
chrome

## cristallo\_glass



Cristallo trasparente  
Transparent glass



TSV50  
sopravasca\_bathtub shower panel



Sharm  
vasca rettangolare  
rectangular bathtub



# TSV50

Soprasvasca\_Bathtub shower panel **H 1500 mm**

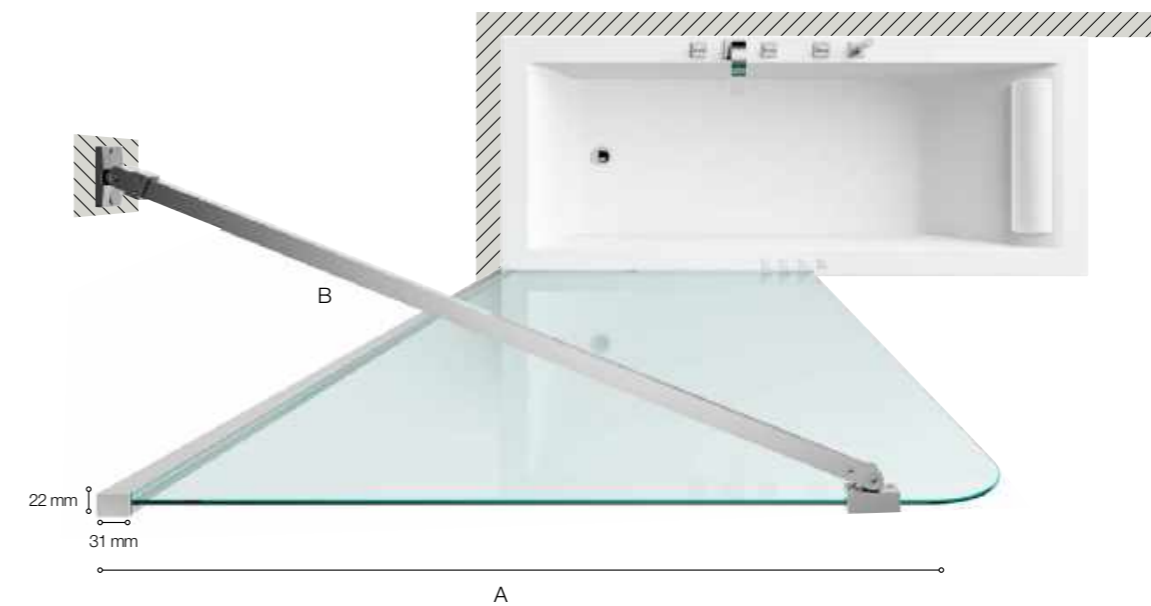

**BOX COMPLETO**  
COMPLETE SHOWER ENCLOSURE

#### Specifiche tecniche / Technical specifications

#### Dimensioni (A) / Sizes (A)

L/W (A) mm	H/H mm	Peso vetro kg	Asta di fissaggio tagliabile mm (B)
		Glass weight kgs	Cutttable support arm mm (B)
900	1500	21	880

# TSV51

Risolve in maniera elegante e discreta la richiesta di una vasca-doccia per ambienti più piccoli.

An elegant and manner to create a bathtub-shower for small environments.

## versioni\_versions

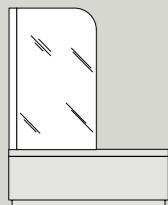

Soprasvasca  
Versione: 1 anta mobile  
Bathtub shower panel  
Version: movable door

## caratteristiche tecniche\_technical characteristics



easy clean

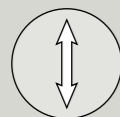

**h 1500 mm**  
altezza  
height

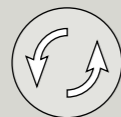

reversibile  
reversible

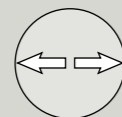

**15 mm**  
regolazione  
adjustment



**5 mm**  
cristallo temperato  
tempered glass

## finiture\_finishes



cromo  
chrome

## cristallo\_glass



Cristallo trasparente  
Transparent glass

box doccia 6 mm / 6 mm shower box



TSV51  
soprasvasca\_bathtub shower panel



Sharm  
vasca rettangolare  
rectangular bathtub

# TSV51

Soprasvasca\_Bathtub shower panel H 1500 mm

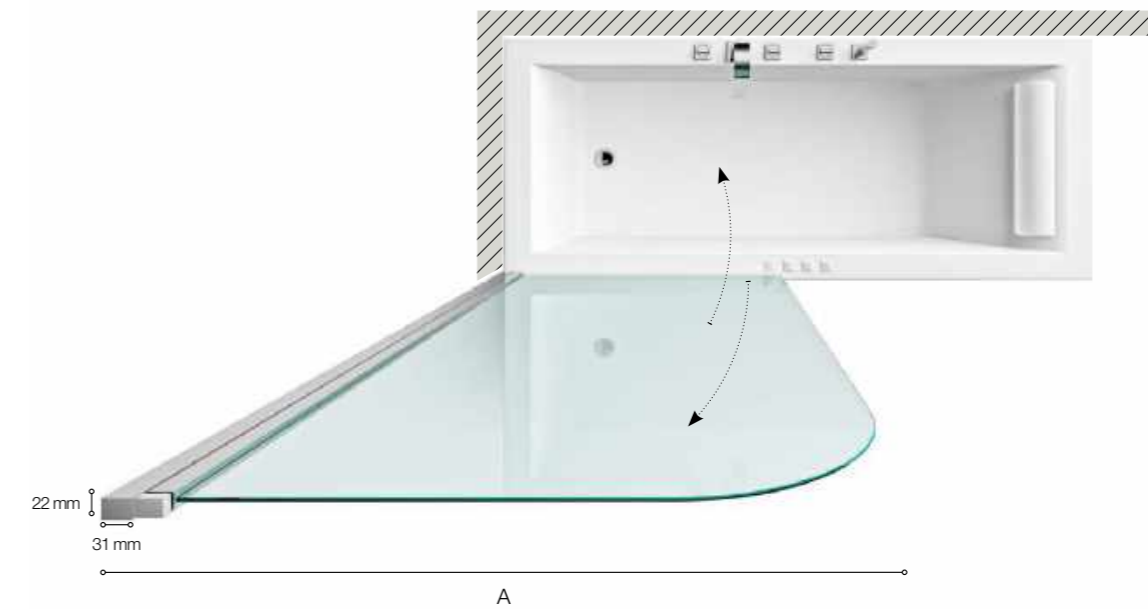

## BOX COMPLETO COMPLETE SHOWER ENCLOSURE

Specifiche tecniche / Technical specifications		
L/W (A)	H/H	Peso vetro kg Glass weight kgs
mm	mm	
750	1500	16

# TSV52

Si adattano a tutte le vasche con un bordo piatto e si possono montare o a lastra singola o con due vetri richiudibili a formare, in base all'occasione anche un box angolare.

They adapt to all bathtubs with a flat edge and can be installed as a single door or a bi-fold door that, on occasion, can also form a corner enclosure.

## versioni\_versions

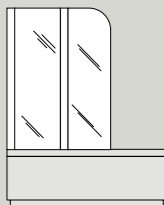

Sopra vasca  
Versione: 2 ante pieghevoli e reversibile

Bathtub shower panel  
Version: reversible two folding doors

## caratteristiche tecniche\_technical characteristics



easy clean

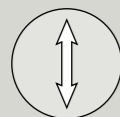

**h 1500 mm**  
altezza  
height

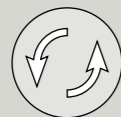

reversibile  
reversible

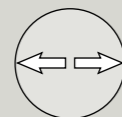

**15 mm**  
regolazione  
adjustment

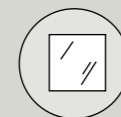

**5 mm**  
cristallo temperato  
tempered glass

## finiture\_finishes



cromo  
chrome

## cristallo\_glass



Cristallo trasparente  
Transparent glass



TSV52  
sopra vasca\_bathtub shower panel

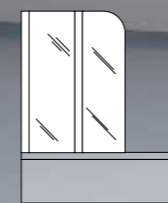

Sharm  
vasca rettangolare  
rectangular bathtub

# TSV52

Soprasvasca\_Bathtub shower panel H 1500 mm



I soprasvasca creano protezione e sicurezza nell'utilizzo doccia della vasca.

The above bathtub elements create protection and safety in using the bathtub shower.

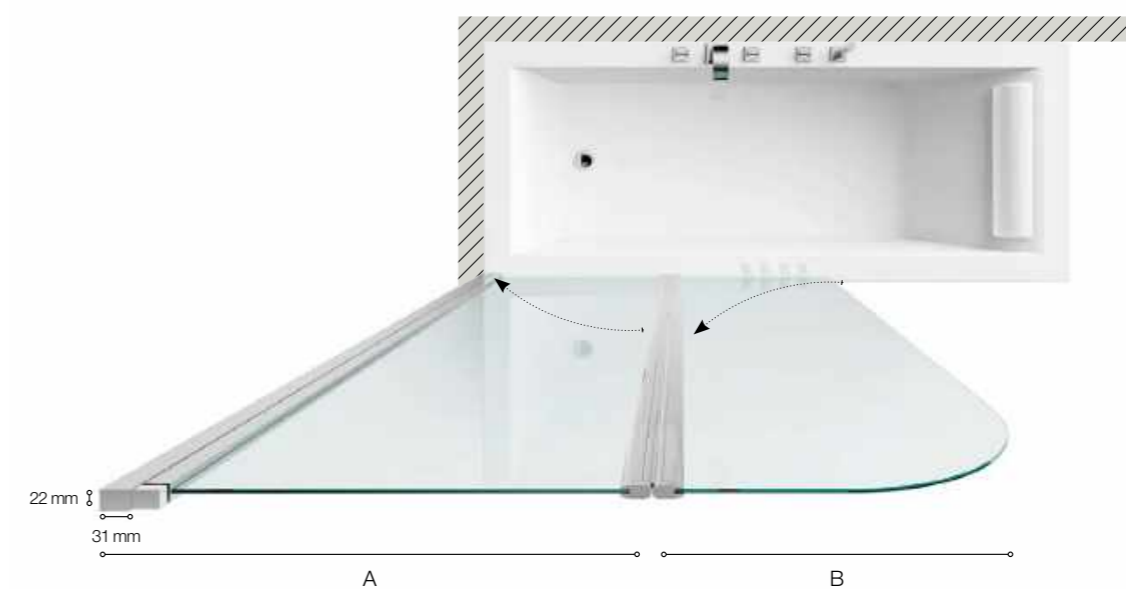

Doppio elemento pieghevole a 180°  
180° double folding bathtub screen

**BOX COMPLETO**  
COMPLETE SHOWER ENCLOSURE

Specifiche tecniche / Technical specifications			
L/W (A)	L/W (B)	H/H	Peso vetro kg
mm	mm	mm	Glass weight kgs
598	542	1500	24

# TSV53

Pensato per chi desidera uno spazio doccia più ampio, da ricreare all'occorrenza all'interno della propria vasca. Un sopravasca pieghevole, dotato di due ante scorrevoli e pieghevoli.

Designed for those seeking a more expansive shower space, which can be easily created within their bathtub. A foldable bathtub shower panel with two sliding and folding doors.

## versioni\_versions

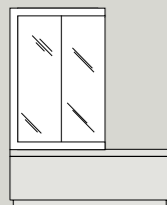

Sopravasca  
Versione: 2 ante scorrevoli/pieghevoli

Bathtub shower panel  
Version: 2 sliding/folding doors

## caratteristiche tecniche\_technical characteristics



easy clean

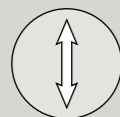

**h 1500 mm**  
altezza  
height

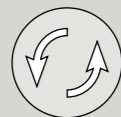

reversibile  
reversible

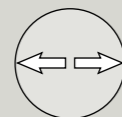

**15 mm**  
regolazione  
adjustment

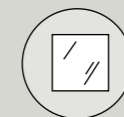

**5 mm**  
cristallo temperato  
tempered glass

## finiture\_finishes



cromo  
chrome

## cristallo\_glass



Cristallo trasparente  
Transparent glass

TSV53  
sopravasca\_bathtub shower panel



Sharm  
vasca rettangolare  
rectangular bathtub

# TSV53

Soprasvasca\_Bathtub shower panel H 1500 mm

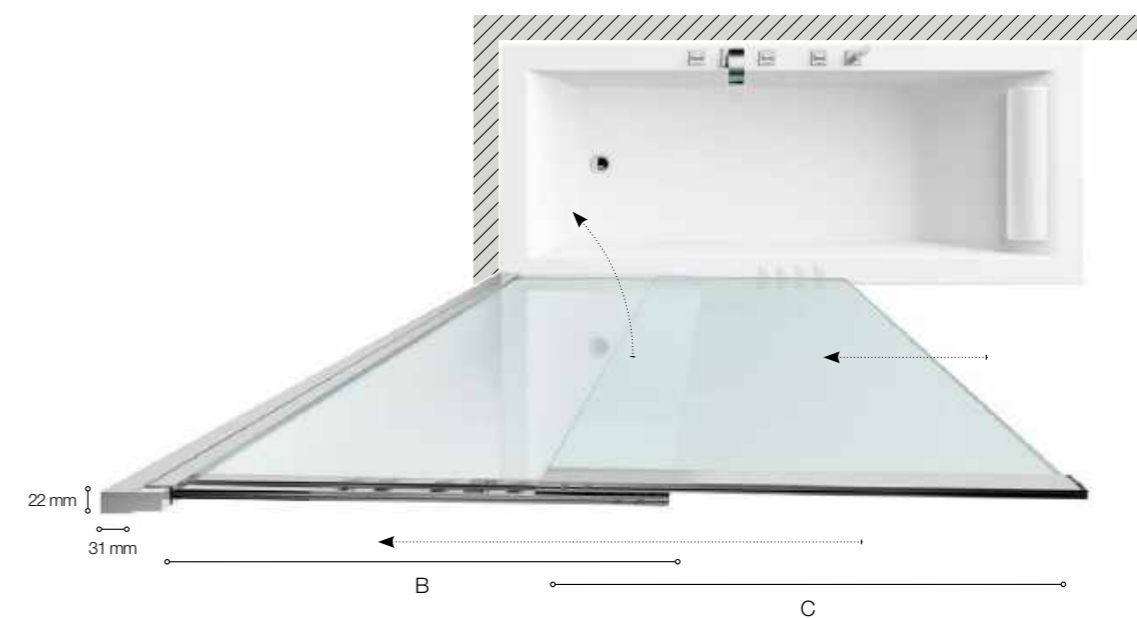

**BOX COMPLETO**  
COMPLETE SHOWER ENCLOSURE

Specifiche tecniche / Technical specifications				
B	C	H/H	Estensibilità mm	Peso vetro kg
mm	mm	mm	Extension mm	Glass weight kgs
624	571	1500	678 - 1136	26

# piatti doccia

## shower trays

### ceramica

ceramic

**CERAMIC.30**  
quadrato / square  
rettangolare / rectangular

270

### marmoresina

marble-resin

**PLAN**  
quadrato / square  
rettangolare / rectangular

276

**FLAT**  
quadrato / square  
rettangolare / rectangular  
angolare / corner

280

**FLAT/BORDO**  
quadrato / square  
rettangolare / rectangular

286

### poliestere

polyester

**SMC**  
quadrato / square  
rettangolare / rectangular

292

**ACRYLIC H3**  
quadrato / square  
rettangolare / rectangular  
angolare / corner

296

**ACRYLIC H5/BORDO**  
quadrato / square  
rettangolare / rectangular

302

### pannelli rivestimento

wall covering panels

306



# Ceramic.30

Piatto doccia dallo spessore di soli 3 cm, installabile sia in appoggio che filo pavimento. La pregiata ceramica di cui è composto assicura un'ottima resistenza ai graffi e al calcare e rende possibile il taglio su misura.

A shower tray with a thickness of only 3 cm, suitable for installation both on top or flush with the floor. Its high-quality ceramic ensures excellent resistance to scratches and limescale, allowing for custom cutting.

## versioni\_versions

Quadrato  
Square

80x80xh 3 cm \_ 28 kg

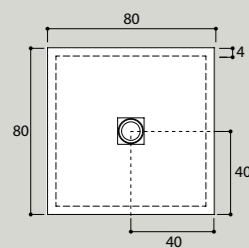

Rettangolare  
Rectangular

70x90xh 3 cm \_ 28 kg  
70x100xh 3 cm \_ 32 kg  
70x120xh 3 cm \_ 38 kg  
70x140xh 3 cm \_ 41 kg  
80x90xh 3 cm \_ 30 kg  
80x100xh 3 cm \_ 35 kg  
80x120xh 3 cm \_ 43 kg  
80x140xh 3 cm \_ 48 kg  
90x120xh 3 cm \_ 48 kg

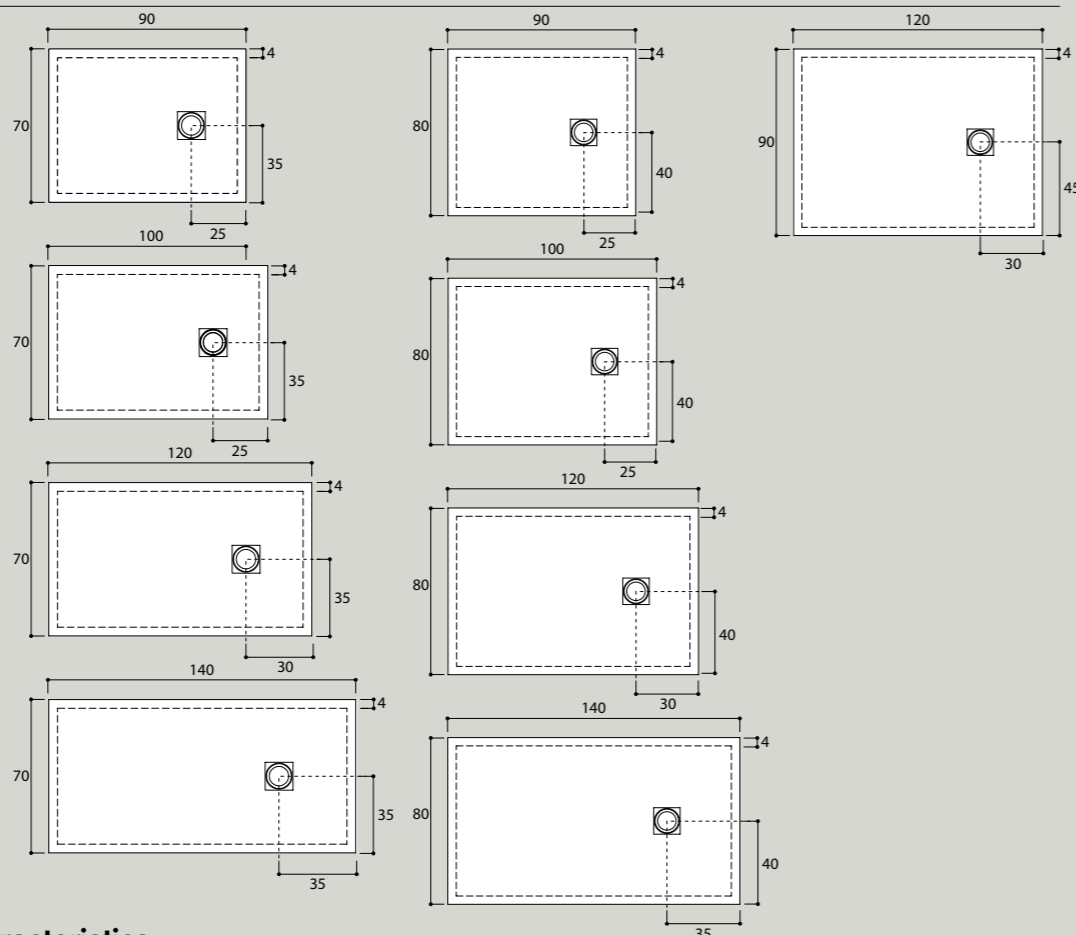

## caratteristiche tecniche\_technical characteristics



superficie antibatterica  
antibacterial surface



pulizia facile  
easy clean

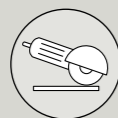

facile al taglio  
easy to cut

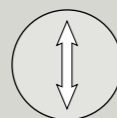

**3 cm**  
minimo spessore  
minimum thickness



texture antiscivolo  
non-slip texture



antimacchia  
stain resistant



resistente agli acidi  
resistant to acids

## colori\_colors



bianco matt  
white matt



avorio matt  
ivory matt



cemento matt  
concrete matt



nero matt  
black matt

## griglia\_grates



bianco matt  
matt white  
125x125 mm



avorio matt  
ivory matt  
125x125 mm



cemento matt  
concrete matt  
125x125 mm



nero matt  
matt black  
125x125 mm



acciaio inox  
stainless steel  
125x125 mm

## piletta\_waste



PLPDCE  
Piletta Geberit  
ultrasottile bianca

Geberit ultra-flat  
white drain plug





Ceramic.30  
80x140 cm



Ceramic.30 è reversibile e disponibile in quattro tonalità di colore, che gli permettono di armonizzarsi in tutti gli ambienti bagno.

Ceramic.30 is reversible and available in four colours in order to blend in harmoniously with any bathroom environment.



**Ceramic.30**  
80x140 cm



Una superficie ceramica  
innovativa: antimacchia,  
antiscivolo, antibatterica,  
resistente e al tempo stesso  
facile al taglio per adattarsi a  
ogni spazio.

An innovative ceramic surface:  
stain-resistant, non-slip,  
antibacterial, durable, and at the  
same time easy to cut to fit any  
space.

**Ceramic.30**  
80x120 cm



# Plan

Piatto doccia in marmo resina completo di piletta di scarico e copertura in acciaio inox. La griglia per la piletta di scarico è disponibile anche nel colore bianco.

Marble-resin shower tray complete with trap and stainless steel drain cover. The waste trap grate is also available in white color.

## versioni\_versions

Quadrato  
Square

80x80xh 3 cm \_ 30 kg  
90x90x h 3 cm \_ 38 kg

Rettangolare  
Rectangular

70x90xh 3 cm \_ 30 kg  
70x100xh 3 cm \_ 33 kg  
70x120xh 3 cm \_ 40 kg  
70x140xh 3 cm \_ 47 kg  
70x160xh 3 cm \_ 53 kg  
70x170xh 3 cm \_ 57 kg  
70x180xh 3 cm \_ 60 kg  
80x100xh 3 cm \_ 38 kg  
80x120xh 3 cm \_ 46 kg  
80x140xh 3 cm \_ 53 kg  
80x160xh 3 cm \_ 61 kg  
80x170xh 3 cm \_ 65 kg  
80x180xh 3 cm \_ 68 kg

## caratteristiche tecniche\_technical characteristics

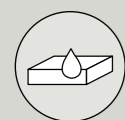

colorato in massa  
pigmented body



pulizia facile  
easy clean



facile al taglio  
easy to cut

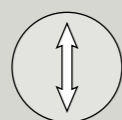

3 cm

minimo spessore  
minimum thickness



texture antiscivolo  
non-slip texture



piacevole al tatto  
pleasant to the touch

## colori\_colors



bianco  
white

## dettagli\_details



Il piatto doccia ha una superficie sottostante liscia.

The trays have a smooth underside.

## piletta\_waste

H 6



Piletta di scarico con copertura in acciaio inox per piatti doccia in marmo resina.

Waste trap cover in stainless steel for marble-resin shower trays.

H 6



La copertura per la piletta di scarico è disponibile anche nel colore bianco.

The waste trap cover is available also in white color.

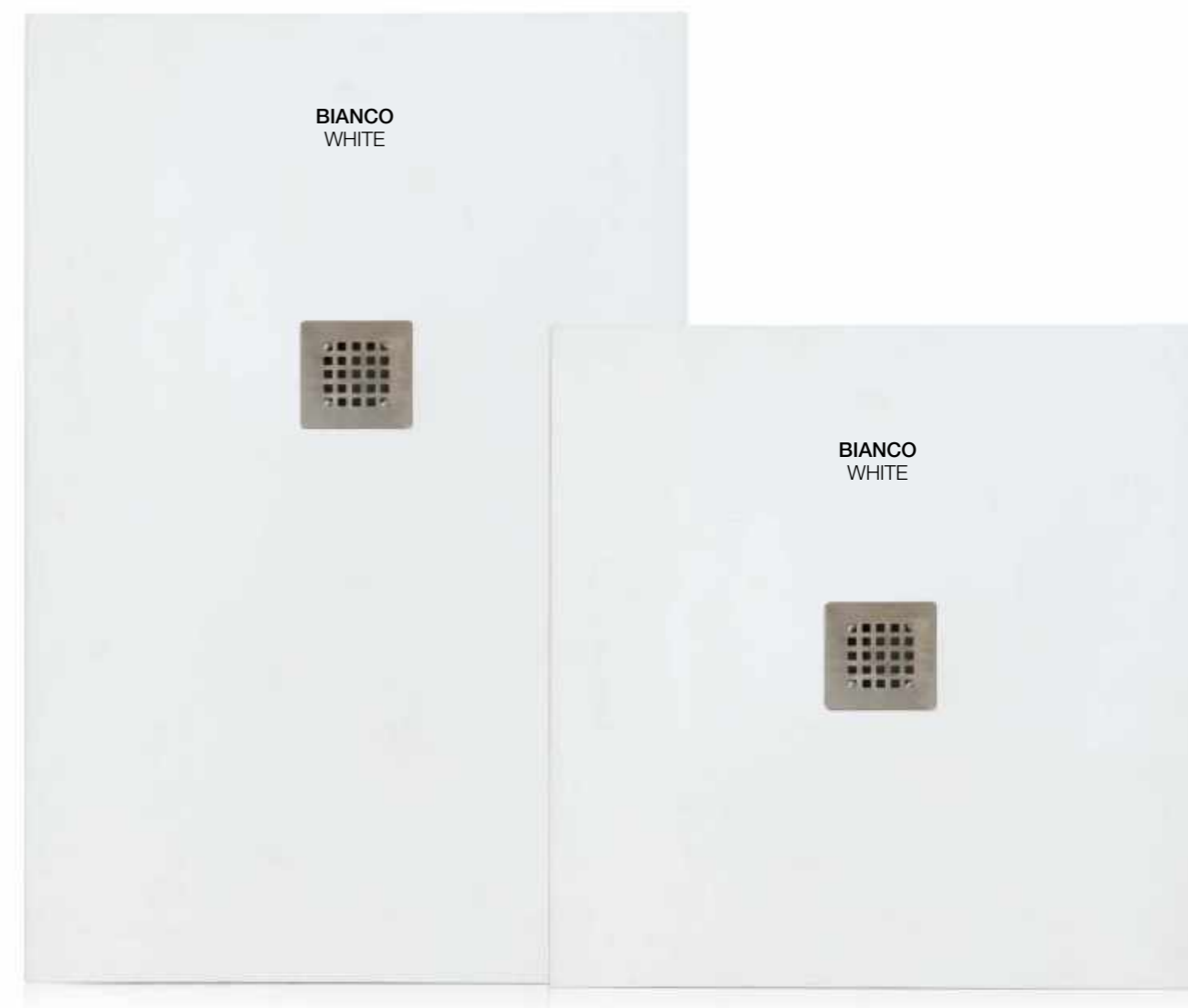



Plan  
120x80 cm



Il piatto doccia Plan, è dotato di piletta di scarico extra piatta.

The Plan shower tray is equipped with an extra flat trap.

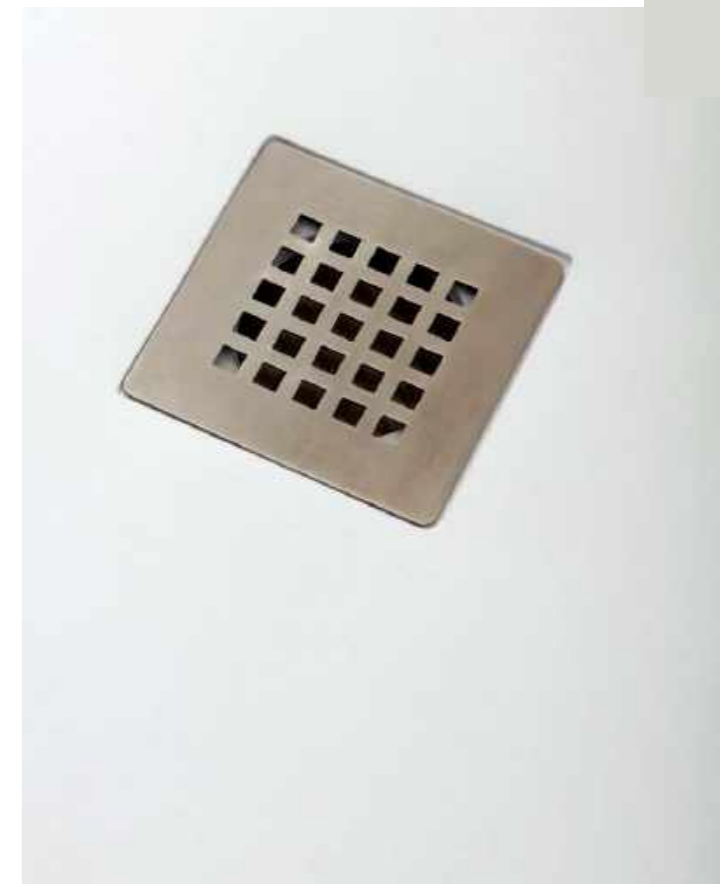

# Flat

Piatto doccia in marmo resina completo di piletta di scarico. Le grate di copertura sono disponibili in cinque diverse finiture: acciaio inox, o in abbinamento con il piatto doccia.

Marble-resin shower tray complete with drain plug included. The cover grates are available in five different finishes: stainless steel, or matching the shower tray.

## versioni\_versions

Quadrato  
Square

80x80xh 2,5 cm \_ 29 kg  
90x90x h 2,5 cm \_ 37 kg

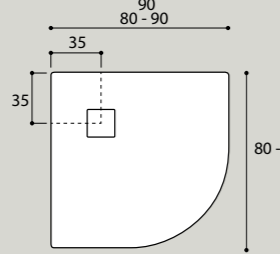
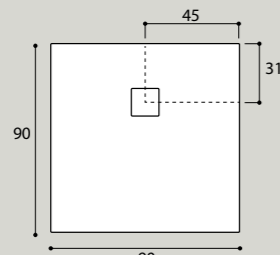
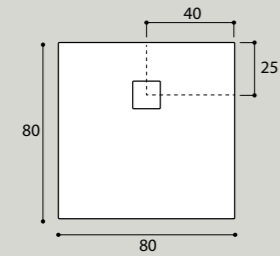

Angolare  
Corner

80x80xh 2,5 cm \_ 26,5 kg  
90x90x h 2,5 cm \_ 34 kg

Rettangolare  
Rectangular

72x90xh 2,5 cm \_ 30 kg  
70x100xh 2,5 cm \_ 31 kg  
70x120xh 2,5 cm \_ 39 kg  
70x140xh 2,5 cm \_ 46 kg  
70x160xh 2,5 cm \_ 50 kg  
70x170xh 2,5 cm \_ 53 kg  
70x180xh 2,5 cm \_ 58 kg  
80x100xh 2,5 cm \_ 36 kg  
80x120xh 2,5 cm \_ 43 kg  
80x140xh 2,5 cm \_ 52 kg  
80x160xh 2,5 cm \_ 56 kg  
80x170xh 2,5 cm \_ 60 kg  
80x180xh 2,5 cm \_ 64 kg  
90x100xh 2,5 cm \_ 38 kg  
90x120xh 2,5 cm \_ 50 kg

90x140xh 3 cm \_ 56 kg  
90x160xh 3 cm \_ 64 kg  
90x170xh 3 cm \_ 68 kg  
90x180xh 3 cm \_ 73 kg

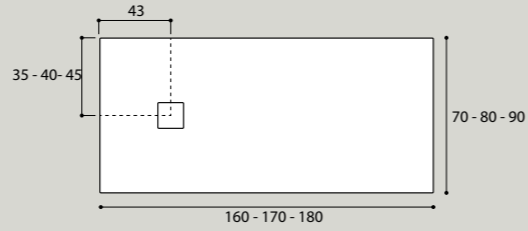
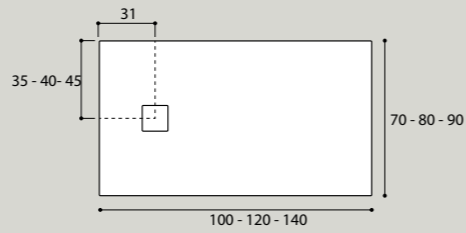
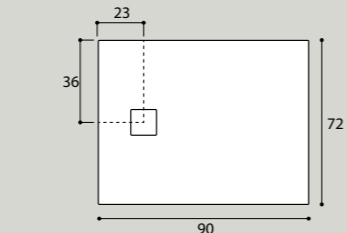

ATTENZIONE:  
le misure indicate possono subire una tolleranza  $\pm 3$  mm. Verificarle in fase di installazione

The sizes listed can have a tolerance of  $\pm 3$  mm. Check the shower tray size before installation

## caratteristiche tecniche\_technical characteristics

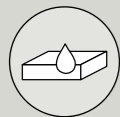

colorato in massa  
pigmented body



pulizia facile  
easy clean

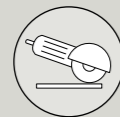

facile al taglio  
easy to cut

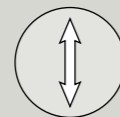

2,5/3 cm

minimo spessore  
minimum thickness



texture antiscivolo  
non-slip texture



superficie antibatterica  
antibacterial surface

## colori\_colors

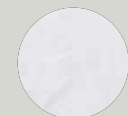

bianco  
white



crema  
cream



grigio cemento  
concrete grey



antracite  
anthracite

## griglie\_grates



bianco  
white  
132x132 mm



crema  
cream  
132x132 mm



grigio cemento  
concrete grey  
132x132 mm



antracite  
anthracite  
132x132 mm



acciaio inox  
stainless steel  
132x132 mm

## piletta\_waste

H 6



Piletta di scarico per i piatti doccia Flat.

Waste trap for Flat shower trays.

## dettagli\_details



Il piatto doccia H 2,5 cm ha una superficie sottostante liscia.

The H 2,5 cm trays have a smooth underside.



Grigliato sottostante del piatto doccia in marmo resina H 3 cm

The H 3 cm trays has a grated underside.

Per misure / for measures:

90x140xh 3 cm    90x170xh 3 cm  
90x160xh 3 cm    90x180xh 3 cm

## possibili tagli\_cutting examples

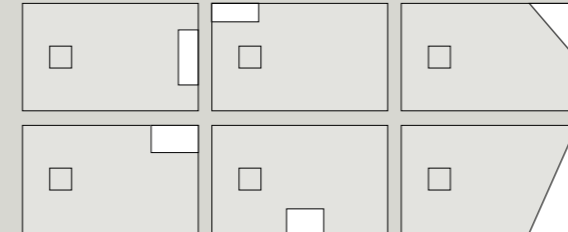



Il piano inclinato facilita lo scorrimento dell'acqua e con soli 2,5 cm di altezza si adatta all'installazione sia filo pavimento che sopra pavimento. Flat è robusto e totalmente pigmentato all'interno. Qualora dovesse scheggiarsi, la parte mancante risulterebbe sempre dello stesso colore rendendo il danno meno evidente. Superficie calpestabile antiscivolo.

The sloped surface helps water drainage. With a height of just 2.5 cm, it can be installed both flush with the floor and above the floor.

Flat is sturdy and fully pigmented inside. If it were to chip, the missing part would always be the same color, making the damage less noticeable. Non-slip walking surface.



Flat  
90x160 cm



Flat  
70x120 cm





Flat  
90x200 cm



Una delle caratteristiche peculiari del marmo resina è la sua alta versatilità. I piatti doccia infatti grazie alla estrema facilità di taglio, risolvono problemi di installazione fuori squadra o di presenza di pilastri o colonne.

One of the peculiar characteristics of marble resin is its high versatility. The shower trays, thanks to the fact that they are easy to cut, resolve out of square installations or problems related to the presence of pillars or columns in the shower tray area.

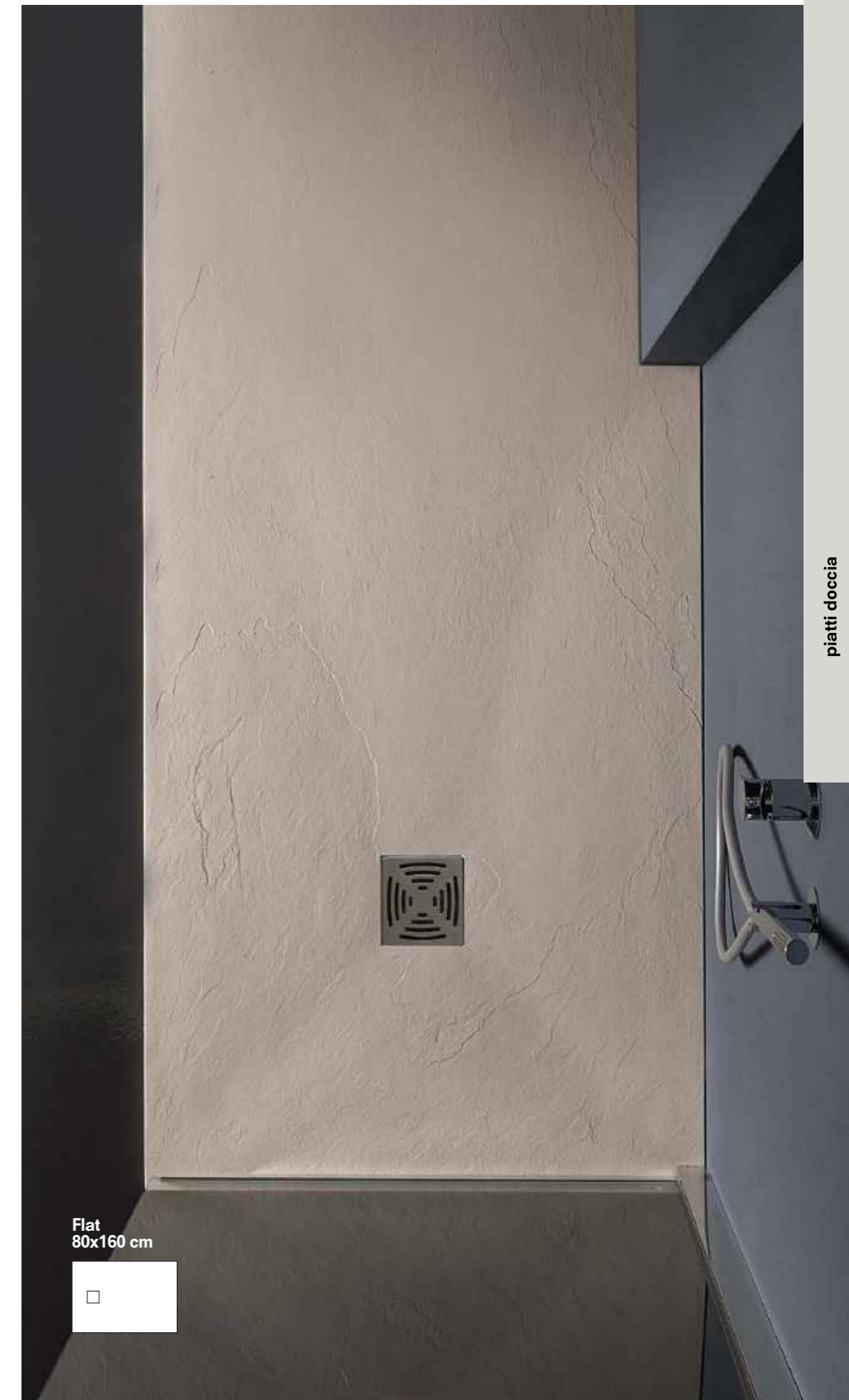

Flat  
80x160 cm





# Flat/Bordo

Piatto doccia con bordo incorporato in tutti i lati in marmo resina, completo di piletta di scarico. Le grate di copertura sono disponibili in cinque diverse finiture: acciaio inox, o in abbinamento con il piatto doccia.

Shower tray with integrated marble resin edges around the entire perimeter, with drain plug included. The cover grates are available in five different finishes: stainless steel, or matching the shower tray.

## versioni\_versions

Quadrato  
Square

80x80xh 3,3 cm \_ 35 kg  
90x90x h 3,3 cm \_ 41 kg

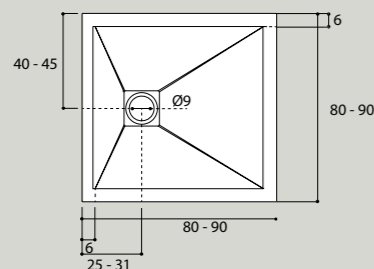

Rettangolare  
Rectangular

72x90xh 3,3 cm \_ 34 kg  
70x100xh 3,3 cm \_ 38 kg  
70x120xh 3,3 cm \_ 43 kg  
70x140xh 3,3 cm \_ 51 kg  
70x160xh 3,3 cm \_ 58 kg  
70x170xh 3,3 cm \_ 65 kg  
70x180xh 3,3 cm \_ 72 kg  
80x100xh 3,3 cm \_ 42 kg  
80x120xh 3,3 cm \_ 50 kg  
80x140xh 3,3 cm \_ 57 kg  
80x160xh 3,3 cm \_ 64 kg  
80x170xh 3,3 cm \_ 71 kg  
80x180xh 3,3 cm \_ 78 kg

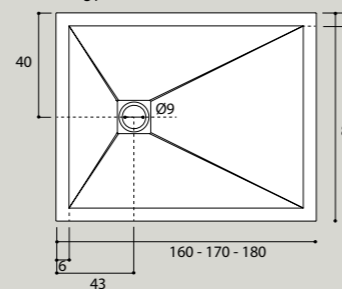
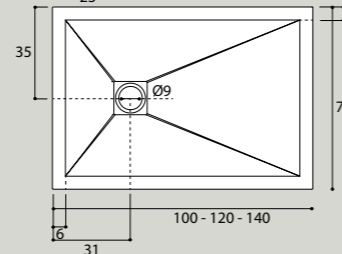
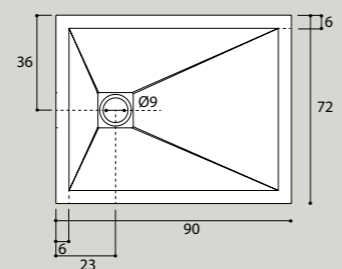

ATTENZIONE:  
le misure indicate possono subire una tolleranza  $\pm 3$  mm. Verificarle in fase di installazione

The sizes listed can have a tolerance of  $\pm 3$  mm. Check the shower tray size before installation

## caratteristiche tecniche\_technical characteristics

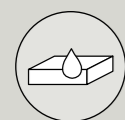

colorato in massa  
pigmented body



pulizia facile  
easy clean



facile al taglio  
easy to cut

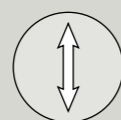

**3,3 cm**  
minimo spessore  
minimum thickness



texture antiscivolo  
non-slip texture



superficie antibatterica  
antibacterial surface

## colori\_colors



bianco  
white



crema  
cream



grigio cemento  
concrete grey



antracite  
anthracite

## griglie\_grates



bianco  
white  
132x132 mm



crema  
cream  
132x132 mm



grigio cemento  
concrete grey  
132x132 mm



antracite  
anthracite  
132x132 mm



acciaio inox  
stainless steel  
132x132 mm

## piletta\_waste

H 6



Piletta di scarico con copertura in acciaio inox per piatti doccia in marmo resina.

Waste trap cover in stainless steel for marble-resin shower trays.

## dettagli\_details



Dettaglio del fondo liscio sottostante del piatto doccia in marmo resina H 3,3 cm.

Detail of the smooth underside of the marble-resin shower trays H 3,3 cm





Flat/Bordo  
80x140 cm



Questi piatti garantiscono elevate prestazioni tecniche, igiene e resistenza grazie al materiale in marmo resina dalla superficie antiscivolo, che si contraddistingue per la sua durezza e piacevolezza al tatto.

These shower trays offer technical high performance, hygiene and are resistant to damage thanks to the marble-resin construction and anti-slip stone effect finish. The finish is sturdy and pleasant to the touch.



Flat/Bordo  
80x100 cm

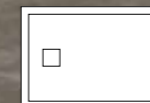



L'acqua scivola sulla superficie  
materica e piacevole al tatto dei  
piatti doccia in marmo resina.

The marble resin shower tray  
permits the water to slide  
effortlessly on the material  
and is pleasant to the touch.



Flat/Bordo  
80x140 cm

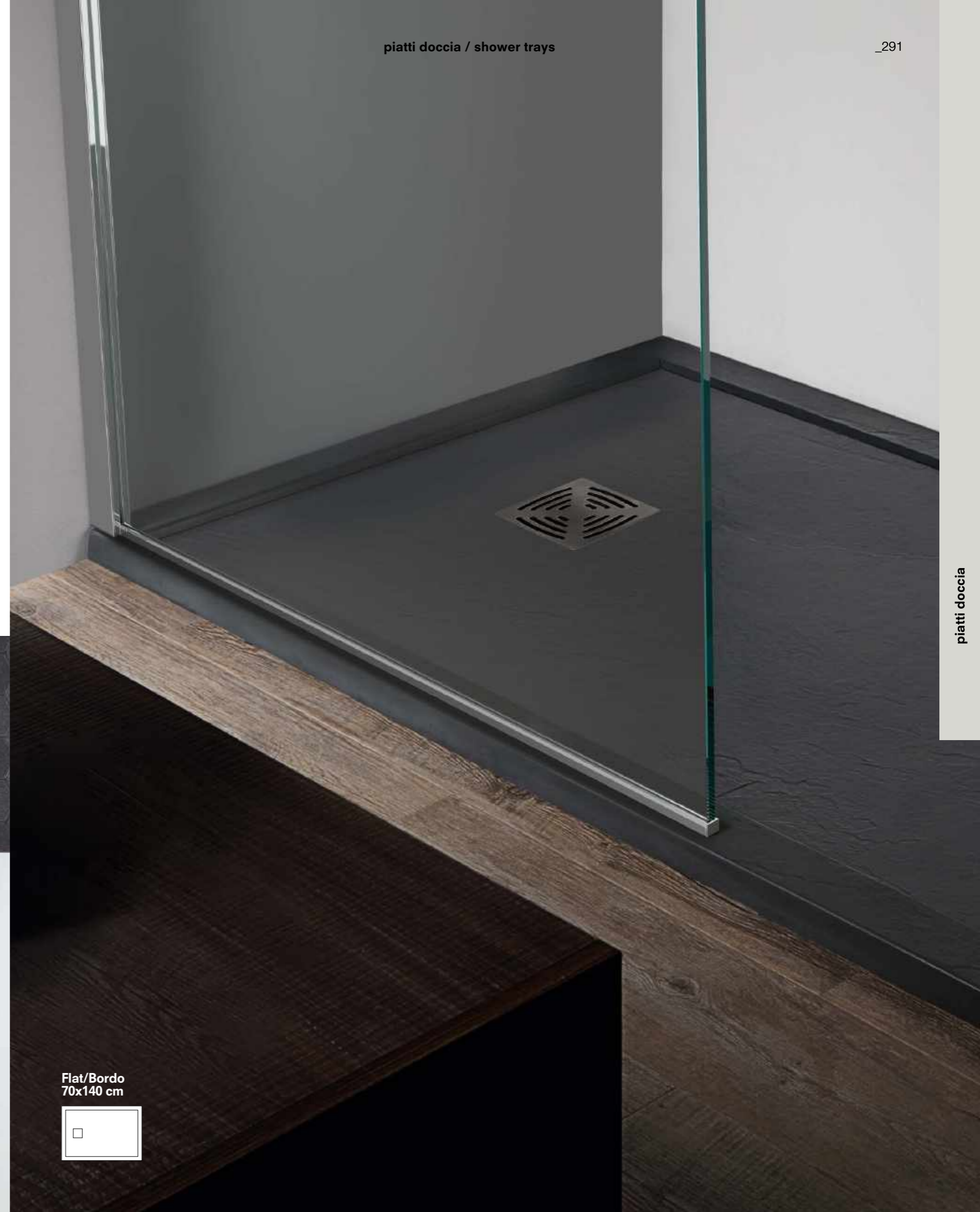
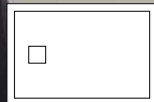

Flat/Bordo  
70x140 cm

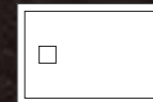

# SMC

## Polyester ECO

Piatto doccia ECO completo di piletta di scarico.

ECO shower tray with waste trap.

### versioni\_versions

Quadrato  
Square

80x80xh 2,5 cm \_ 10 kg  
90x90x h 2,5 cm \_ 11 kg

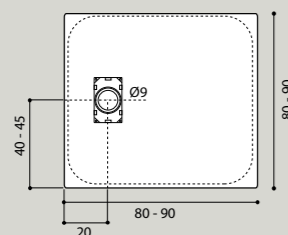

Rettangolare  
Rectangular

72x90xh 2,5 cm \_ 10 kg  
70x100xh 2,5 cm \_ 12 kg  
70x120xh 2,5cm \_ 13 kg  
80x100xh 2,5 cm \_ 11 kg  
80x120xh 2,5 cm \_ 13 kg  
80x140xh 2,5 cm \_ 15 kg  
90x120xh 2,5 cm \_ 16 kg  
90x140xh 2,5 cm \_ 17 kg

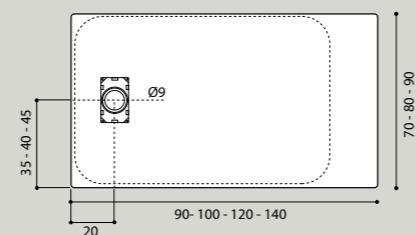

L'innovazione principale dei piatti doccia della Serie ECO è la sua estrema leggerezza dato dal materiale utilizzato, l'SMC un materiale in poliestere rinforzato con fibre di vetro, un prodotto più resistente del marmo, ma meno fragile e più facile da posizionare, in ogni forma e dimensione.

The main innovation of the ECO Series shower trays is its extreme lightness given by the material used, SMC is a polyester material reinforced with fiberglass, a product more resistant than marble, but less fragile and easier to position, in every shape and size.

#### I VANTAGGI:

- Rende facile il trasporto e la messa in posa;
- Semplifica lo stoccaggio merci;
- Facilita la gestione del magazzino;
- Consente di ottimizzare i costi di spedizione.

#### THE ADVANTAGES:

- It makes transport and installation easy;
- Simplifies goods storage;
- Streamlines warehouse management;
- Helps optimize shipping costs.

### caratteristiche tecniche\_technical characteristics



pulizia facile  
easy clean

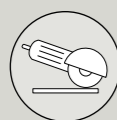

facile al taglio  
easy to cut



2,5 cm

minimo spessore  
minimum thickness



texture antiscivolo  
non-slip texture



resistenza agli urti  
resistant to shock



piacevole al tatto  
pleasant to the touch



estremamente leggero  
extremely light

### colori\_colors



bianco  
white

### dettagli\_details

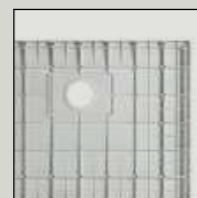

Grigliato sottostante del piatto doccia in poliestere.

Grid underneath the polyester shower tray.

### piletta\_waste



Piletta di scarico per i piatti doccia in SMC Polyester ECO.

Waste trap for SMC Polyester ECO shower trays.

H 8

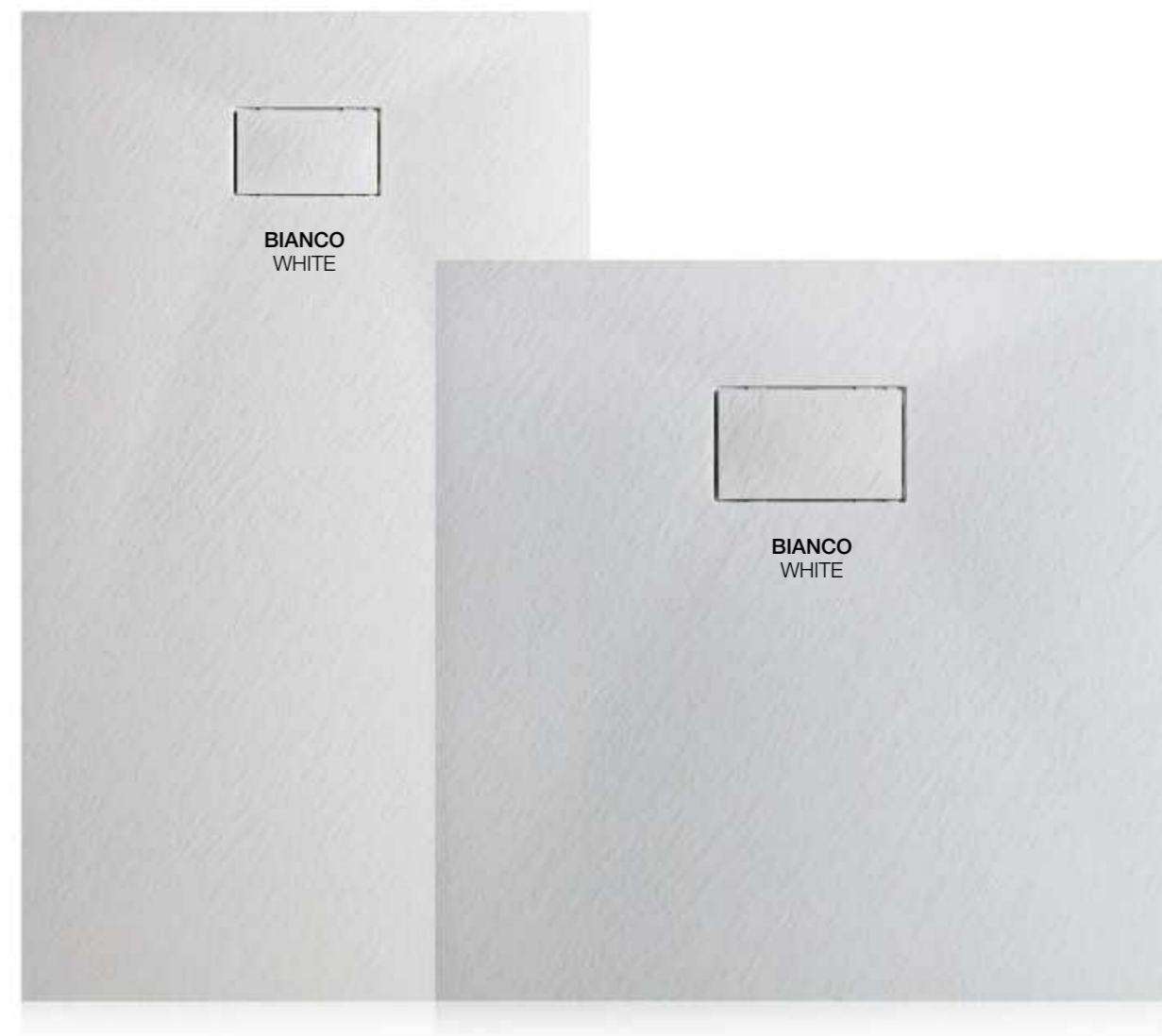



SMC Polyester ECO  
90x90 cm



SMC Polyester ECO  
80x120 cm



Piatto doccia in SMC, un materiale in poliestere rinforzato con fibre di vetro. Materia riciclabile e resistente alla corrosione, più resistente del marmo e dei prodotti acrilici. Leggero e colorato in massa.

Shower tray in SMC, it is a polyester material which is reinforced with fiberglass. It is totally recyclable and resistant to corrosion, it is stronger than marble or acrylic products. It is light and the pigmentation is in the body of the material.

# Acrylic H3

## (lucido & velvet)

Piatto doccia in acrilico  
completo di piletta di scarico.

Acrylic shower tray  
complete with waste trap.

### versioni\_versions

Quadrato  
Square

80x80xh 3 cm \_ 6,5 kg  
90x90x h 3 cm \_ 8 kg  
100x100x h 3 cm \_ 10 kg

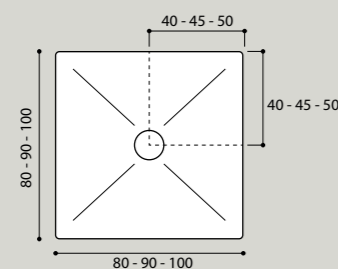

Angolare  
Corner

80x80xh 3 cm \_ 6 kg  
90x90x h 3 cm \_ 8 kg  
100x100x h 3 cm \_ 9 kg

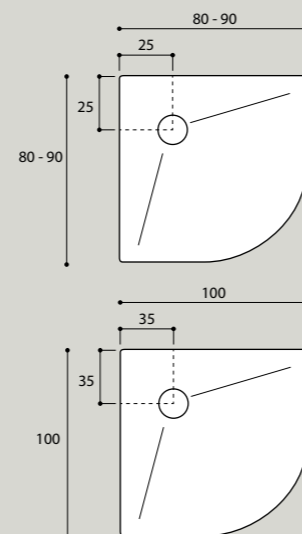

Rettangolare  
Rectangular

72x90xh 3 cm \_ 8 kg  
70x100xh 3 cm \_ 8,5 kg  
70x120xh 3 cm \_ 9,5 kg  
70x140xh 3 cm \_ 10,5 kg  
70x160xh 3 cm \_ 11,5 kg  
70x170xh 3 cm \_ 12,5 kg  
80x100xh 3 cm \_ 9 kg  
80x120xh 3 cm \_ 11 kg  
80x140xh 3 cm \_ 15 kg  
80x160xh 3 cm \_ 17 kg  
80x170xh 3 cm \_ 18 kg

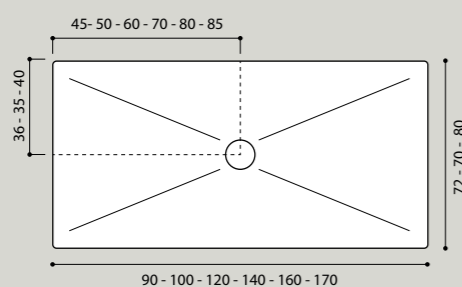

### caratteristiche tecniche\_technical characteristics



pulizia facile  
easy clean



superficie antibatterica  
antibacterial surface

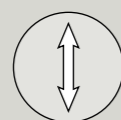

**3 cm**  
minimo spessore  
minimum thickness



piacevole al tatto  
pleasant to the touch

### colori\_colors



bianco lucido  
white glossy



bianco velvet  
white velvet

### dettagli\_details



Rinforzo del legno  
e vetroresina.

Wood and fibreglass  
reinforcement.

### piletta\_waste



Piletta di scarico per i  
piatti doccia in acrilico.

Waste trap for acrylic  
shower trays.

H 6





Acrylic Velvet H3  
100x100 cm

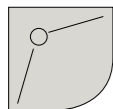

I formati proposti e le colorazioni Velvet creano spazi architettonicamente risolti in chiave moderna e minimale.

The proposed shaped and Velvet colours create spaces that are architecturally resolved in modern and minimalistic interpretation.



Il piatto doccia in ACRILICO RINFORZATO posteriormente con un composto di acrilico, legno e fibre di vetro. Ideale per spazi doccia o nicchie di grandi dimensioni, per installazioni in appoggio e a filo pavimento.

A view of the reinforced acrylic shower tray section with acrylic, wood and fiberglass. This is ideal for shower stalls, or niche areas; it can be installed on top of the flooring or flush.



Acrylic Velvet H3  
70x120 cm

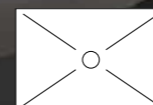



Acrylic Lucido H3  
100x100 cm

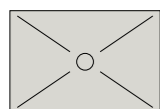



# Acrylic H5/Bordo

## (lucido & velvet)

Piatto doccia in acrilico completo di piletta di scarico. Acrylic shower tray complete with waste trap.

### versioni\_versions

#### Quadrato Square

80x80xh 5 cm \_ 8,5 kg  
90x90x h 5 cm \_ 10 kg  
100x100x h 5 cm \_ 14 kg

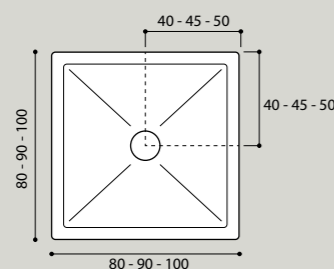

#### Rettangolare Rectangular

72x90xh 5 cm \_ 10 kg  
70x100xh 5 cm \_ 10,5 kg  
70x120xh 5 cm \_ 11,5 kg  
70x140xh 5 cm \_ 12,5 kg  
70x160xh 5 cm \_ 13,5 kg  
70x170xh 5 cm \_ 14,5 kg  
80x100xh 5 cm \_ 11 kg  
80x120xh 5 cm \_ 13 kg  
80x140xh 5 cm \_ 17 kg  
80x160xh 5 cm \_ 19 kg  
80x170xh 5 cm \_ 22 kg

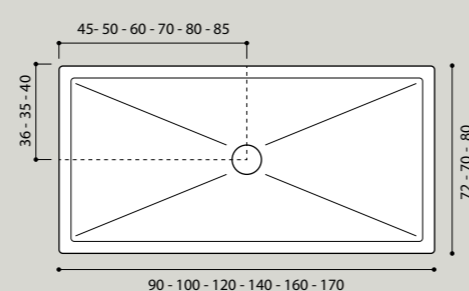

### caratteristiche tecniche\_technical characteristics



pulizia facile  
easy clean



superficie antibatterica  
antibacterial surface

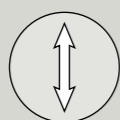

**5 cm**  
minimo spessore  
minimum thickness

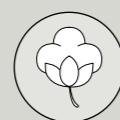

piacevole al tatto  
pleasant to the touch

### colori\_colors



bianco lucido  
white glossy



bianco velvet  
white velvet

### dettagli\_details



Rinforzo del legno  
e vetroresina.

Wood and fibreglass  
reinforcement.

### piletta\_waste



Piletta di scarico  
per i piatti doccia  
in acrilico.

Waste trap for  
acrylic shower trays.





Acrylic H5/Bordo  
80x160 cm

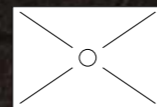

Questo modello in acrilico toglie qualsiasi indecisione legata alla paura di fuoriuscita dell'acqua ed è disponibile nei formati quadrato e rettangolare.

—  
This acrylic shower tray offers water-tight installation. Available in rectangular and square shapes.



Acrylic H5/Bordo  
80x80 cm

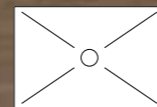

# Pannelli rivestimento

## Wall Covering Panels

### versioni\_versions

Rettangolare  
Rectangular

80x70x0,6 cm \_ 2 kg  
80x90x0,6 cm \_ 2,5 kg  
200x90x0,6 cm \_ 5 kg  
200x70x0,6 cm \_ 6 kg

Necessiti di eseguire la sostituzione della vasca con una doccia nuova? Il nostro ufficio tecnico trasforma la vasca da bagno in un box doccia elegante, sicuro e facilmente accessibile, anche senza l'obbligo delle piastrelle dei muri e dei pavimenti ma con l'aiusilio di pannelli di rivestimento in acrilico. I pannelli vengono applicati a filo delle piastrelle superiori oppure in sovrapposizione.

Do you need to replace a bathtub with a new shower enclosure? Our technical office can transform the bathtub into an elegant, safe and easily accessible shower. This conversion can be carried out without having to tile the wall or flooring but by using the wall covering panels and shower tray. The wall panels can be applied directly on the bathroom wall and also on the tiled wall.

### caratteristiche tecniche\_technical characteristics



pulizia facile  
easy clean



superficie antibatterica  
antibacterial surface



scorrimento veloce acqua  
fast water flow



piacevole al tatto  
pleasant to the touch



facile al taglio  
easy to cut

### colori\_colors



bianco lucido  
white glossy



bianco velvet  
white velvet

### dettagli\_details

- Incollaggio a parete con normale silicone antimuffa.
- Facile adattabilità.
- Profilo di chiusura taglio in dotazione.
- Abbinabili con qualsiasi piatto doccia in acrilico.

- Wall bonding with normal antimould silicone.
- Easy adaptability.
- Closing cutting profile supplied.
- Matched with any acrylic shower tray.

**prima**

BEFORE



**dopo**

AFTER



piatti doccia

**PANNELLI DA MURO**  
- Due pannelli di fondo in acrilico,  
H 700 mm spessore 6 mm

**WALL PANELS**  
- Two base panels in acrylic,  
H 700 mm thickness 6 mm

**PIATTO DOCCIA**  
- Acrilico H 90 mm  
- Piletta di scarico centrale

**SHOWER TRAY**  
- Acrylic H 90 mm  
- Central waste trap



Wall Covering Panels



Wall Covering Panels



È possibile trasformare la vostra vecchia vasca da bagno in una comoda e funzionale cabina doccia. I nostri materiali sono di alta qualità per rendere il prodotto sempre più all'avanguardia.

It is possible to convert your old bathtub into an elegant, safe and easily accessible shower. Our materials are of high quality in order to offer a state-of-the-art product.

# colonne doccia

shower columns

---

## colonne doccia

shower columns

---

LOIRA	<u>312</u>
SENNÀ	<u>314</u>
RIO	<u>316</u>
DANUBIO	<u>318</u>
VOLGA	<u>320</u>
PO	<u>322</u>
PRETORIA	<u>324</u>
NETTUNO	<u>326</u>
GAIA	<u>328</u>
SET QUADRO	<u>330</u>
RIPETTA	<u>332</u>
SIRENA	<u>334</u>
DIANA	<u>336</u>
SET TONDO	<u>338</u>
ANGELICA	<u>340</u>
SET RETTANGOLARE BLACK	<u>342</u>
TRITONE	<u>344</u>
SET TONDO BLACK	<u>346</u>

# Loira

## caratteristiche\_characteristics

### COLONNA DOCCIA

- Soffione doccia integrato
- Idrogetti
- Deviatore
- Miscelatore meccanico
- Doccetta a due vie
- Portashampoo
- Dispenser sapone

### SHOWER COLUMN

- Head shower
- Jets
- Diverter
- Mechanical mixer
- Hand shower with diverter
- Shampoo shelf
- Soap dispenser



## colori\_colors



## dettagli\_details

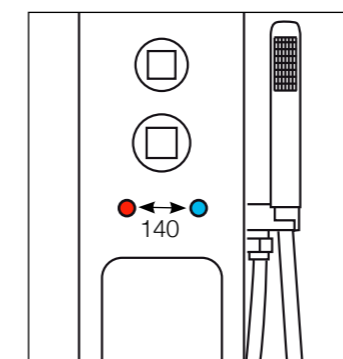
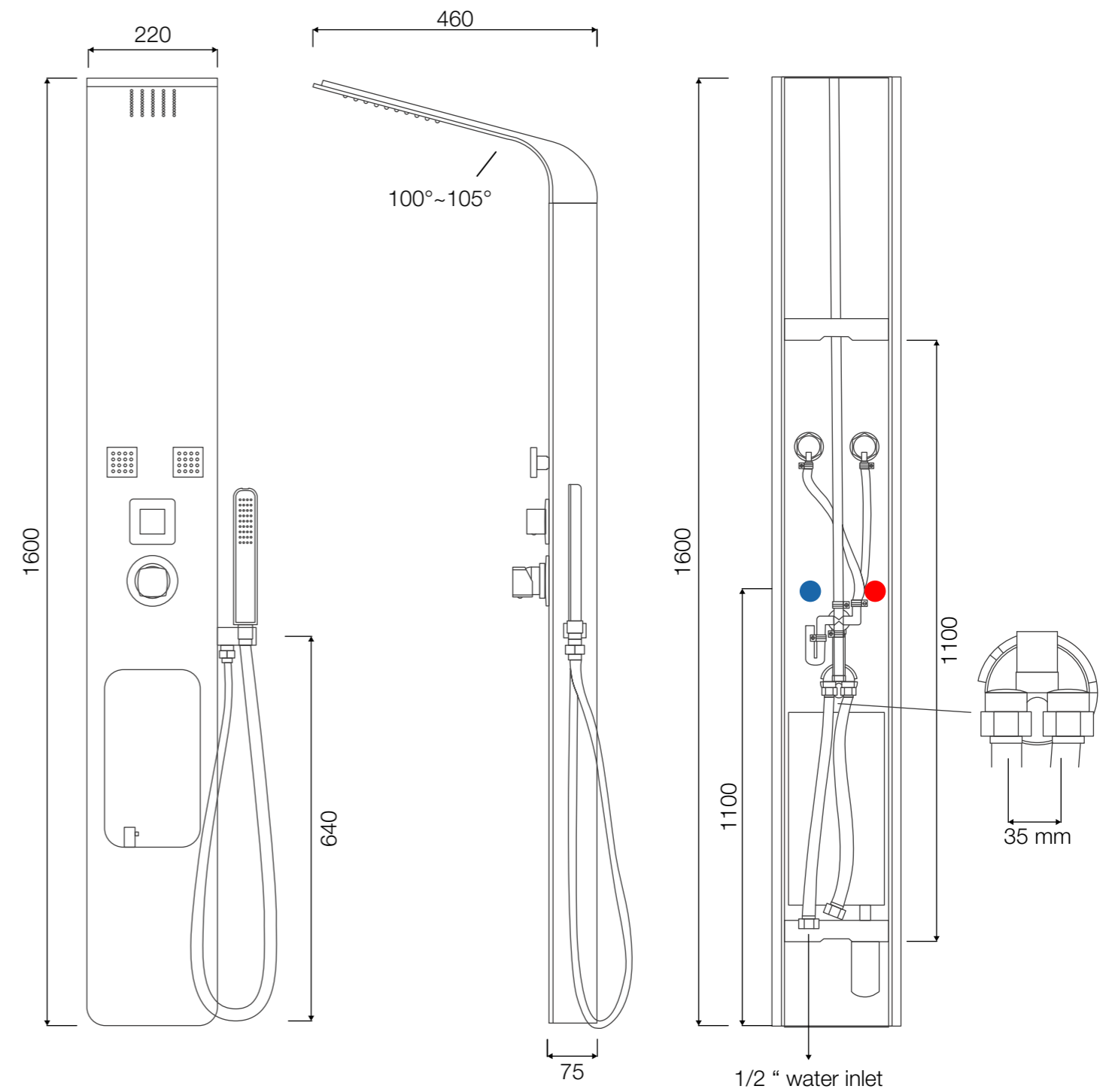

Attacchi acqua calda e fredda  
Hot and cold water connections

# Senna

## caratteristiche\_characteristics

### COLONNA DOCCIA

- Soffione doccia integrato
- Lama d'acqua a cascata
- Deviatore
- Miscelatore meccanico
- Doccetta

### SHOWER COLUMN

- Head shower
- Water fall shower
- Diverter
- Mechanical mixer
- Hand shower



## colori\_colors



bianco  
white



silver  
silver

## dettagli\_details

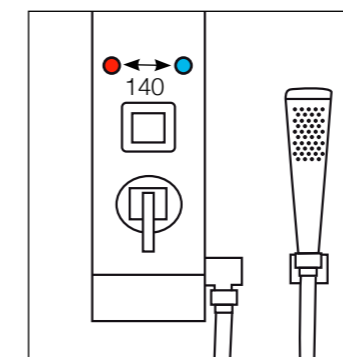
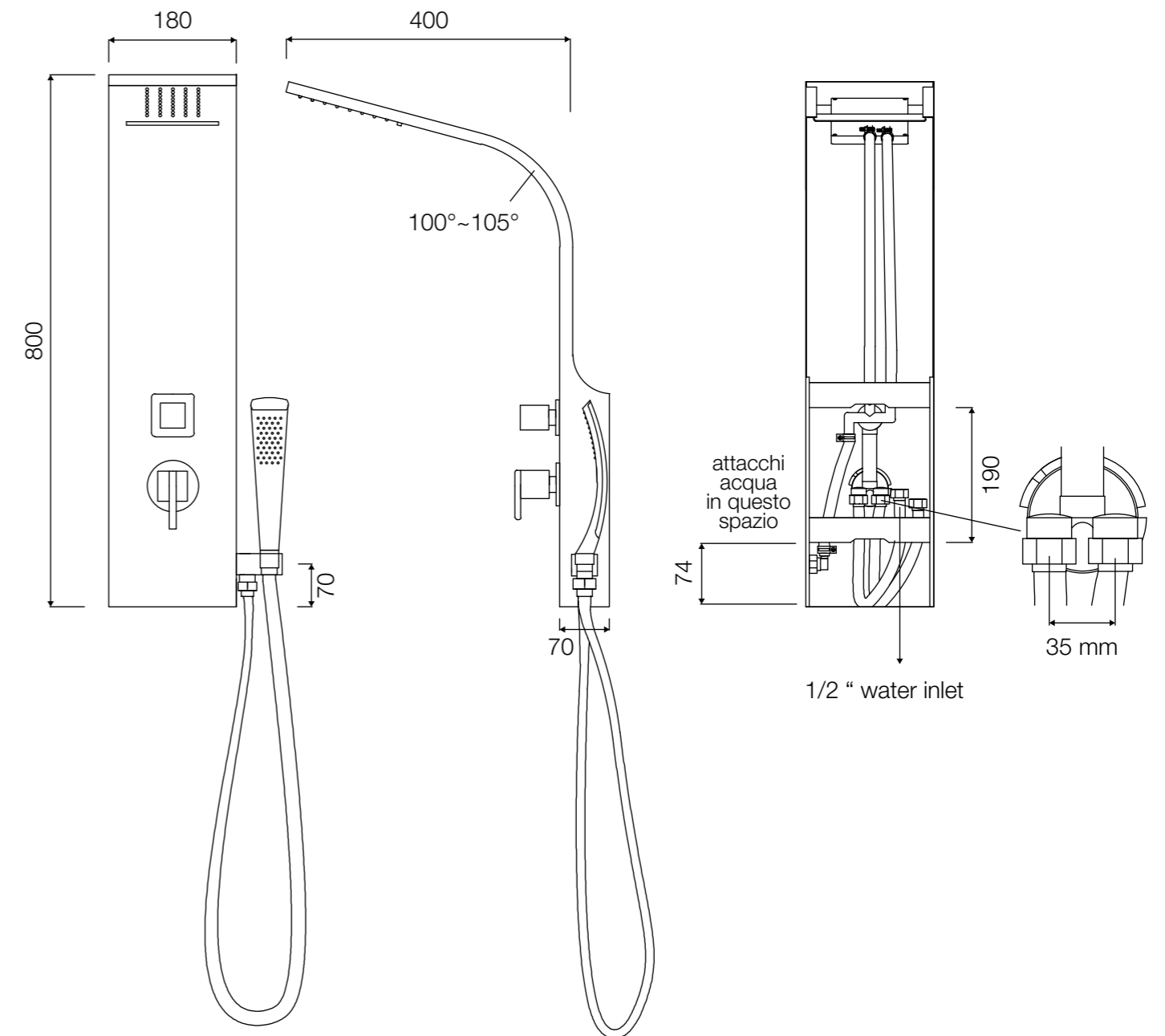

Attacchi acqua calda e fredda  
Hot and cold water connections

# Rio

## caratteristiche\_characteristics

### COLONNA DOCCIA

- Soffione doccia integrato
- Miscelatore meccanico
- Portashampoo
- Deviatore
- Doccetta a due vie

### SHOWER COLUMN

- Head shower
- Mechanical mixer
- Shampoo shelf
- Diverter
- Hand shower with diverter



## colori\_colors



specchiato  
mirrored



spazzolato  
brushed

## dettagli\_details

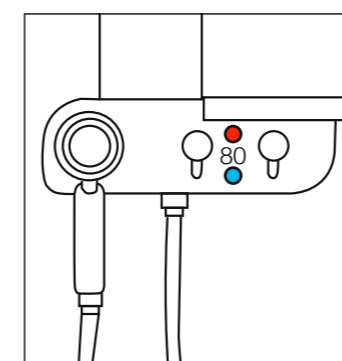
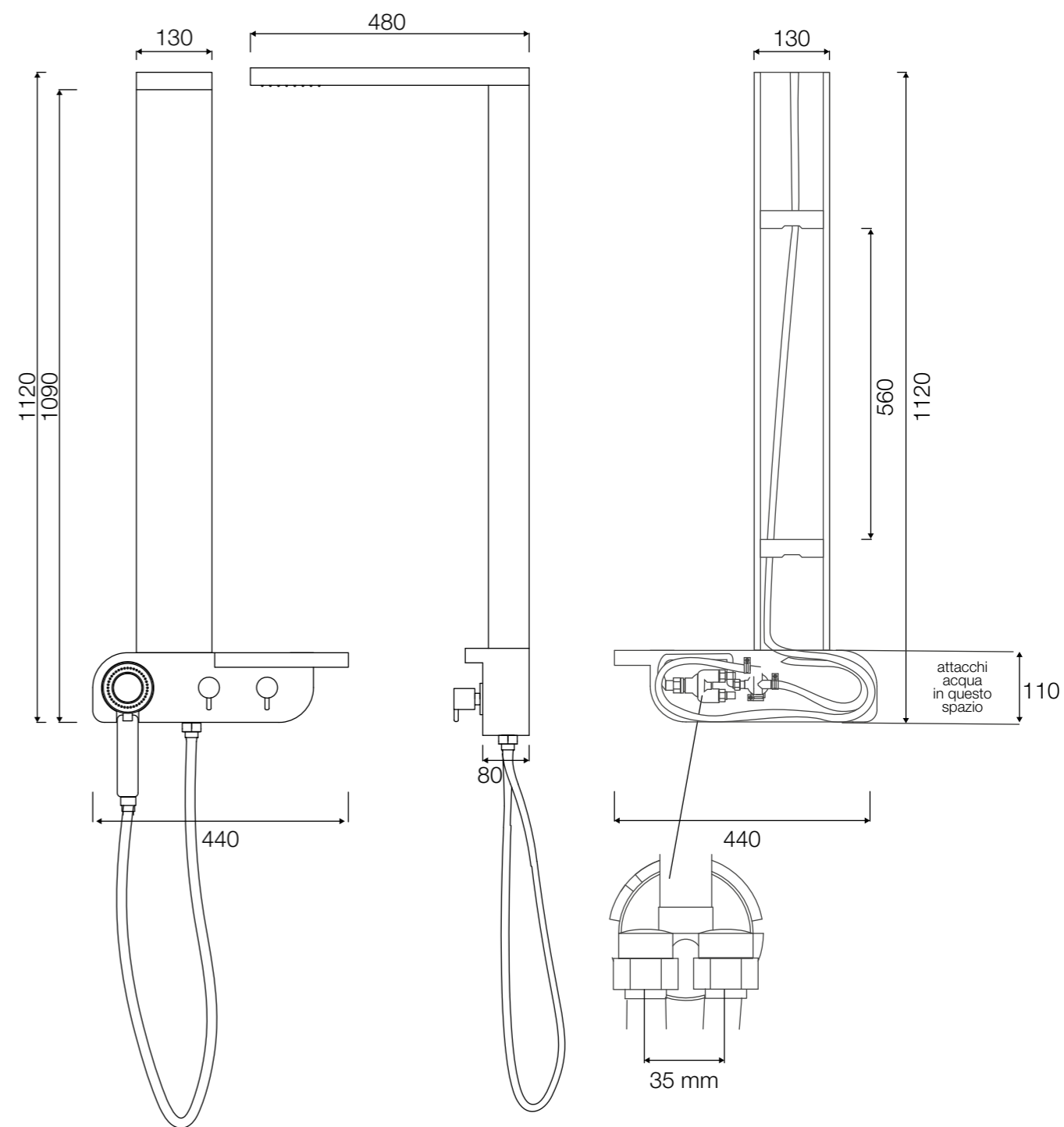

Attacchi acqua calda e fredda  
Hot and cold water connections



# Danubio

## caratteristiche\_characteristics

- COLONNA DOCCIA  
 - Soffione doccia integrato  
 - Deviatore  
 - Idrogetti  
 - Doccetta  
 - Miscelatore meccanico

- SHOWER COLUMN  
 - Head shower  
 - Diverter  
 - Jets  
 - Hand shower  
 - Mechanical mixer



## colori\_colors



## dettagli\_details

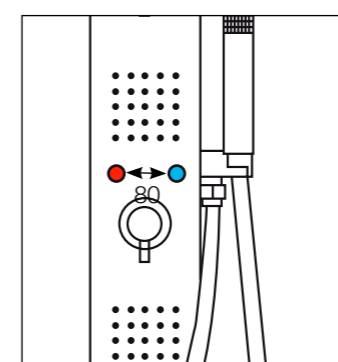
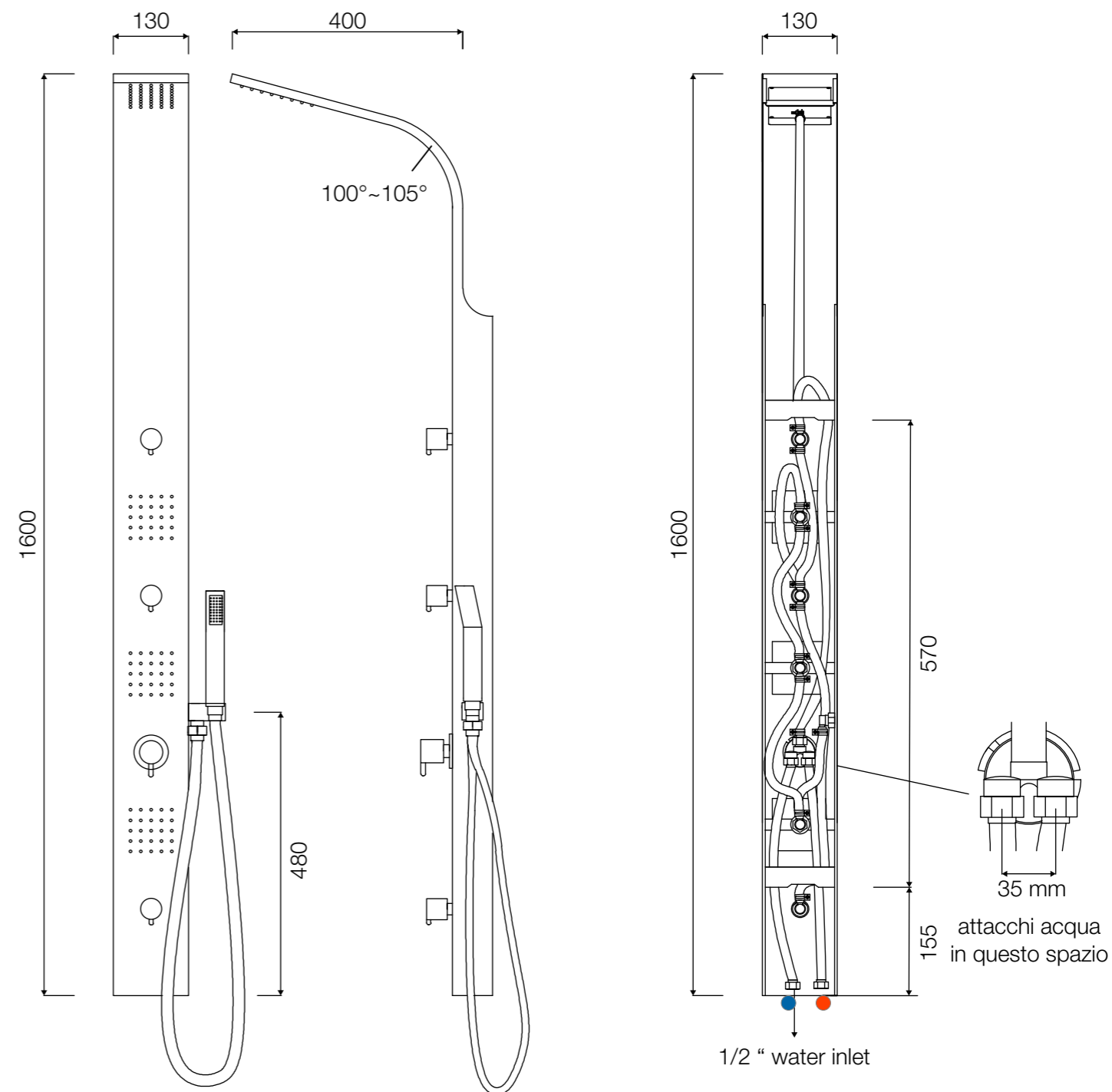

Attacchi acqua calda e fredda  
 Hot and cold water connections

# Volga

## caratteristiche\_characteristics

COLONNA DOCCIA  
 - Soffione doccia integrato  
 - Deviatore  
 - Idrogetti  
 - Doccetta  
 - Miscelatore meccanico

SHOWER COLUMN  
 - Head shower  
 - Diverter  
 - Jets  
 - Hand shower  
 - Mechanical mixer



## colori\_colors

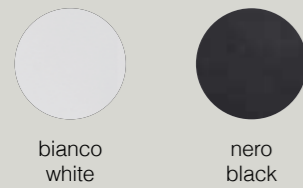

## dettagli\_details

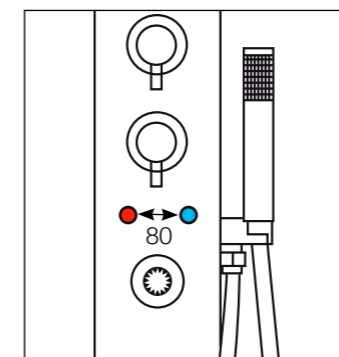
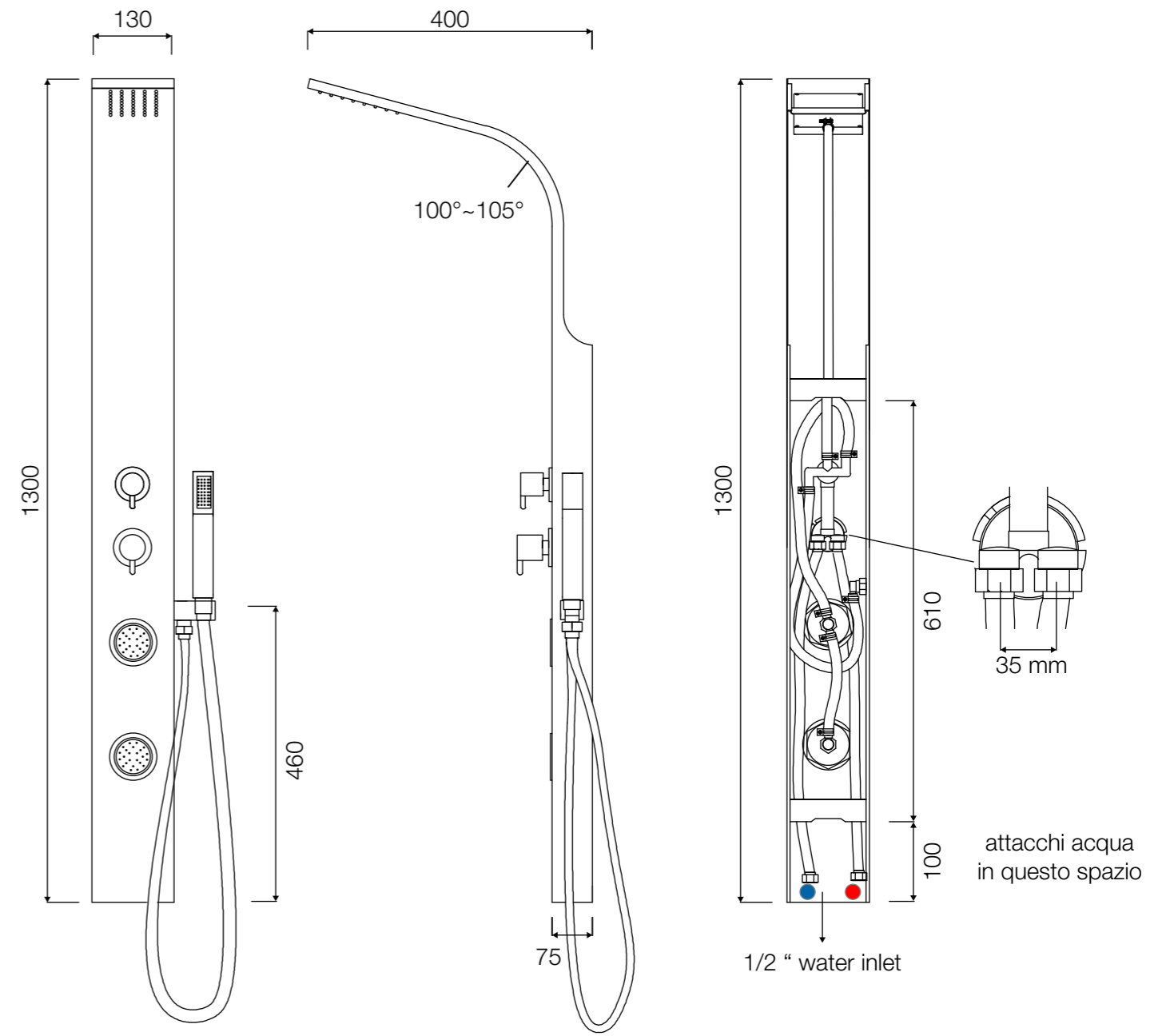
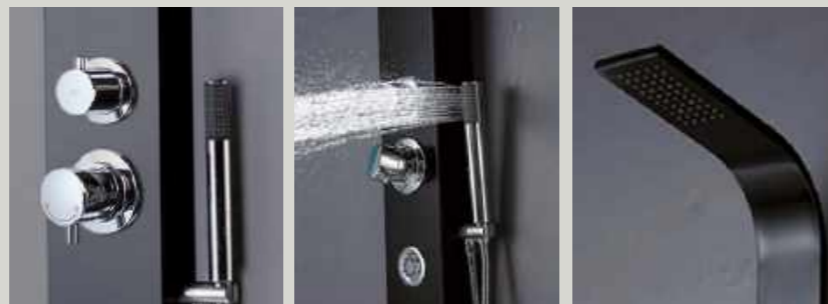

Attacchi acqua calda e fredda  
 Hot and cold water connections

# Po

## caratteristiche\_characteristics

COLONNA DOCCIA  
 - Soffione doccia integrato  
 - Deviatore  
 - Miscelatore  
 - Trattamento antimpronta  
 - Lavapiedi

SHOWER COLUMN  
 - Head shower  
 - Diverter  
 - Mixer  
 - Fingerprint proof finish  
 - Footwasher



## colori\_colors



acciaio spazzolato 316  
 brushed steel 316

## dettagli\_details

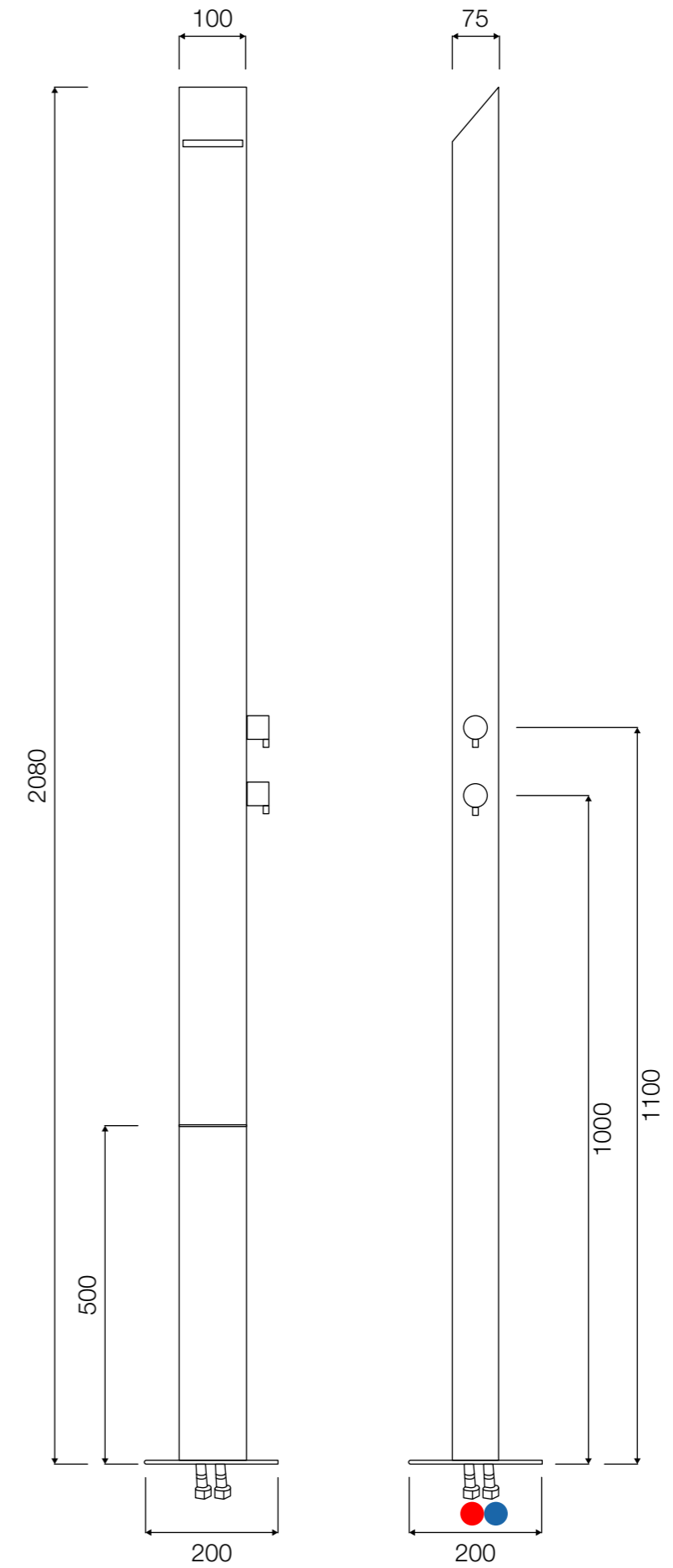

# Pretoria

## caratteristiche\_characteristics

### COLONNA DOCCIA

- Soffione Quadro 20x20 cm  
in acciaio inox spess. 6 mm
- Doccetta in ottone
- Flessibile: 150 cm
- Materiale: Ottone
- Finitura: Cromo
- Colonna doccia regolabile
- Supporto scorrevole in ABS

### SHOWER COLUMN

- Stainless steel rain shower head  
Quadro 20x20 cm, depth 6 mm
- Brass handheld shower head
- Flexible hose: 150 cm
- Material: Brass
- Finish: Chrome
- Adjustable shower column
- Sliding support in ABS



## colori\_colors



cromo  
chrome

## dettagli\_details

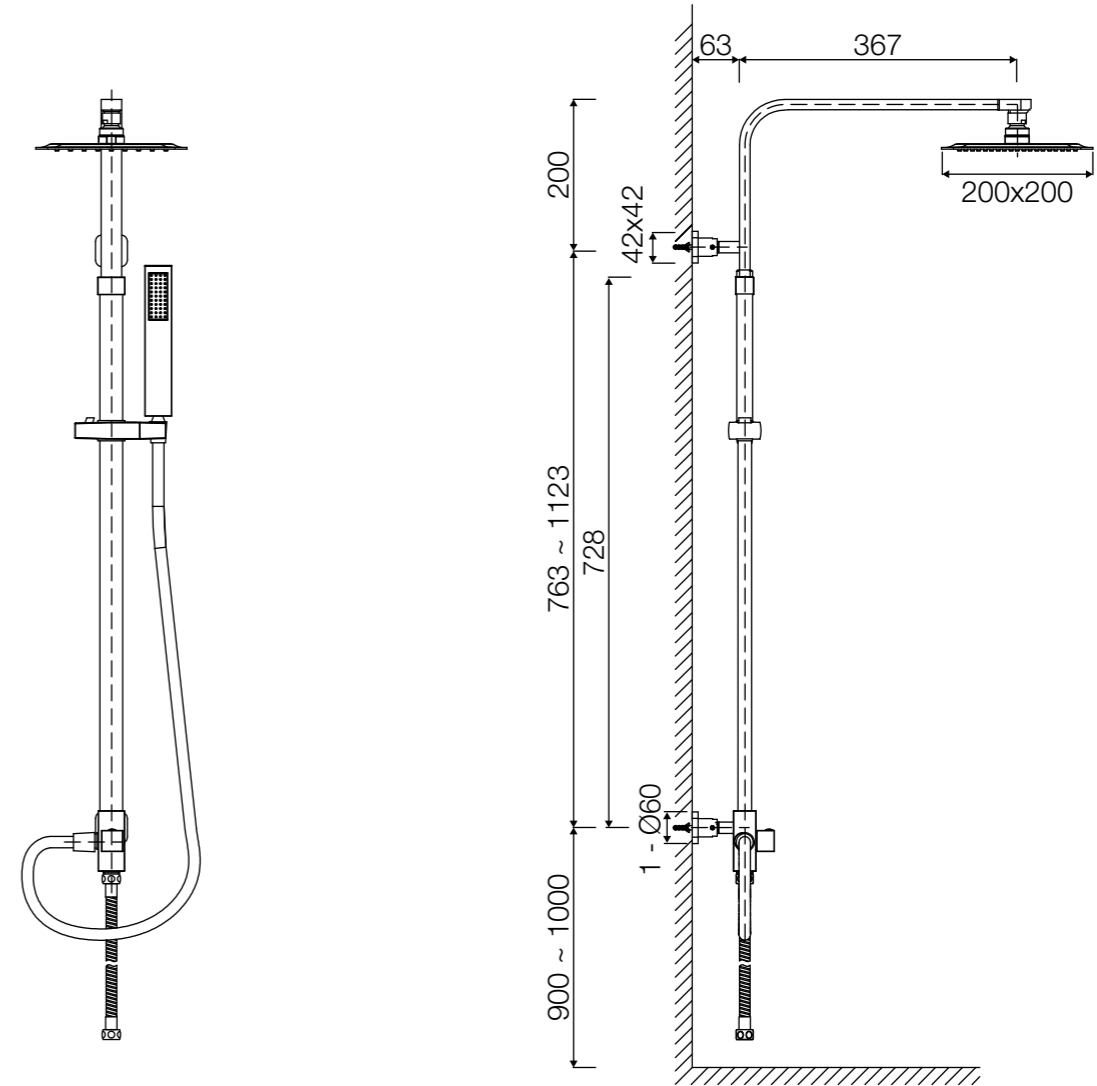

# Nettuno

## caratteristiche\_characteristics

### COLONNA DOCCIA MECCANICA

- Soffione Quadro 25x25 cm  
in acciaio inox spess. 6 mm
- Doccetta in ottone
- Flessibile: 150 cm
- Materiale: Ottone
- Finitura: Cromo
- Colonna doccia regolabile
- Supporto scorrevole in ABS

### MECHANICAL SHOWER COLUMN

- Stainless steel rain shower head  
Quadro 25x25 cm, depth 6 mm
- Brass handheld shower head
- Flexible hose: 150 cm
- Material: Brass
- Finish: Chrome
- Adjustable shower column
- Sliding support in ABS

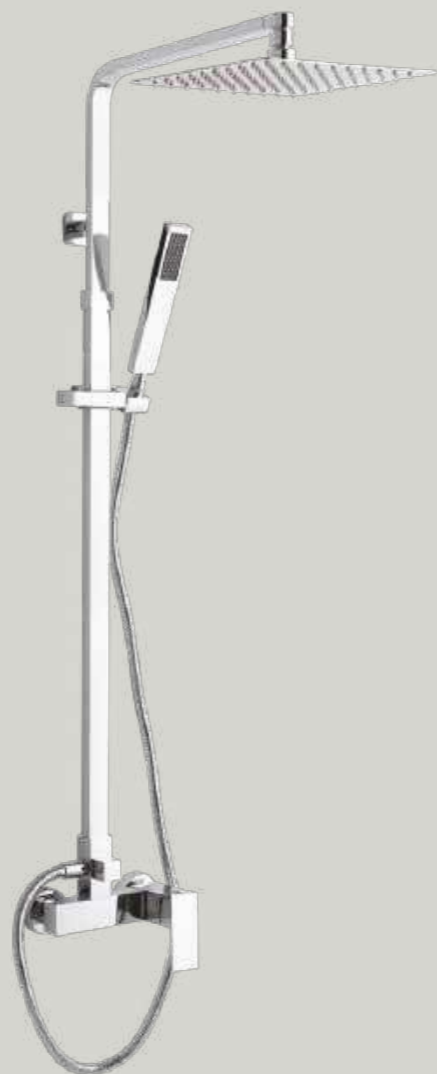

## colori\_colors



cromo  
chrome

## dettagli\_details

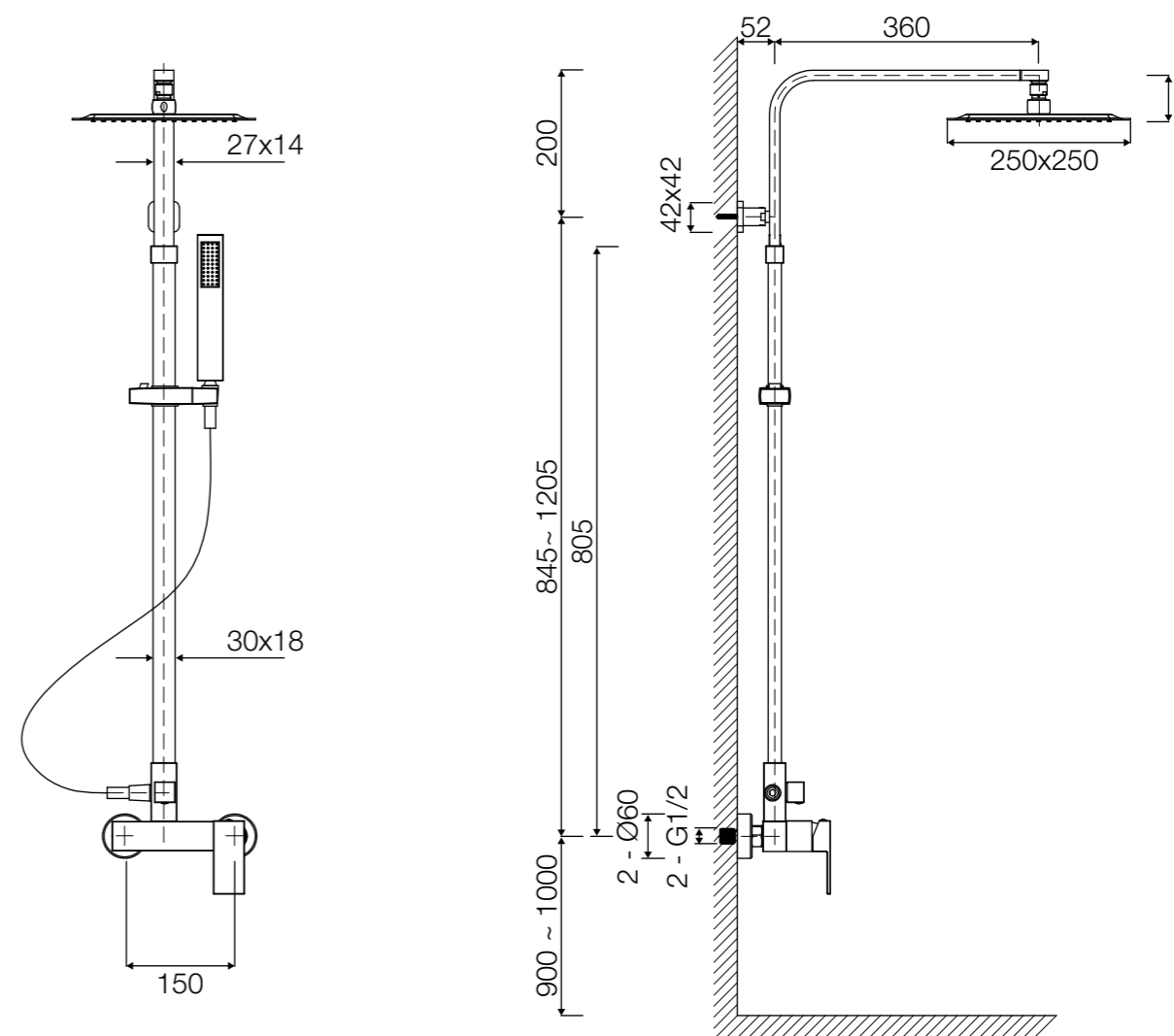

# Gaia

## caratteristiche\_characteristics

### COLONNA DOCCIA TERMOSTATICA

- Soffione Quadro 25x25 cm  
in acciaio inox spess. 6 mm
- Doccetta in ottone
- Flessibile: 150 cm
- Materiale: Ottone
- Finitura: Cromo
- Colonna doccia regolabile
- Supporto scorrevole in ABS

### THERMOSTATIC SHOWER COLUMN

- Stainless steel rain shower  
head Quadro 25x25 cm, depth 6 mm
- Brass handheld shower head
- Flexible hose: 150 cm
- Material: Brass
- Finish: Chrome
- Adjustable shower column
- Sliding support in ABS

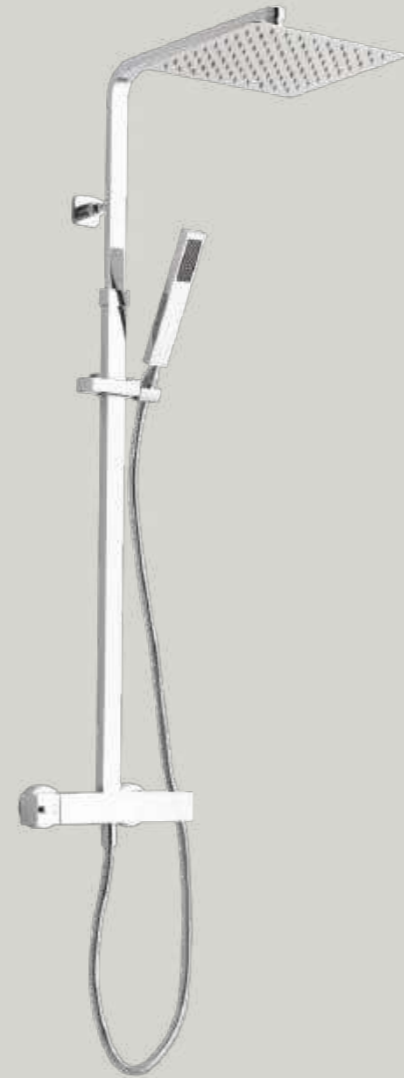

## colori\_colors



cromo  
chrome

## dettagli\_details

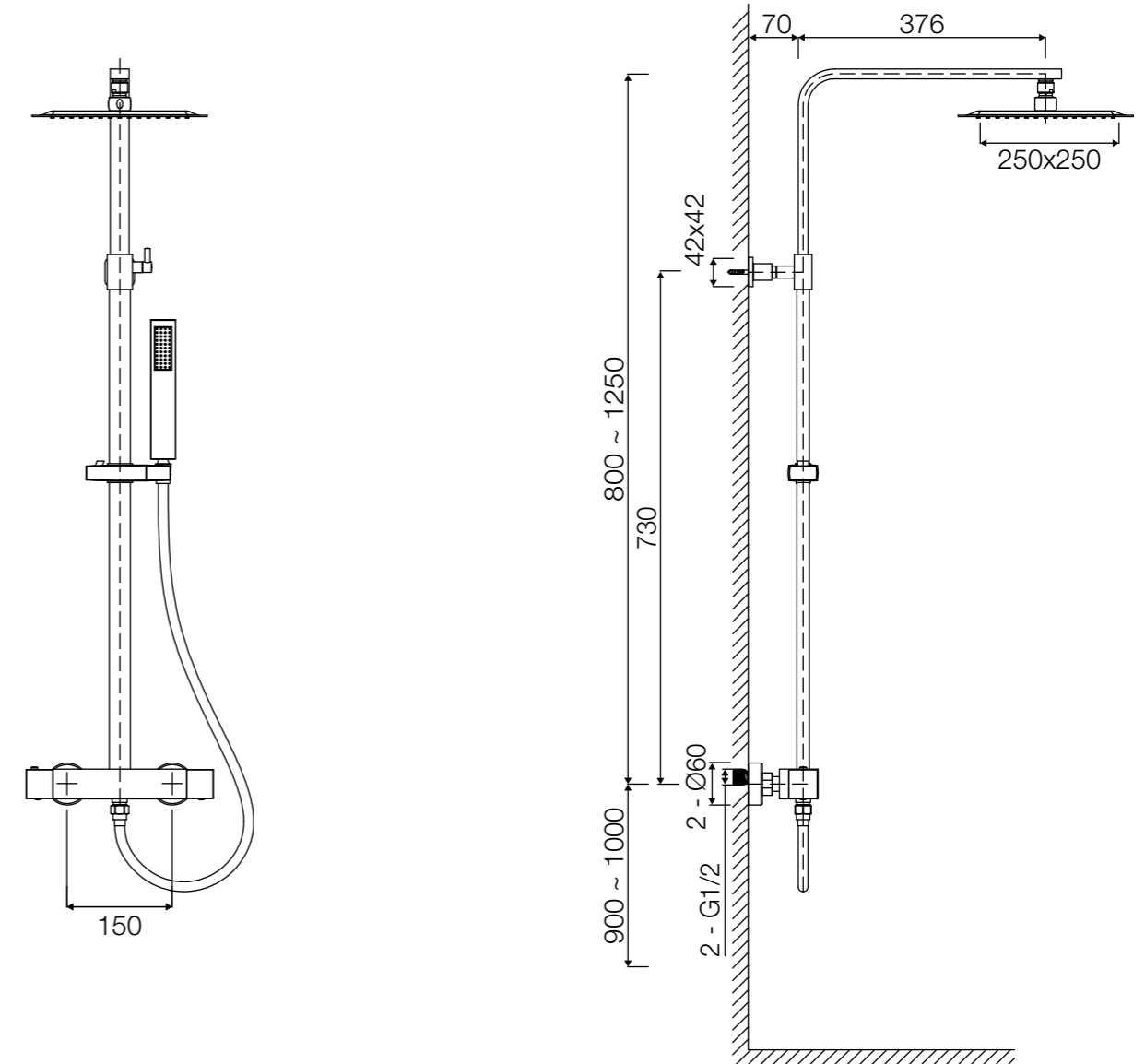

# Set Quadro

## caratteristiche\_characteristics

### SET DOCCIA COMPLETO

- Braccio a muro in ottone 38,3 cm
- Soffione Quadro 20x20 cm in acciaio inox spess. 6 mm
- Incasso doccia in ottone con deviatore a leva
- Doccetta in ottone
- Supporto fisso per doccetta in ottone
- Flessibile: 150 cm
- Materiale: Ottone
- Finitura: Cromo

### COMPLETE SHOWER SET

- Brass wall arm 38,3 cm
- Stainless steel rain shower head Quadro 20x20 cm, depth 6 mm
- Brass built-in mixer with lever diverter
- Brass handheld shower head
- Fixed brass support for handheld shower head
- Flexible hose: 150 cm
- Material: Brass
- Finish: Chrome



## colori\_colors



cromo  
chrome

## dettagli\_details



**HKSO100C**  
Soffione quadro  
Square showerhead  
20x20 cm

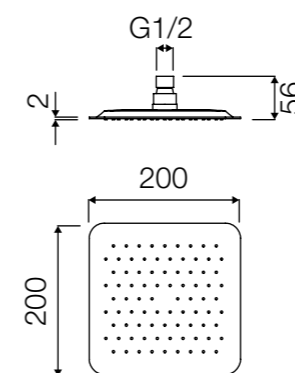

**HKSO101C**  
Soffione quadro  
Square showerhead  
25x25 cm

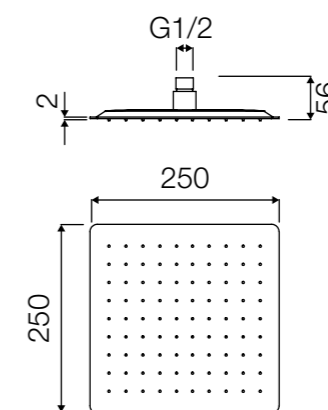

**HKSO102C**  
Soffione quadro  
Square showerhead  
30x30 cm

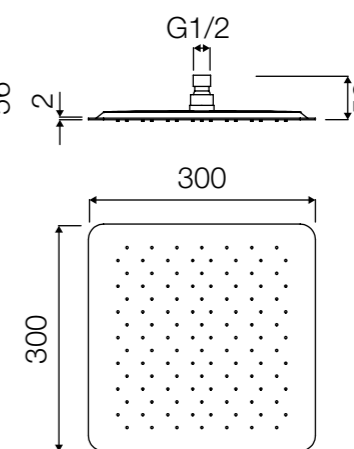

**HKDOC130C**  
Doccetta quadra  
Square handheld showerhead

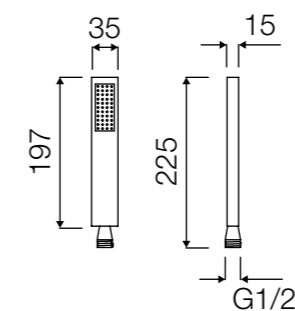

**HKSUP120C**  
Supporto doccetta quadro  
Square handheld showerhead holder

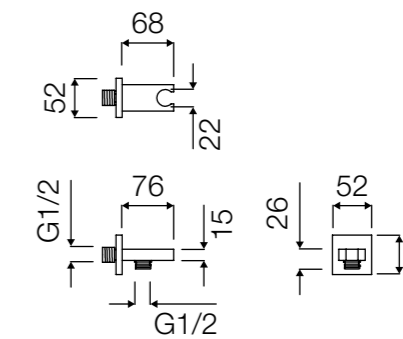

**HKAST110C**  
Asta a muro quadra  
Square wall-mounted shower arm

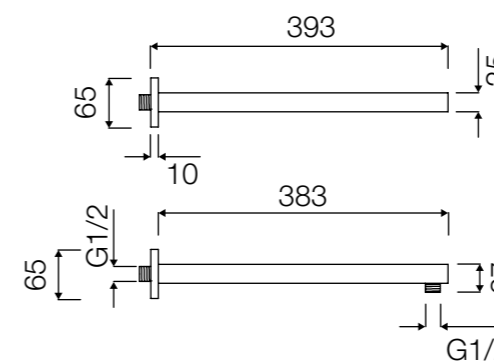

**HKINC142C**  
Incasso doccia quadro  
Recessed square shower control

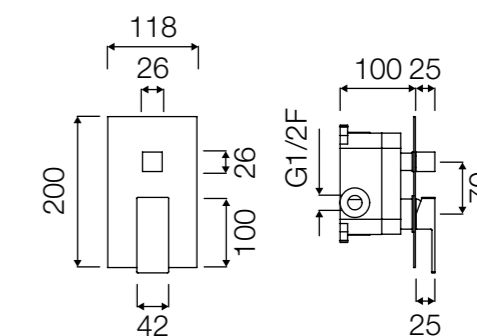

# Ripetta

## caratteristiche\_characteristics

### COLONNA DOCCIA

- Soffione Tondo Ø 20 cm  
in acciaio inox spess. 7,5 mm
- Doccetta in ABS
- Flessibile: 150 cm
- Materiale: Ottone
- Finitura: Cromo
- Colonna doccia regolabile
- Supporto scorrevole in ABS

### SHOWER COLUMN

- Stainless steel rain shower head  
Tondo Ø 20 cm, depth 7,5 mm
- ABS handheld shower head
- Flexible hose: 150 cm
- Material: Brass
- Finish: Chrome
- Adjustable shower column
- Sliding support in ABS



## colori\_colors



cromo  
chrome

## dettagli\_details

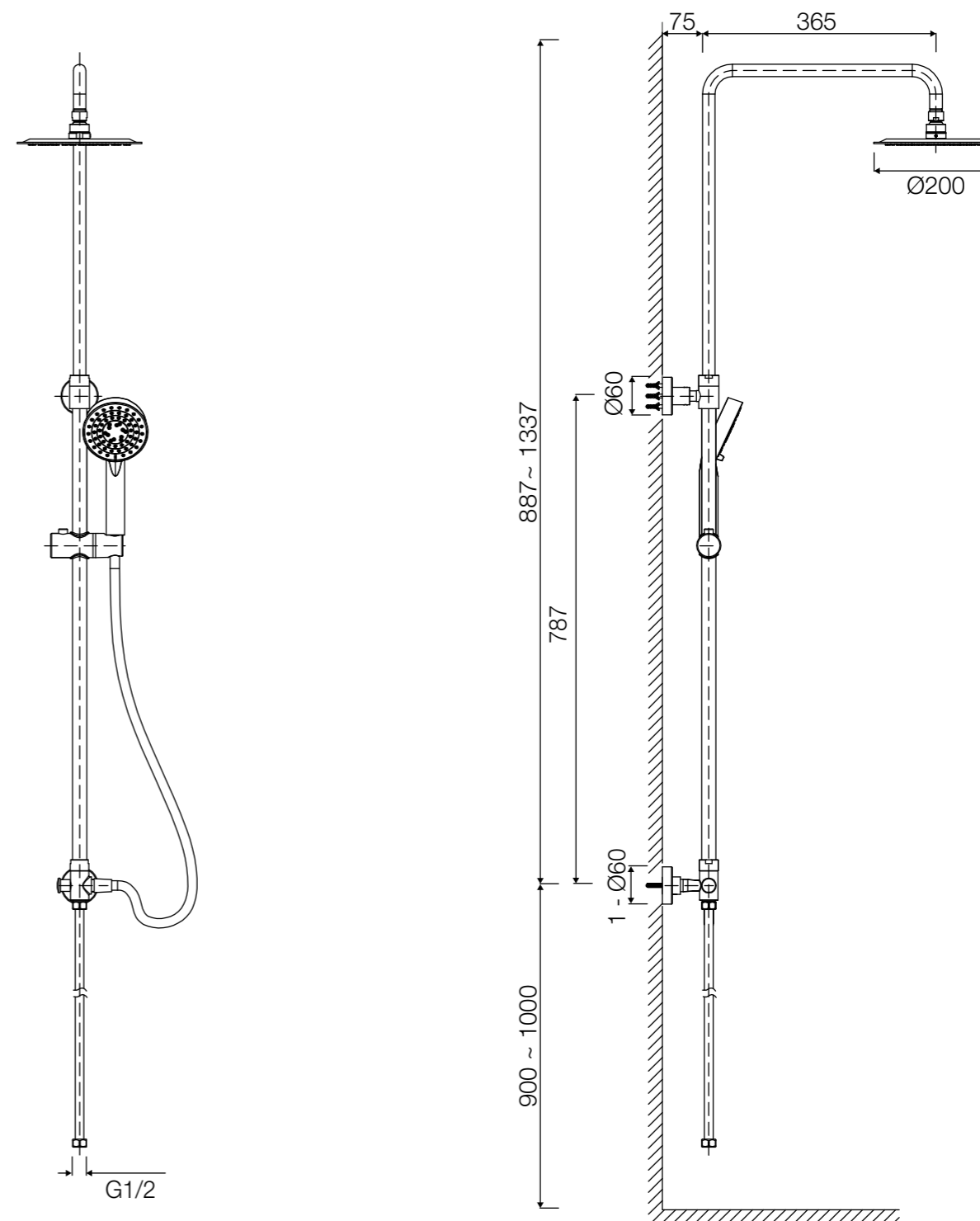
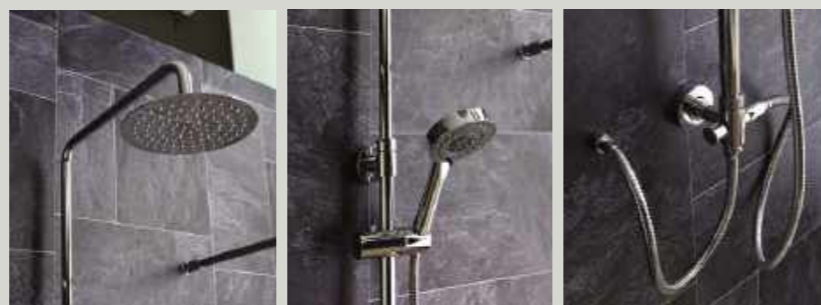



# Sirena

## caratteristiche\_characteristics

COLONNA DOCCIA MECCANICA  
 - Soffione Tondo Ø 20 cm  
 in acciaio inox spess. 7,5 mm  
 - Doccetta in ABS  
 - Flessibile: 150 cm  
 - Materiale: Ottone  
 - Finitura: Cromo  
 - Colonna doccia regolabile  
 - Supporto scorrevole in ABS

MECHANICAL SHOWER COLUMN  
 - Stainless steel rain shower head  
 Tondo Ø 20 cm, depth 7,5 mm  
 - ABS handheld shower head  
 - Flexible hose: 150 cm  
 - Material: Brass  
 - Finish: Chrome  
 - Adjustable shower column  
 - Sliding support in ABS



## colori\_colors



cromo  
chrome

## dettagli\_details

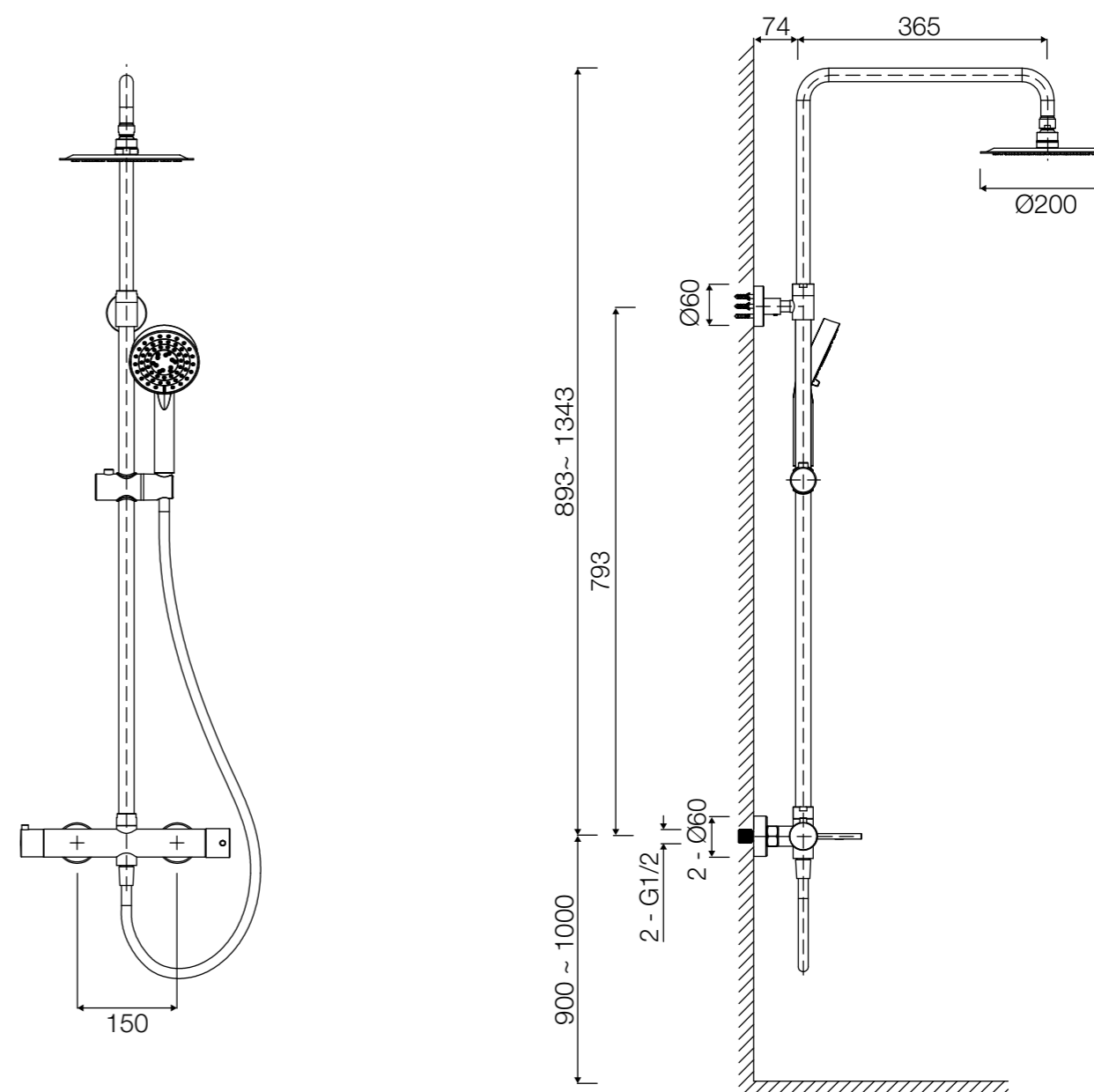

# Diana

## caratteristiche\_characteristics

### COLONNA DOCCIA TERMOSTATICA

- Soffione Tondo Ø 25 cm in acciaio inox spess. 7,5 mm
- Doccetta in ABS
- Flessibile: 150 cm
- Materiale: Ottone
- Finitura: Cromo
- Colonna doccia regolabile
- Supporto scorrevole in ABS

### THERMOSTATIC SHOWER COLUMN

- Stainless steel rain shower head Tondo Ø 25 cm, depth 7,5 mm
- ABS handheld shower head
- Flexible hose: 150 cm
- Material: Brass
- Finish: Chrome
- Adjustable shower column
- Sliding support in ABS

### SET DOCCIA COMPLETO

- Braccio a muro in ottone 40 cm
- Soffione Tondo Ø 20 cm in acciaio inox spess. 7,5 mm
- Incasso doccia in ottone con deviatore a leva
- Doccetta in ABS
- Supporto a muro per doccetta
- Flessibile: 150 cm
- Materiale: Ottone
- Finitura: Cromo

### COMPLETE SHOWER SET

- Brass wall arm 40 cm
- Stainless steel rain shower head Ø 20 cm, depth 7,5 mm
- Brass built-in mixer with lever diverter
- ABS handheld shower head
- Wall support for handheld shower head
- Flexible hose: 150 cm
- Material: Brass
- Finish: Chrome



## colori\_colors



cromo  
chrome

## dettagli\_details

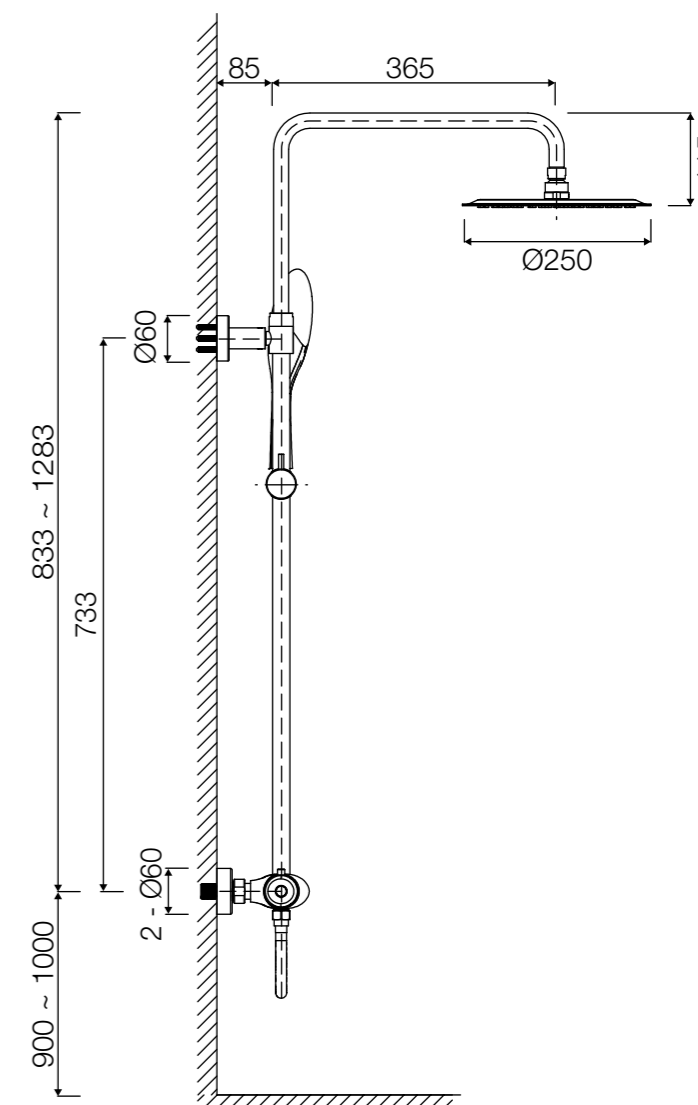
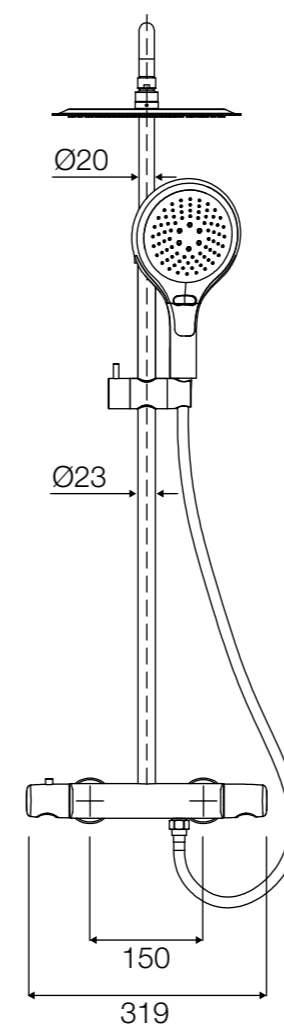

# Set Tondo

## caratteristiche\_characteristics

### SET DOCCIA COMPLETO

- Braccio a muro in ottone 40 cm
- Soffione Tondo Ø 20 cm in acciaio inox spess. 7,5 mm
- Incasso doccia in ottone con deviatore a leva
- Doccetta in ABS
- Supporto a muro per doccetta
- Flessibile: 150 cm
- Materiale: Ottone
- Finitura: Cromo

### COMPLETE SHOWER SET

- Brass wall arm 40 cm
- Stainless steel rain shower head Ø 20 cm, depth 7,5 mm
- Brass built-in mixer with lever diverter
- ABS handheld shower head
- Wall support for handheld shower head
- Flexible hose: 150 cm
- Material: Brass
- Finish: Chrome



## colori\_colors



cromo  
chrome

## dettagli\_details

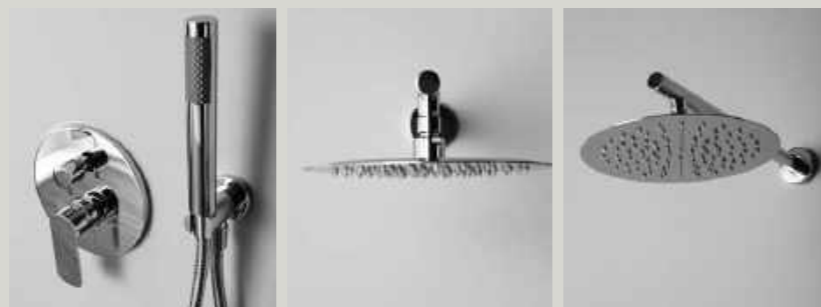

### HKSO103C

Soffione tondo  
Round showerhead  
20x20 cm

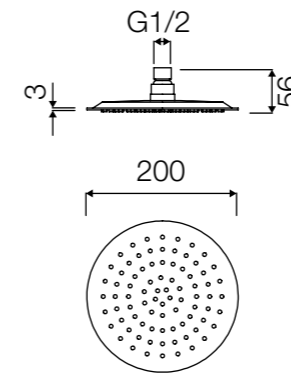

### HKSO104C

Soffione tondo  
Round showerhead  
25x25 cm

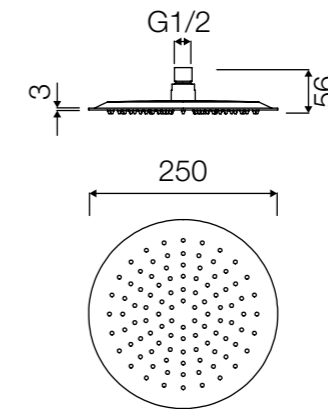

### HKSO105C

Soffione tondo  
Round showerhead  
30x30 cm

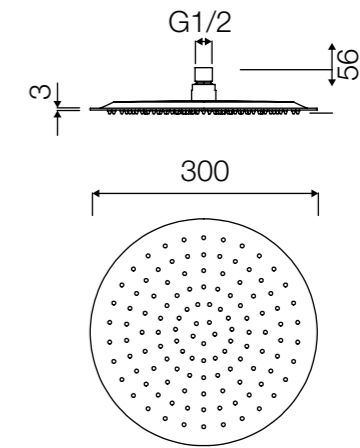

### HKDOC131C

Doccetta tonda  
Round handheld showerhead

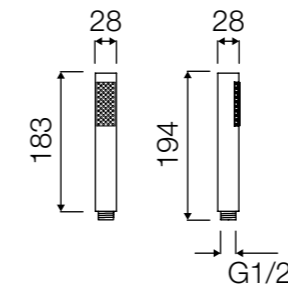

### HKSUP121C

Supporto doccetta tonda  
Round handheld showerhead holder

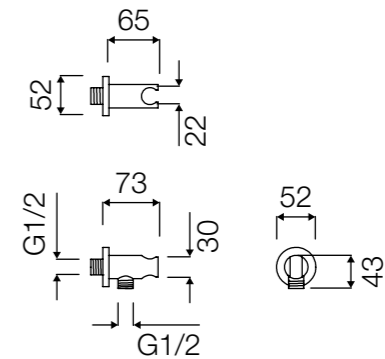

### HKAST111C

Asta a muro tonda  
Round wall-mounted shower arm

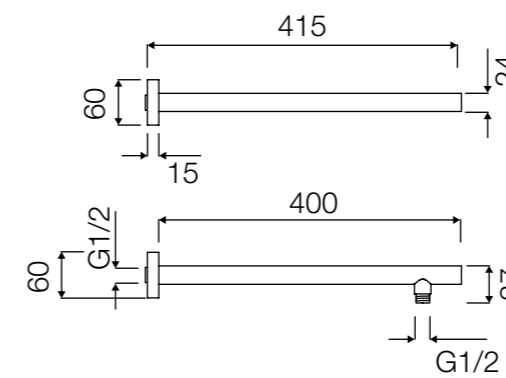

### HKINC143C

Incasso doccia tondo  
Recessed round shower control

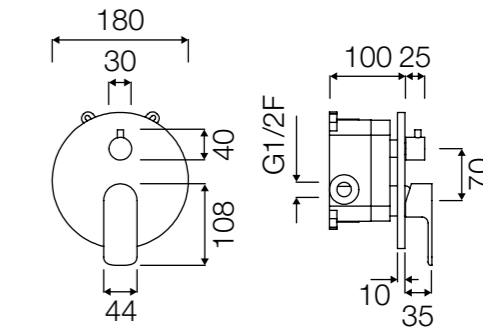

# Angelica

## caratteristiche\_caratteristiche

### COLONNA DOCCIA MECCANICA

- Soffione Rettangolare 23x19 cm (spessore 1,5 cm) in ABS
- Doccetta in ABS
- Flessibile: 150 cm
- Colonna: Ottone
- Finitura: Nero Opaco
- Colonna doccia regolabile
- Supporto scorrevole in ABS

### MECHANICAL SHOWER COLUMN

- ABS rain shower head Rettangolare 23x19 cm (1.5 cm thick)
- ABS handheld shower head
- Flexible hose: 150 cm
- Column: Brass
- Finish: Matt Black
- Adjustable shower column
- Sliding support in ABS



## colori\_colors



nero matt  
black matt

## dettagli\_details

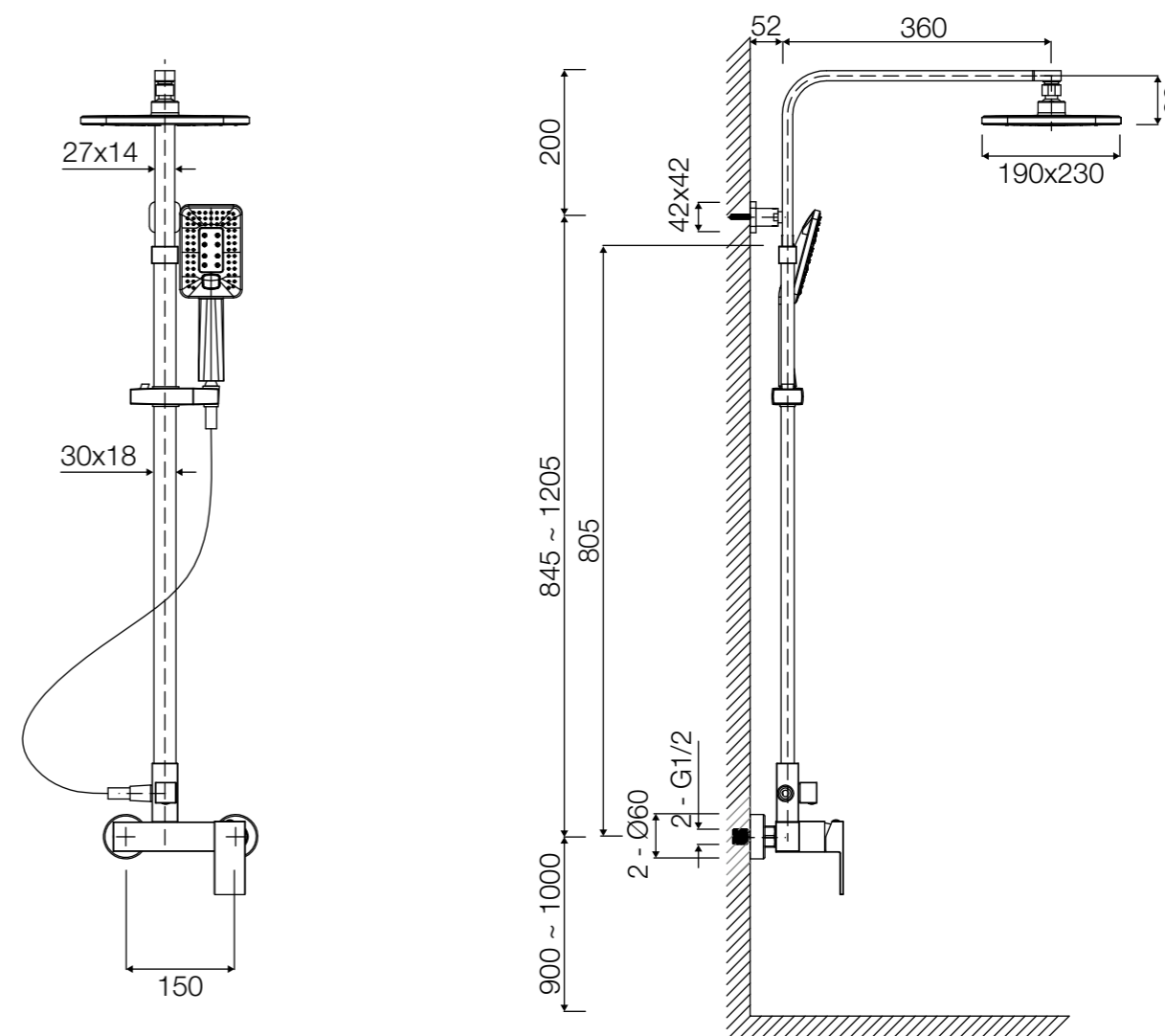
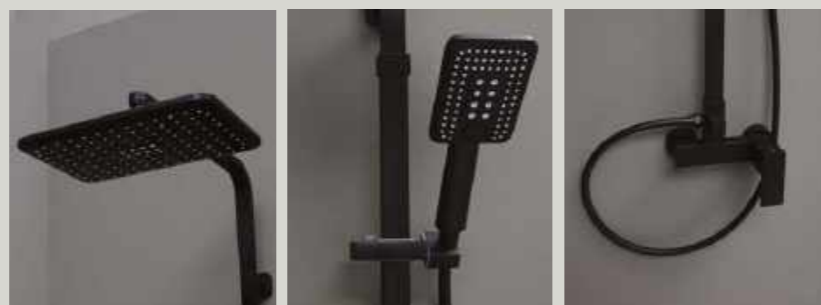

# Set Rettangolare

## black

### caratteristiche\_caratteristiche

#### SET DOCCIA COMPLETO

- Braccio a muro in ottone 38,5 cm
- Soffione Rettangolare 29x19 cm (spessore 1,5 cm) in ABS
- Incasso doccia in ottone con deviatore a leva
- Doccetta in ottone
- Supporto a muro per doccetta in ottone
- Flessibile in PVC: 150 cm
- Materiale: Ottone
- Finitura: Nero Opaco

#### COMPLETE SHOWER SET

- Brass wall arm 38,5 cm
- ABS rain shower head Rettangolare 29x19 cm (1.5 cm thick)
- Brass built-in mixer with lever diverter
- Brass handheld shower head
- Brass wall support for handheld shower head
- Flexible hose PVC: 150 cm
- Material: Brass
- Finish: Matt Black



### colori\_colors



nero matt  
black matt

### dettagli\_details

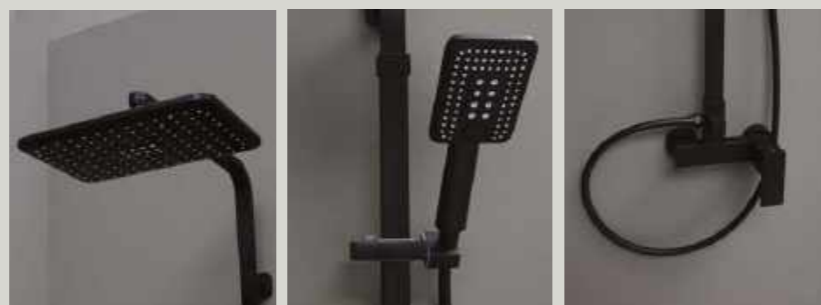

#### HKSO106N

Soffione rettangolare nero  
Black rectangular showerhead  
29x19 cm

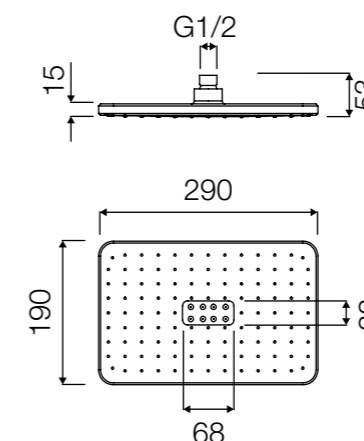

#### HKDOC132N

Doccetta quadra nera  
Black square handheld showerhead

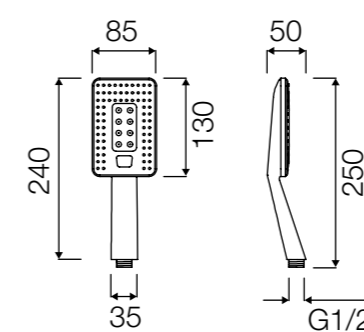

#### HKSUP122N

Supporto doccetta quadro nero  
Black square handheld showerhead holder

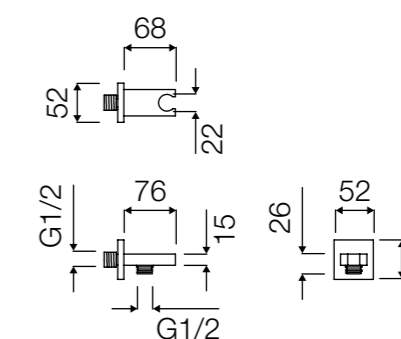

#### HKAST112N

Asta a muro quadra nera  
Black square wall-mounted shower arm

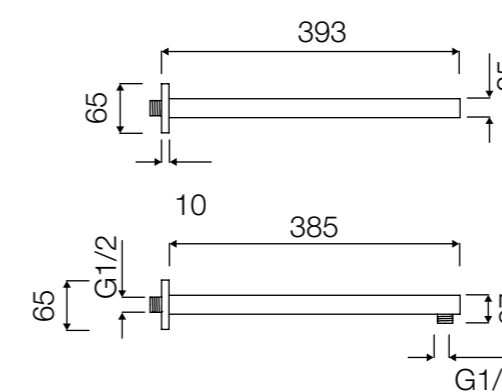

#### HKINC144N

Incasso doccia quadro nero  
Black square recessed shower control

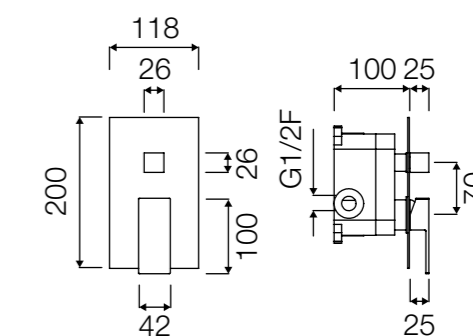

# Tritone

## caratteristiche\_caratteristiche

COLONNA DOCCIA MECCANICA  
 - Soffione Tondo Ø 22,5 cm  
 (spessore 1,2 cm) in ABS  
 - Doccetta in ABS  
 - Flessibile: 150 cm  
 - Colonna: Ottone  
 - Finitura: Nero Opaco  
 - Colonna doccia regolabile  
 - Supporto scorrevole in ABS

MECHANICAL SHOWER COLUMN  
 - ABS rain shower head Tondo  
 Ø 22,5 cm (1.2 cm thick)  
 - ABS handheld shower head  
 - Flexible hose: 150 cm  
 - Column: Brass  
 - Finish: Matt Black  
 - Adjustable shower column  
 - Sliding support in ABS



## colori\_colors



nero matt  
 black matt

## dettagli\_details

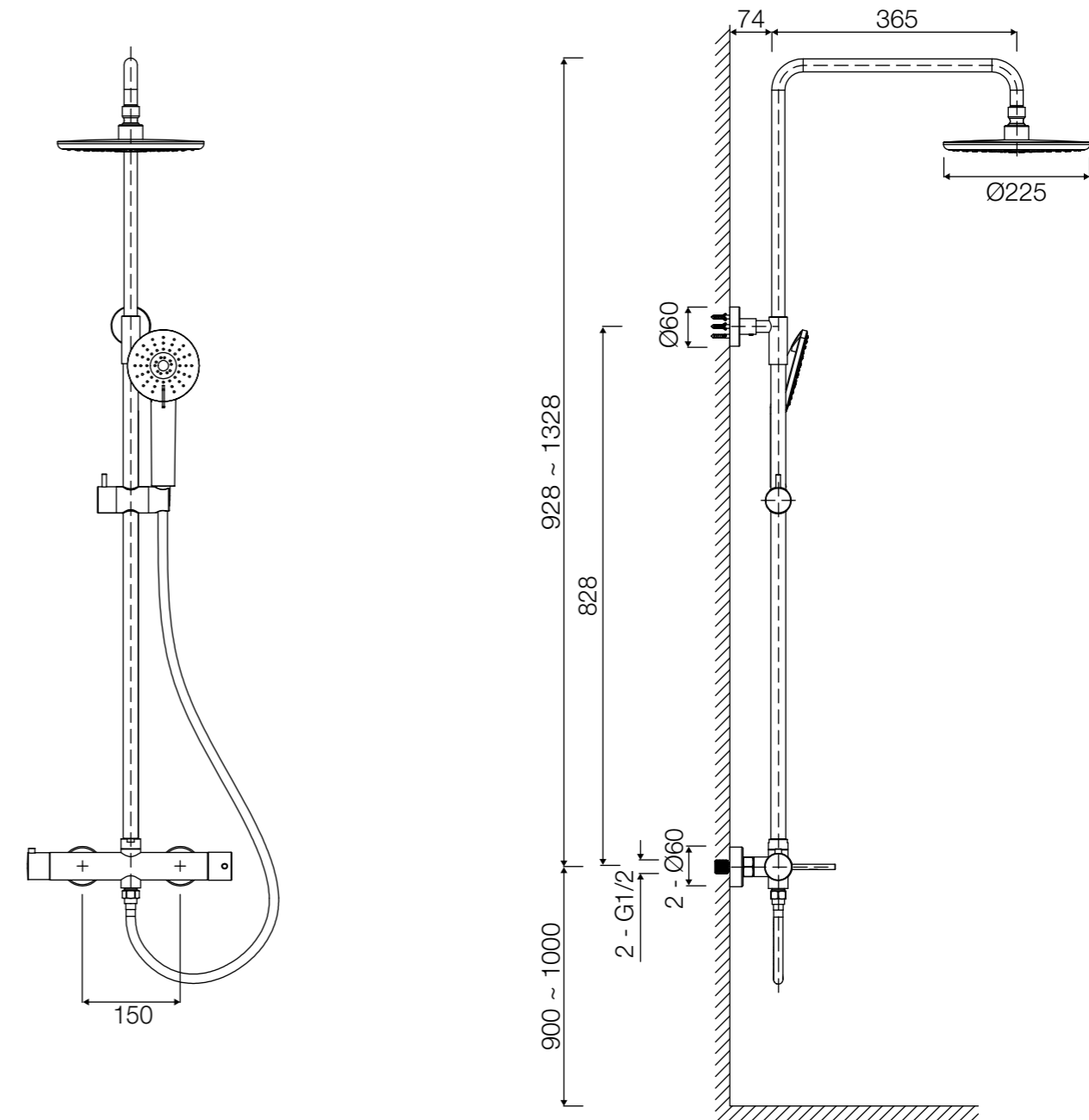

# Set Tondo

## black

### caratteristiche\_caratteristiche

#### SET DOCCIA COMPLETO

- Braccio a muro in ottone 40 cm
- Soffione Tondo Ø 23 cm (spessore 1,2 cm) in ABS
- Incasso doccia in ottone con deviatore a leva
- Doccetta in ABS
- Supporto a muro per doccetta
- Flessibile: 150 cm
- Materiale: Ottone
- Finitura: Nero Opaco

#### COMPLETE SHOWER SET

- Brass wall arm 40 cm
- Stainless steel rain shower head Tondo Ø 23 cm (spessore 1,2 cm) in ABS
- Brass built-in mixer with lever diverter
- ABS handheld shower head
- Wall support for handheld shower head
- Flexible hose: 150 cm
- Material: Brass
- Finish: Matt Black



### colori\_colors



nero matt  
black matt

### dettagli\_details



#### HKSOE107N

Soffione tondo nero  
Black round showerhead  
20x20 cm

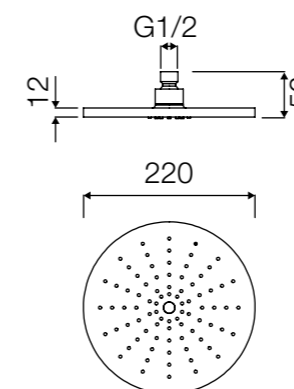

#### HKDOC133N

Doccetta tonda nera  
Black round handheld showerhead

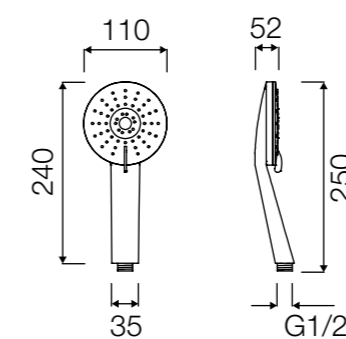

#### HKSUP123N

Supporto doccetta tondo nero  
Black round handheld showerhead holder

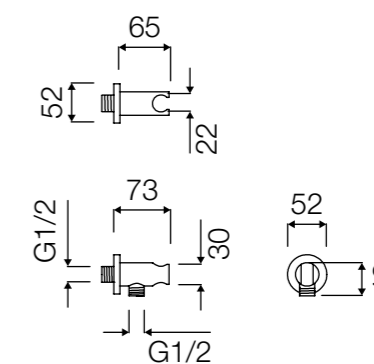

#### HKAST13N

Asta a muro tonda nera  
Black round wall-mounted shower arm

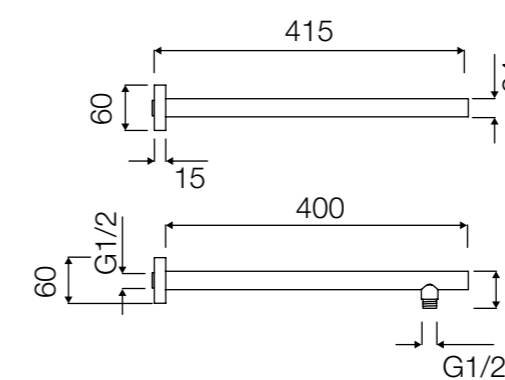

#### HKINC145N

Incasso doccia tondo nero  
Black round recessed shower control

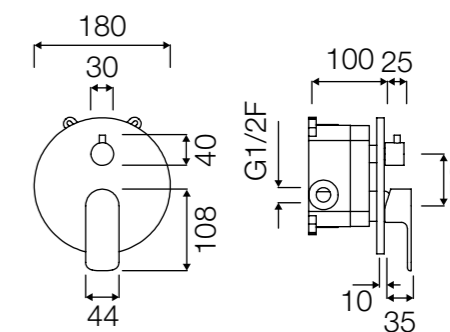

# accessori

accessories

---

## accessori

accessories

---

<b>MANIGLIE</b>	<b><u>350</u></b>
handles	
<b>ANGOLI DI GIUNZIONE</b>	<b><u>350</u></b>
corner connection	
<b>GRUPPI DI SCORRIMENTO</b>	<b><u>351</u></b>
sliding systems	
<b>CERNIERE</b>	<b><u>352</u></b>
hinges	
<b>GOCCIOLATOI</b>	<b><u>352</u></b>
drippers	
<b>PERNI</b>	<b><u>353</u></b>
pins	
<b>SNODI</b>	<b><u>353</u></b>
joints	
<b>GUARNIZIONI</b>	<b><u>354</u></b>
gaskets	
<b>PROFILI</b>	<b><u>356</u></b>
profiles	
<b>ASTE DI FISSAGGIO</b>	<b><u>357</u></b>
support arm	
<b>VETRI</b>	<b><u>358</u></b>
glasses	
<b>IMBALLI</b>	<b><u>358</u></b>
packaging box	



## maniglie / handles

## TM1



Per / For Art.  
EASYFLEX - EASYPSC50  
QUICK - PSCQUICK

## TM2



Per / For Art.  
ECOPSC50 - ECO

## TM3



Per / For Art.  
RAPID - PSCRAPID

## TM4



Per / For Art.  
FPSL60 - FPB40 - FS40 - TPB72  
TPS35 - 8MILL INFINITY - SWING

## TM5



Per / For Art.  
TEPB43 - 8PSC15

## TM6



Per / For Art.  
NSALOOON

## TM7



Per / For Art.  
TVB61

## TM8



Per / For Art.  
SWING NERA

## TM9



Per / For Art.  
SWING ALLUMINIO SPAZZOLATO

## angoli di giunzione / corner connection

## TAG1

Angolo di giunzione per  
box doccia / Corner connection  
for shower enclosure



Per / For Art.  
ECO

## TAG2

Angolo di giunzione per  
box doccia / Corner connection  
for shower enclosure



Per / For Art.  
EASYFLEX - QUICK

## TAG3

Angolo di giunzione per  
box doccia / Corner connection  
for shower enclosure



Per / For Art.  
RAPID

## gruppi di scorrimento / sliding systems

## GSSUP

Gruppo di scorrimento superiore  
con regolazione per porte  
scorrevoli / Superior sliding  
mechanism with adjustment  
for the sliding doors



Per / For Art.  
FS40 - FPSC50  
FLEX - FPSC57

## GSUPNE

Gruppo di scorrimento superiore  
con regolazione per porte  
scorrevoli / Superior sliding  
mechanism with adjustment  
for the sliding doors



Per / For Art.  
PSCRAPID - RAPID

## GSSUPECO

Gruppo di scorrimento superiore  
con regolazione per porte  
scorrevoli / Superior sliding  
mechanism with adjustment  
for the sliding doors



Per / For Art.  
ECO - ECOPSC50

## GSSUPEASY

Gruppo di scorrimento superiore  
con regolazione per porte  
scorrevoli / Superior sliding  
mechanism with adjustment  
for the sliding doors



Per / For Art.  
QUICK - PSCQUICK  
EASYFLEX - EASYPSC50

## GS8PSC15

Gruppo di scorrimento superiore  
con regolazione per porte  
scorrevoli / Superior sliding  
mechanism with adjustment  
for the sliding doors



Per / For Art.  
8PSC15

## GSINF

Gruppo di scorrimento inferiore  
con sgancio rapido per porte  
scorrevoli / Inferior sliding  
mechanism with quick release  
for the sliding doors



Per / For Art.  
FS40 - FLEX  
FPSC50 - FPSC57

## GSINFNE

Gruppo di scorrimento inferiore  
con sgancio rapido per porte  
scorrevoli / Inferior sliding  
mechanism with quick release  
for the sliding doors



Per / For Art.  
RAPID - PSCRAPID

## GSINFECO

Gruppo di scorrimento inferiore  
con sgancio rapido per porte  
scorrevoli / Inferior sliding  
mechanism with quick release  
for the sliding doors



Per / For Art.  
ECO - ECOPSC50

## GSINFEASY

Gruppo di scorrimento inferiore  
con sgancio rapido per porte  
scorrevoli / Inferior sliding  
mechanism with quick  
release for the sliding doors



Per / For Art.  
EASYFLEX - EASYPSC50

## GSCFPS30

Gruppo di scorrimento  
per porta a soffietto /  
Sliding mechanism  
for folding door



Per / For Art.  
FPS30

## cerniere / hinges

TC1



Per / For Art.  
FPB40

TC2



Per / For Art.  
TVB61

TC3



Per / For Art.  
TEPB43

TC4



Per / For Art.  
WALK-IN AS

TC5



Per / For Art.  
TPB72

TC6



Per / For Art.  
TPS35

TC7



Per / For Art.  
8MILL INFINITY

## perni / pins

TP1

Coppia perni inferiori /  
Pair of lower pins



Per / For Art.  
FPSL60

TP2

Perno singolo superiore /  
Single upper pin



Per / For Art.  
FPSL60

TP3

Perno inferiore /  
Lower pin



Per / For Art.  
SWING CROMO - NSALOON

TP4

Perno superiore /  
Upper pin

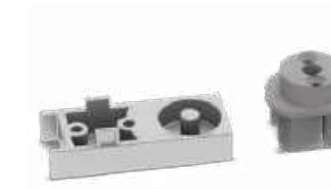

Per / For Art.  
SWING CROMO - NSALOON

TP5

Perno inferiore /  
Lower pin



Per / For Art.  
SWING NERA

TP6

Perno superiore /  
Upper pin



Per / For Art.  
SWING NERA

TP7

Perno inferiore /  
Lower pin



Per / For Art.  
SWING ALLUMINIO SPAZZOLATO

TP8

Perno superiore /  
Upper pin



Per / For Art.  
SWING ALLUMINIO SPAZZOLATO

## gocciolatoi / drippers

TGOCC1

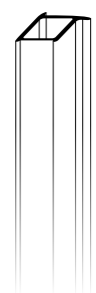

Per / For Art.  
8PSC15 - QUICK - PSCQUICK

TGOCC2

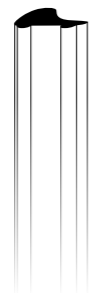

Per / For Art.  
TEPB43 - TPS35 - SWING CROMO  
NSALOON - INFINITY

TGOCC3



Per / For Art.  
SWING NERA

TGOCC4

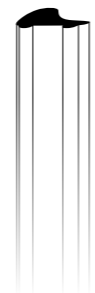

Per / For Art.  
SWING ALLUMINIO SPAZZOLATO

## snodi / joints

TS1



Per / For Art.  
FPS30

TS2



Per / For Art.  
TSV051 - TSV052

TS3



Per / For Art.  
TSV052

## guarnizioni / gaskets

guarnizioni sottoporta per box doccia 6 mm / door bottom sweep for 6 mm shower box

### TGS1

Guarnizione sotto porta /  
Door bottom sweep

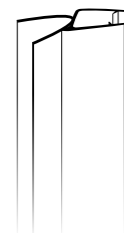

**TGS1** Per / Art.  
TVB61 - FPB40 - FPSL60  
TEPB43 - TPS35 - TPB72

### TGS2

Guarnizione sotto porta /  
Door bottom sweep

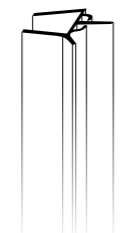

**TGS2** Per / Art.  
FPS30

### TGS3

Guarnizione sotto porta /  
Door bottom sweep

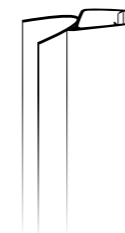

**TGS3** Per / Art.  
TVS51 - TVS52

### TGS4

Guarnizione sotto porta /  
Door bottom sweep

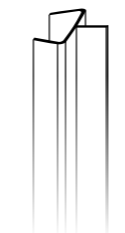

**TGS4** Per / Art.  
QUICK - PSCQUICK

### TGS5

Guarnizione sotto porta /  
Door bottom sweep

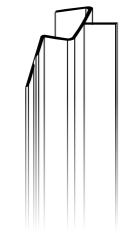

**TGS5** Per / Art.  
N SALOON - SWING CROMO  
SWING ALLUMINIO SPAZZOLATO

### TGS6

Guarnizione sotto porta /  
Door bottom sweep

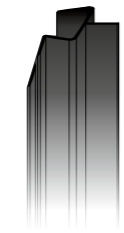

**TGS6** Per / Art.  
SWING NERA

guarnizioni laterali per box doccia 6 mm / door lateral sweep for 6 mm shower box

### TGL1

Guarnizione laterale porta /  
Door lateral sweep



**TGL1** Per / Art.  
TVB61 - TEPB43 - TPB72 -  
FPB40 (100 - 110 - 120)

### TGL2

Guarnizione laterale porta /  
Door lateral sweep

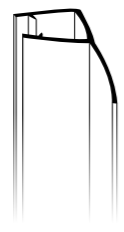

**TGL2** Per / Art.  
FS40 - ECO - ECOPSC50

### TGL3

Guarnizione laterale porta /  
Door lateral sweep



**TGL3** Per / Art.  
EASYFLEX - EASYPSC50 - QUICK  
PSCQUICK - RAPID - PSCRAPID

### TGL4

Guarnizione laterale porta /  
Door lateral sweep



**TGL4** Per / Art.  
TPS35

### TGL5

Guarnizione laterale porta /  
Door lateral sweep

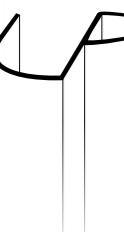

**TGL5** Per / Art.  
FPB40 (70 - 80 - 90)

### TGL6

Guarnizione laterale porta /  
Door lateral sweep

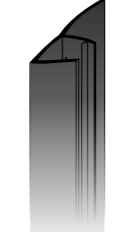

**TGL6** Per / Art.  
RAPID - PSCRAPID

guarnizioni calamitate per box doccia 6 mm / door magnetic sweep for 6 mm shower box

### TGC1

Guarnizione calamitata porta /  
Door magnetic sweep



**TGC1** Per / Art.  
FPSL60 - TEPB43 - TVB61  
TPB72 - FS40 - NSALOON - SWING

### TGC2

Guarnizione calamitata porta /  
Door magnetic sweep



**TGC2** Per / Art.  
QUICK - EASYFLEX  
SWING

### TGC3

Guarnizione calamitata porta /  
Door magnetic sweep

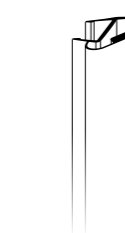

**TGC2** Per / Art.  
PSCQUICK - EASYPSC50

### TGC4

Guarnizione calamitata porta /  
Door magnetic sweep

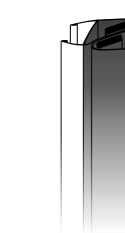

**TGC4** Per / Art.  
RAPID

### TGC5

Guarnizione calamitata porta /  
Door magnetic sweep



**TGC5** Per / Art.  
PSCRAPID

### TGC6

Guarnizione calamitata porta /  
Door magnetic sweep

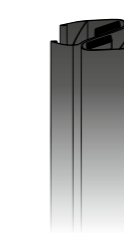

**TGC6** Per / Art.  
SWING - RAPID

### TGC7

Guarnizione calamitata porta /  
Door magnetic sweep



**TGC7** Per / Art.  
PSCRAPID

guarnizioni per box doccia 8 mm / door sweep for 8 mm shower box

### T8GS1

Guarnizione sotto porta /  
Door bottom sweep

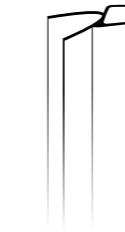

**T8GS1** Per / Art.  
8MILL INFINITY

### T8GL1

Guarnizione laterale porta /  
Door lateral sweep

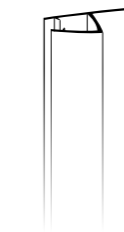

**T8GL1** Per / Art.  
8MILL INFINITY

### T8GL2

Guarnizione laterale porta /  
Door lateral sweep

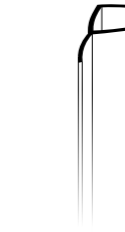

**T8GL2** Per / Art.  
8PSC15

### T8GC1

Guarnizione calamitata porta /  
Door magnetic sweep

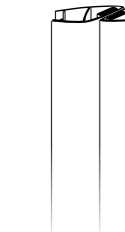

**T8GC1** Per / Art.  
8MILL INFINITY

### T8GC2

Guarnizione calamitata porta /  
Door magnetic sweep



**T8GC2** Per / Art.  
8PSC15

### T8GC3

Guarnizione calamitata fisso laterale /  
Door magnetic lateral fixed sweep



**T8GC3** Per / Art.  
8KLF

## profili / profiles

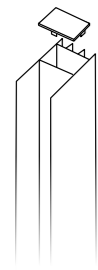

### NTPA01

Profilo allungabile per box doccia / Adjustable profile for the shower enclosures

Per / For Art.  
TEPB43 - TPS35 - TELF

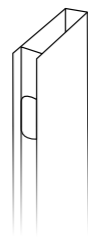

### NTPA04

Profilo allungabile per box doccia / Adjustable profile for the shower enclosures

Per / For Art.  
TVB61

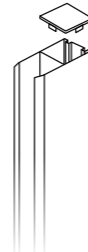

### NTPA05

Profilo allungabile per box doccia / Adjustable profile for the shower enclosures

Per / For Art.  
TPB72 - TBLF

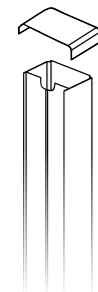

### NTPA06

Profilo allungamento / Adjustable profile

Per / For Art.  
8PSC15 - 8KLF



### NTPA07

Profilo allungamento / Adjustable profile

Per / For Art.  
8MILL INFINITY



### TPAEF11

Profilo allungabile per box doccia / Adjustable profile for the shower enclosures

Per / For Art.  
QUICK - PSCQUICK - EASYPSC50  
FPS30 - FPSL60 - FPB40 - FS40  
EASYFLEX - FISSO



### TPAEF11NE

Profilo allungabile per box doccia / Adjustable profile for the shower enclosures

Per / For Art.  
RAPID - PSCRAPID



### TPA12

Profilo allungabile per box doccia / Adjustable profile for the shower enclosures

Per / For Art.  
NSALOON

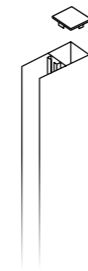

### TPA10

Profilo allungabile per box doccia / Adjustable profile for the shower enclosures

Per / For Art.  
SWING CROMO  
PARETE CROMO



### TPA10NE

Profilo allungabile per box doccia / Adjustable profile for the shower enclosures

Per / For Art.  
SWING NERA - PARETE NERA



### TPA10AS

Profilo allungabile per box doccia / Adjustable profile for the shower enclosures

Per / For Art.  
SWING ALLUMINIO SPAZZOLATO  
PARETE ALLUMINIO SPAZZOLATO

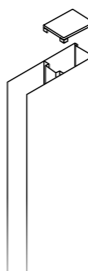

### TPAE09

Profilo allungamento / Adjustable profile

Per / For Art.  
ECOLATO

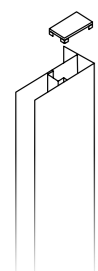

### TPA13

Profilo allungabile per box doccia / Adjustable profile for the shower enclosures

Per / For Art.  
ECOPSC50

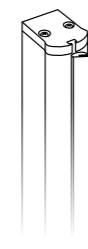

### NTPC01

Profilo chiusura / Closing profile

Per / For Art.  
TEPB43 - TPS35



### NTPC02

Profilo chiusura / Closing profile

Per / For Art.  
8PSC15



### NTPC03

Profilo chiusura / Closing profile

Per / For Art.  
TEPB43 - TPS35 - TPB72  
SWING - INFINITY



### NTPC03NE

Profilo chiusura / Closing profile

Per / For Art.  
SWING NERA



### NTPC03AS

Profilo chiusura / Closing profile

Per / For Art.  
SWING ALLUMINIO SPAZZOLATO

## aste di fissaggio / support arm

### TAF1

Asta di fissaggio tagliabile, snodabile cm 120 / Cuttable, adjustable support arm cm 120



TAF1 Per / Art.  
N8PAR53 - PARETE

### TAF2

Asta di fissaggio per lato fisso cm 22 / The support arm for the fixed panel cm 22



TAF2 Per / Art.  
TEPB43

### TAF3

Asta di fissaggio per lato fisso cm 29 / The support arm for the fixed panel cm 29



TAF3 Per / Art.  
TEPB43

### TAF4

Asta di fissaggio per lato fisso cm 40 / The support arm for the fixed panel cm 40



TAF4 Per / Art.  
TEPB43

### TAF5

Asta di fissaggio per lato fisso cm 55 / The support arm for the fixed panel cm 55



TAF5 Per / Art.  
TEPB43

### TAF6

Asta di fissaggio per lato fisso cm 57,7 / The support arm for the fixed panel cm 57,7



TAF6 Per / Art.  
TELF

### TAF7

Asta di fissaggio per lato fisso cm 55 / The support arm for the fixed panel cm 55



TAF7 Per / Art.  
SALFIS

### TAF8

Asta di fissaggio per lato fisso cm 65 / The support arm for the fixed panel cm 65



TAF8 Per / Art.  
SALFIS

### TAF9

Asta di fissaggio per lato fisso cm 75 / The support arm for the fixed panel cm 75



TAF9 Per / Art.  
SALFIS

### TAF10

Asta di fissaggio per lato fisso cm 85 / The support arm for the fixed panel cm 85



TAF10 Per / Art.  
SALFIS

### TAF11

Asta di fissaggio tagliabile, snodabile cm 120 / Cuttable, adjustable support arm cm 120



TAF11 Per / Art.  
PARETEAS - WALK-IN AS

### TAF12

Asta di fissaggio tagliabile cm 120 / Cuttable support arm cm 120



TAF12 Per / Art.  
N8PAR53W

### TAF13

Asta di fissaggio tagliabile, snodabile cm 120 / Cuttable, adjustable support arm cm 120



TAF3 Per / Art.  
PARETENE

### TAF14

Asta di fissaggio per TSV50 cm 88 / The support arm for the fixed panel cm 88



TAF14 Per / Art.  
TSV50

### TAF15

Asta di fissaggio tagliabile, snodabile cm 120 / Cuttable, adjustable support arm cm 120



TAF15 Per / Art.  
N8PAR53 GRAFITE

### TAF16

Asta di fissaggio tagliabile, snodabile cm 120 / Cuttable, adjustable support arm cm 120



TAF16 Per / Art.  
N8PAR53 ORO

### TAF17

Asta di fissaggio tagliabile, snodabile cm 120 / Cuttable, adjustable support arm cm 120



TAF17 Per / Art.  
N8PAR53 BRONZO

## vetri / glasses

vetro temperato da 6 mm e 8 mm / tempered glass of 6 mm and 8 mm



easy clean

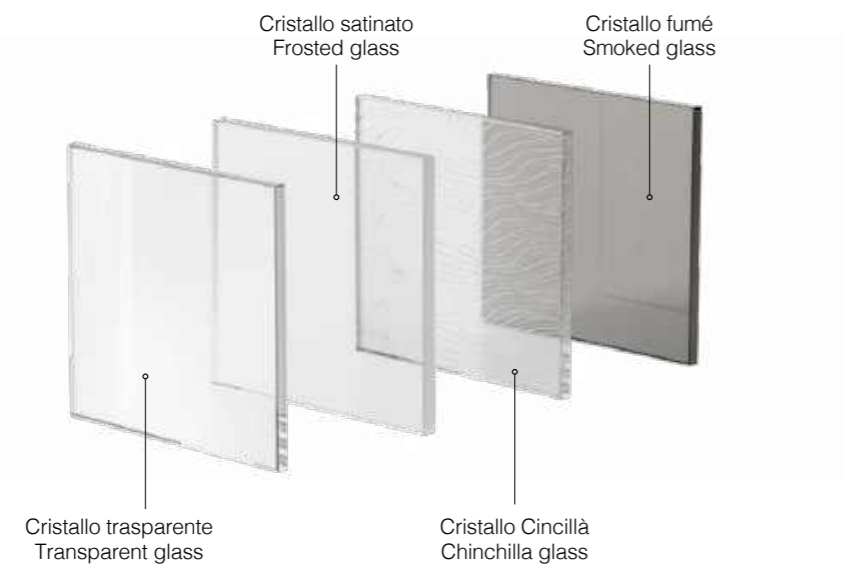

## imballi / packaging box

Tutte le colonne doccia sono contenute in una valigetta in cartone riciclato **L 90 x H 46 x P 14,5 cm.**

La confezione del prodotto è robusta per garantire che non ci siano danni dovuti a urti o perdite durante il trasporto ed è fornita con tutti i kit necessari per una facile installazione.

All shower columns are packed in a recycled cardboard case **L 90 x H 46 x P 14,5 cm.**

The product packaging is solid to prevent damage from bumps and leaks during transportation and is furnished with all the necessary kits for easy installation.



Print  
Telligraf

© Colavene spa 11/2023

\_COLACRIL si riserva il diritto di apportare modifiche ai prodotti descritti in questo catalogo. I manufatti ceramici possono subire variazioni dimensionali. Per ogni aspetto tecnico e dimensionale fare riferimento alla documentazione tecnica aziendale e relativi aggiornamenti. I colori e i materiali riprodotti nelle immagini stampate hanno un valore indicativo. COLACRIL declina ogni responsabilità derivante da eventuali inesattezze di stampa e/o da errori sulle caratteristiche dei prodotti forniti.

\_COLACRIL reserves the right to make changes to the products described in this catalog. Ceramic items may be subject to dimensional variations. For all technical and dimensional aspects, please refer to the company's technical documentation and relative updates. The colors and materials reproduced in the printed images are indicative only. COLACRIL declines all responsibility for any printing inaccuracies and/or errors in the characteristics of the products supplied.

# Colacril

## COLACRIL

Un Brand di Colavene S.p.A.

Sede operativa  
via Delle Industrie, 1  
01033 Civita Castellana (VT) Italy

Sede legale  
Via Flaminia km 58,600  
01033 Civita Castellana (VT) Italy

Tel. +39 0761 595595  
Fax. +39 0761 517595  
colacril@colacril.it

LE CINQUE ANIME DI COLAVENE

COLAVENE AXA TAMANACO Colacril L'AZZURRO

C